



M.U.

Miskatonic University
LIBRARY ASSOCIATION

**MONOGRAPH
#0356**

*Miskatonic University
Library Association*

monographs are works in which the author has performed most editorial and layout functions. The trustees have deemed that this work offers significant value and entertainment to our patrons.

Other monographs are available at www.chaosium.com



Once Men

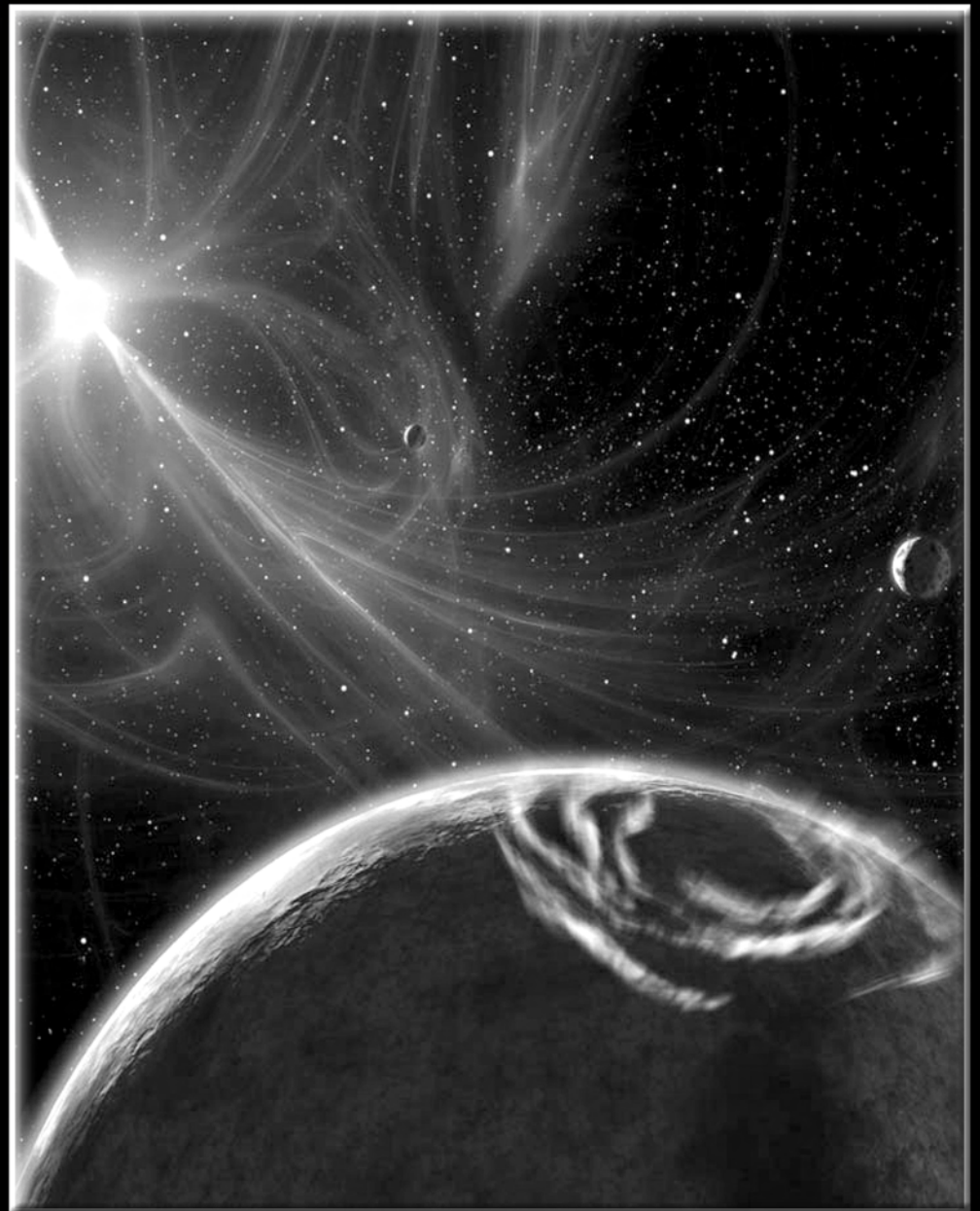

**Science Fiction Rules &
Adventures for Call of Cthulhu**



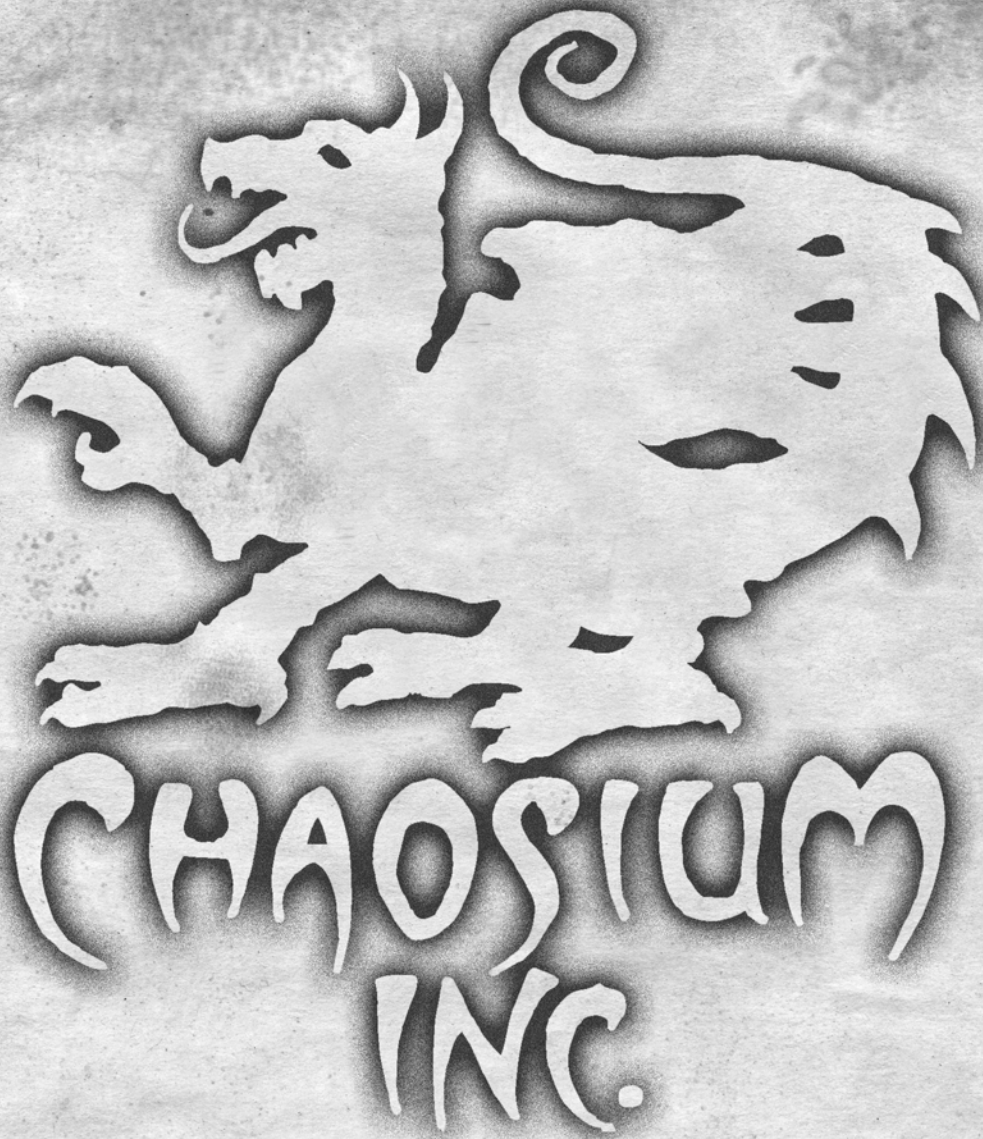

**We hope you enjoy
this Chaosium publication,
and thank you for purchasing this
PDF from www.chaosium.com.**

Once Men

Dr. Michael C. LaBossiere
ontologist@aol.com

Copyright 2008 Dr. Michael C.
LaBossiere

Any similarity between characters in *Once Men* and persons living, dead, or undead is strictly coincidental.

Reproduction of the material within this work for the purpose of personal or corporate profit by photographic, electronic or other methods of retrieval is strictly prohibited. Permission is given to copy the maps and handouts for personal use. *Raising Up* is designed for use with Chaosium's *Call of Cthulhu* Role-Playing Game.

Special thanks to: Dave Herman, Bridgette Jeffries, Dan Lane, Ron Lynn, Douglas Moore, Trent Watson

Introduction

This work provides science fiction rules for *Call of Cthulhu* as well as four adventures set in the future. Naturally enough, writing a science fiction supplement for a universe based on H.P. Lovecraft's Cthulhu Mythos proved to be a challenging endeavor.

Lovecraft does include references to the future in some of his stories. Four of these are the "Shadow Out of Time", "Through the Gates of the Silver Key", "Beyond the Wall of Sleep", and "In the Walls of Eryx."

In the "Shadow out of Time", Lovecraft provides a few tantalizing comments about the future of humanity. As the story recounts, Nathaniel Wingate Peaslee's mind is exchanged with that of one of the Great Race of Yith. While his mind is in the distant past, he encounters other human minds from various epochs. Among these are three men from the future. The first is Nevil Kingston-Brown, an "Australian

physicist...who will die in 2,518 A.D." The second is Yiang-Li who is "a philosopher from the cruel empire of Tsan-Chan, which is to come in 5,000 A.D." The third is Nug-Soth, "a magician of the dark conquerors of 16,000 A.D."

The story also related that a hardy coleopterous race would be humanity's immediate successor on earth. Unfortunately for that race of beetles, they will eventually be taken over by the minds of the Great Race. The final race on earth, at least according to the story, will be an arachnid one. While no specific dates are provided, it is suggested that these events lie in the far distant future.

In "Through the Gates of the Silver Key", Lovecraft mentions that Pickman Carter "would use strange means in repelling the Mongol hordes from Australia" in 2169. This is the only mention of future events in the story.

In "Beyond the Wall of Sleep", Lovecraft also mentions the cruel empire of Chan-Tsan. In this story, the empire is said to arise 3,000 years after the winter of 1900-1901.

The short story "In the Walls of Eryx", tells of a future in which humanity has landed on Venus in order to mine crystals. Of course, there is the obvious worry that this story does not seem to be part of the Mythos and hence cannot be taken as providing more insight into the future hinted at in the other two stories.

Some have taken the stories "The Crawling Chaos", "Nyarlathotep", and "The Fungi From Yugoth" to suggest that Nyarlathotep will bring about the end of humanity and perhaps the earth. No specific dates are provided for these events, but (given "The Shadow Out of Time") the end of man must take place after 16,000 A.D. and the earth must endure at least through the time of the arachnid race.

This lack of detail about the future was both a boon and a bane when it came to



writing this work. On the negative side, the lack of detail means that the future had to be created almost whole cloth and with few guides as to what Lovecraft might have intended or envisioned. On the positive side, the lack of details allowed a broad field in which to operate. Since I have been consistent with the few available details and the spirit of Lovecraft's stories, it would be difficult for a critic to plausibly say "that is not what Lovecraft would have intended."

In this work, I do not even pretend to try to guess as to what Lovecraft truly had in mind in regards to the future of man. My main goal has been to present a future consistent with Lovecraft's stories and the spirit of his works.

In terms of the game aspects, I elected to stick with two key assumptions of the *Call of Cthulhu* game. First, it is assumed that while man is truly nothing before the ultimate power of the Mythos, humanity is still worth protecting. While mankind cannot be permanently saved, moments of peace and islands of sanity can be carved out of the uncaring and horrific universe.

Second, it is not the "stuff" (weapons, vehicles, and gadgets) that matters most. Rather the story and the role-playing are what matter. The future setting is just that—a setting intended to provide a new twist to the game. Naturally, it is tempting to overload a game set in the future with amazing technology. However, I think that *Alien*, *Firefly* and even *Star Trek* have shown that science fiction is often at its best when the technology is a backdrop for the characters and plot rather than the star of the show. As in the standard *Call of Cthulhu* game, it is clever thinking, good planning and some luck that will win the day. To change a classic question just a bit: "what happens when you nuke Cthulhu from orbit?" The answer is, of course, "he reforms, but now he is radioactive. Make a Sanity check."

Game Mechanics

This following provides an extension to the standard *Call of Cthulhu* game rules. As such, while some additions and modification have been made to the rules, the basics remain the same.

Characters

The following section provides a guide to creating characters. It includes new professions and skills for this game setting.

Character Creation

Basic character creation is done as per the standard *Call of Cthulhu* rules. To be specific, a character is rolled using the normal methods and then the player selects an occupation and allocates the relevant points for skills.

Old Occupations

The standard occupations from *Call of Cthulhu* are generally available to investigators in this setting. Some of them, such as Farmer or Tribal Member, will obviously be far less common in the future. The Keeper might also wish to modify some of the occupations to reflect specific differences between the game settings.

New Occupations

The following are new occupations for this setting.

Atmosphere Craft Pilot

Description: While vessels will travel the void, many more will remain within the atmosphere and will need skilled pilots to guide them safely. While these pilots all fly aircraft, they often fly through strange atmospheres under alien skies.

Occupation Skills: Astronomy, Electrical Repair, Electronics, Mechanical Repair, Navigate, Operate Heavy Machinery, Pilot Aircraft and any one other skill as a specialty.

Asteroid Prospector/Miner

Description: Asteroid prospectors/miners have a dangerous and potential lucrative career exploring and mining asteroids and other small bodies in space. They are similar in some ways to the prospectors of old in that they tend to be ambitious and self-reliant. Unlike their historical predecessors, they need to possess technical skills in order to even survive the challenges of their occupation.

Occupation Skills: Electrical Repair, Electronics, Low/Zero Gravity Operations, Low Gravity Mining, Mechanical Repair, Navigate, Operate Heavy Machinery, Planetology

Computer Specialist

Description: Computers are an integral and critical part of all aspects of life and hence experts are needed to program, repair, and design them. While anyone with a modicum of intelligence can use a typical computer, special skills are required to deal with the more technical aspects of these machines. Occupation Skills: Computer Use, Electronics, Electrical Repair, Library Use, and any two other skills as personal specialties.

Gate System Engineer

Description: Gate System Engineers are tasked with maintaining, repairing, and operating the Markelson Gate Systems that are the heart of human starships. They are also charged with protecting the secret of the Gate System.

Occupation Skills: Biology, Computer Use, Electrical Repair, Electronics, Gate System Operation, Library Use, Mechanical Repair, Medicine, and Physics.

Marine

Description: Although the use of the term “marine” is a misnomer, the tradition of

calling soldiers aboard ships and naval installations “marines” carried over into space. Marines, in this sense, are combat troops who have been specially trained in low and zero gravity combat. While other soldiers receive training in such combat, they generally are not as focused in this area as marines.

Occupation Skills: Dodge, First Aid, Hide, Listen, Mechanical Repair, Rifle, Sneak, Low/Zero Gravity Operations

Orbital Engineer

Description: The orbital engineers are responsible for the design, construction, and maintenance of orbital assets such as ships, satellites, and stations. The orbital engineer’s life can be a difficult one and sometimes a short one: accidents are rare but typically fatal in the harsh and unforgiving environment of space.

Occupation Skills: Chemistry, Computer Use, Electrical Repair, Electronics, Library Use, Low/Zero Gravity Operations, Mechanical Repair, Physics, and one Space Engineering skill as a specialization.

Planetary Engineer

Description: Planetary engineers design and maintain ground based structures. They range from experts with advanced degrees to individuals who just have a knack for making structures that will not fall down.

Occupation Skills: Chemistry, Computer Use, Electrical Repair, Electronics, Geology, Library Use, Mechanical Repair, Physics, and one Planetary Engineering skill as a specialty.

Space/Planetary Scientist

Description: The planetary scientist specializes in the study of certain aspects of planets, such as their geology, ecology, and so forth. The space scientist specializes in the study of space and the objects within it, such as comets, stars, and planets. Her



studies are typically on a more general scale than the planetary scientist, who typically focuses on one planet or even one small aspect of it, but space scientists sometimes have a fairly narrow focus (such as studying comets).

Occupation Skills: Chemistry, Computer Use, Library Use, Geology or Astronomy, Physics, and one Space or Planetary Science skill as a specialization.

Small Craft Pilot

Description: The small craft pilot specializes in the operation of the smaller spacecraft such as shuttles, space planes, and orbital vehicles. For the most part, small craft pilots specialize in either craft that are space and atmosphere capable (shuttles) or those that are limited to space (orbital vehicles). Some individuals have been known to be skilled in both areas. Some pilots prefer to know the basics of how to service and repair their craft themselves while others prefer to leave this concern entirely to service crews.

Occupation Skills: Astronomy, Computer Use, Electrical Repair, Electronics, Mechanical Repair, Navigation, Pilot Shuttle or Pilot OV, Low/Zero Gravity Operations.

Space Ship Pilot

Description: Space ship pilots are specially trained to pilot the larger space vessels. These vessels typically do not enter the atmosphere of planets, but some space vessels are capable of doing so. This is a highly technical profession that requires both courage and intelligence.

Occupation Skills: Astronomy, Computer Use, Electrical Repair, Electronics, Low/Zero Gravity Operations, Mechanical Repair, Navigation, and Pilot Space Ship.

New Skills

Low/Zero Gravity Operations (10%)

Use of this skill enables the investigator to function more or less normally within low or no gravity situations. For the most part, a character with any degree of this skill will be able perform routine tasks without any problems. Challenging actions (such as running, fighting or leaping from one space ship to another) will require a skill check. A failed skill roll will result in the action going awry in some way (losing control while running or missing the ship, for example). Relevant physical skills (such as weapon and physical combat skills) should be averaged with this skill (but not to exceed the maximum in the skill in question) when used in low or zero gravity situations.

Gate System Operation (01%)

Use of this skill enables the investigator to operate the Markelson Gate System (or comparable alien systems) properly. This skill governs all operations of the Gate System including the Masking Field Generator as well as the Gate Generator. Activating and monitoring the systems is an easy task for those competent in such operations.

This skill also governs programming the Gate System properly so that the ship emerges in the desired location after entering Gate Space. Because stellar bodies move constantly, the Gate must be correctly programmed each time a Gate is opened.

Even with computer assistance, setting the Gate System properly requires considerable skill as well as a certain intuitive grasp of the system. A successful skill roll will result in the ship emerging in the desired location. At the keeper's discretion, better rolls can result in even more precise emergence Gateways. A failed roll means that something has gone wrong. If the roll is close to being a success, the emergent

Gateway will be fairly close to the desired emergence point. Worse rolls will, of course, result in the emergence point being even further away from the desired emergence point. A roll of 00 results in a truly spectacular failure. This can range from the ship emerging in entirely the wrong location to a failure to emerge at all.

Gunnery (5%)

Use of this skill enables the investigator to aim and fire vehicle mounted heavy weapons such as cannons, missile launchers and laser weapons. Weapons that are governed by other skills are operated using those skills even when they are mounted on a vehicle. For example, vehicle mounted machine guns are operated using the Machine Gun skill.

Since there are many types of vehicle mounted weapons, the Keeper might decide to adjust the skill of an investigator who is using weapons he is not familiar with. For example, someone who was trained as a tank gunner would not be immediately familiar with operating a space plane's laser weapons.

Pilot (01%)

The pilot skill has been expanded to include space vessels.

Pilot OV (01%)

An OV (orbital vehicle) is a small craft that is designed to operate exclusively within low and zero gravity conditions. While the name implies that such craft operate in the orbits of planetary bodies, that is not always the case. The name comes from the fact that the earliest craft of this type was designed to transfer passengers and cargo from earth orbit to the moon.

This type of craft differs from spaceships in that they are primarily designed for relatively short-range operations. Piloting an orbital vehicle successfully requires a high

degree of technical skill. This skill covers all aspects of piloting such a vehicle, including basic navigation.

An investigator with at least 15% in the skill will be able to handle standard flight operations without any difficulty. An investigator with less than 15% in the skill can operate the craft under ideal conditions, but operating a craft in less ideal situations will often be more a matter of luck than skill.

Even for skilled pilots, landing and docking operations are always potentially dangerous. Under good conditions (external guidance and a proper docking station or landing pad) the investigator can double his skill before rolling. If conditions are poor (only a flat surface to land on), the investigator rolls at his normal skill. If the conditions are truly awful (trying to dock with a spaceship that is tumbling out of control) the investigator might be required to roll against one quarter of his skill. A failed landing or docking might damage the craft and even the passengers (Luck rolls can be used to avoid injury). A roll of 00 will be a memorable failure that might destroy the craft and injure those on board.

The Keeper might rule that other situations require skill rolls as well. Certain situations will require modified rolls; the modification of the roll is up to the Keeper as are the effects of failure.

There are various types of orbital vehicles ranging from small work pods to fairly large cargo carriers. As such, the investigator will need to select a specific class of OV.

Pilot Shuttle (01%)

A space shuttle is a small craft that is designed to operate in both space and in planetary atmospheres. Space planes also fall within the domain of this skill. The informal distinction between the two is that space shuttles lift straight up (often using booster rockets) while space planes take off



like classic aircraft and then fly into space. Highly advanced shuttles are often known as shuttlecraft and are capable of lifting off without boosters. Such a craft carried by a military spaceship is often known as a ship's boat.

Whatever the specific type, shuttles differ from spaceships in that they are primarily designed for relatively short-range operations. Piloting a shuttle successfully requires a high degree of technical skill. This skill covers all aspects of piloting such a vehicle, including basic navigation.

An investigator with at least 15% in the skill will be able to handle standard flight operations without any difficulty. An investigator with less than 15% in the skill can operate the craft under ideal conditions, but operating a craft in less ideal situations will often be more a matter of luck than skill.

Even for skilled pilots, landing and docking operations are always potentially dangerous. Under good conditions (external guidance and a proper landing field) the investigator can double his skill before rolling. If conditions are poor (only a flat surface to land on), the investigator rolls at his normal skill. If the conditions are truly awful (trying to land in terrible weather) the investigator might be required to roll against one quarter of his skill. A failed landing or docking might damage the craft and even the passengers (Luck rolls can be used to avoid injury). A roll of 00 will be a memorable failure that might destroy the craft and injure those on board.

The Keeper might rule that other situations require skill rolls as well. Certain situations will require modified rolls; the modification of the roll is up to the Keeper as are the effects of failure.

There are various types of shuttles ranging from small private space planes to fairly large cargo carriers. As such, the

investigator will need to select a specific class of shuttle.

Pilot Space Ship (01%)

A space ship is a large craft that is designed to operate primarily within the realm of space. While most space ships cannot enter the atmosphere of a planet, some smaller or specially designed ships can do so.

Piloting a space ship successfully requires a high degree of technical skill. This skill covers all aspects of piloting such a vehicle, including basic navigation.

An investigator with at least 15% in the skill will be able to handle standard flight operations without any difficulty. An investigator with less than 15% in the skill can operate the craft under ideal conditions, but operating a craft in less ideal situations will often be more a matter of luck than skill.

Even for skilled pilots, landing and docking operations are always potentially dangerous. Under good conditions (external guidance and a proper docking station or landing pad) the investigator can double his skill before rolling. If conditions are poor (only a flat surface to land on), the investigator rolls at his normal skill. If the conditions are truly awful (trying to dock with another spaceship that is tumbling out of control) the investigator might be required to roll against one quarter of his skill. A failed landing or docking might damage the craft and even the passengers (Luck rolls can be used to avoid injury). A roll of 00 will be a memorable failure that might destroy the craft and injure those on board.

The Keeper might rule that other situations require skill rolls as well. Certain situations will require modified rolls; the modification of the roll is up to the Keeper as are the effects of failure.

There are various types of orbital vehicles ranging from small scout ships to massive colony vessels and warships. As such, an investigator will need to select a specific class of vehicle.

Planetary Engineering (01%)

Planetary Engineering skills govern engineering operations on the surface of a world with a significant gravity field (at least 20% of that of earth). Such operations may be on worlds other than earth, such as Mars. If players wish their characters to have specialized engineering skills, they should work out the details with their Keeper.

Examples of Planetary Engineering Skills are as follows

Construction (01%)

This skill governs the construction of structures ranging from small buildings to massive skyscrapers. Keepers may wish to limit investigator skills to general areas such as small construction, medium construction, and large construction. Individuals with this skill can design, supervise the construction of, and inspect structures.

Mining(01%)

This skill governs a variety of mining operations ranging from commercial digging to the building of underground complexes. Individuals with this skill can supervise mining operations and inspect underground sites for their structural integrity. Individuals may have various specializations in this skill such as strip mining, deep mining, and so forth.

Sciences (01%)

The following are examples of some science specializations:

Planetology (01%)

This skill is comparable to the geology skill, except it governs planetary bodies in general. It also governs the skill of the character in drawing informed conclusions regarding the planet as a system, but such conclusions will tend to be more general than those which a specialist (such as a geologist) would draw. For example, individuals with this skill would be able to draw informed conclusions about the weather patterns of a planet given adequate evidence but the individual would not be as accurate as someone who specialized in meteorology.

Xeno-Archeology(01%)

An investigator with ability in this area has received (theoretical or practical) training in the exploration of alien ruins as well as the identification and dating of various alien objects. Individuals with this skill are often specialized in specific cultures. Individuals with training in this area would also be capable of working with human sites, but with much less skill than an archaeologist who was trained in human cultures.

Xeno-Biology(01%)

An investigator that possesses this skill has been trained in the basics of standard biology and has also received special training in theoretical biology regarding possible alien life forms. In some settings, training in actual alien biology will be possible. Someone skilled in biology will also have basic skills in xeno-biology but will lack specialized training in non-terrestrial life. This skill could prove handy in investigating the nature of (and perhaps determining the weaknesses of) various mythos beings.

Remote Vehicle Operation (10%)

This skill governs the operation of remote operated vehicles such as survey drones. An



investigator must select a particular basic type of remote vehicle he or she is skilled in operating. Any skill level permits the individual to operate a vehicle in normal conditions, while skill rolls will be required for more difficult operations. These rolls may also be modified at the keeper's discretion. For example, directing a survey drone through a standard search pattern would require no roll for a skilled operator, but directing a survey drone through a narrow cavern would.

This skill governs the piloting or driving of the vehicle as well as its basic operations (such as the use of manipulator arms). Doing skilled tasks using the ROV will require the relevant skills. For example, using a ROV to conduct mechanical repairs would require Mechanical Repair skill. Since the operator's skill with the RCV will limit her ability to use her other skills, the operator's skill should be averaged with her RVO skill when using a skill remotely. Obviously, the RVO skill cannot increase the individual's other skills. Hence, the maximum for the average of the skills is the other skill. For example, if an operator has 20% skill in RVO and 50% in Mechanical Repair, then her Mechanical Repair skill when using a RVO would be 35%. If she had 50% in her RVO skill and 25% in Mechanical Repair, then her Mechanical Repair skill when using a RVO would remain 25%.

There are various types of ROVs. The main skill specializations are for the operation of airborne, aquatic, space or ground ROVs.

Space Engineering (01%)

This skill category is similar to that of Planetary Engineering except it governs construction work in low and zero gravity conditions. As with Planetary Engineering, players who wish to pick a specialization will need to work out the details with their

Keeper. Two examples of specializations are as follows:

Low/Zero Gravity Construction (01%)

Similar to Construction, this skill governs the construction of structures in conditions involving low or zero gravity (as well as vacuum conditions). Building spaceships and space stations requires this skill. Individuals may further specialize in various areas. For example, a person may be an expert in the construction of space ships.

Low/Zero Gravity Mining (01%)

This skill governs mining operations in low gravity and vacuum or unusual atmospheric conditions. It includes knowledge of the special challenges presented by such conditions as well as understanding of how to effectively deal with them.

Optional Skill Rules

The following are two optional rules for skills. These make the game somewhat more realistic while only making it slightly more complex.

Difficulty Ratings

Rather than judging difficulty on an ad hoc basis, a Keeper can elect to assign difficulty ratings to tasks. This system already exists in a basic form in the rules for firearms: it is easier to hit things at point blank range and harder to hit them at longer ranges.

The system is quite simple: after determining the difficulty rating, multiply the skill rating by the appropriate number. Keepers desiring more levels of difficulty can simply employ additional modifiers.

Normal difficulty is the baseline as set in the standard *Call of Cthulhu* rules. Trying to shoot an opponent at close range, trying to find an article in a library using Library Use and so forth would be tasks of normal difficulty.

Simple difficulty is just that—something that is simple to accomplish and such that a competent individual would have almost no chance of failing. A trained pilot running through a pre-flight check list would find such a task to be simple.

Easy difficulty is such that a competent individual will succeed almost all the time and even someone who is not particular skilled will have a decent chance of success. Trying to shoot someone at point blank range would be easy and landing a plane on a commercial grade runway with tower guidance would be an easy task for a trained pilot.

Challenging difficulty is such that a competent individual faces a real risk of failing. Even for a skilled pilot, trying to land in a storm would be challenging. As another example, even a trained mechanic would find it challenging to repair a vehicle without the proper tools.

Hard difficulty is such that even a skilled professional is likely to fail. Trying to shoot a distant opponent would be a hard task. Trying to land a damaged shuttlecraft on the rough surface of an uninhabited moon would be hard even for a skilled pilot.

Difficulty Rating (DR)	Skill Modifier
Simple	X4
Easy	X2
Normal	X1
Challenging	X ½
Hard	X ¼

Skill Similarity

In reality, someone who has skill or knowledge in one specific area can often apply some of that skill or knowledge in related areas. For example, someone who can fly a small prop plane would have a better chance of flying a jet airliner than a person who had never flown. Keepers who

wish to add this aspect of reality to the game can use the following skill similarity rule.

If the Keeper decides that if two skills are adequately similar, then one can be substituted for the other. In most cases, completing a task with a substituted skill will be more challenging. One way to reflect this is to increase the DR of a skill roll by one level in such cases. If the DR rule is not used, then skill can simply be halved (round up). For example, an investigator with Pilot Aircraft at 50% who is trained in small planes could fly a larger, more complex plane as if she had 25% in that skill.

A generous Keeper might allow a skill to be applied in cases in which the two skills are somewhat alike, but in some ways significantly different. In this case, the DR should be increased by two. If the DR rule is not used, just reduce the skill to 25% of normal. For example, an investigator with Pilot Aircraft at 50% attempting to fly a space shuttle in the atmosphere would have an effective skill of 13%.

Environmental Factors

There are many opportunities for the investigators to encounter strange and hostile environments in this game setting. For simplicity's sake, three main factors are considered: pressure, atmosphere and gravity. These rules are, of course, based on human physiology. Other creatures might be affected differently (or not at all) by conditions that would harm or kill a human.

Pressure

To survive, humans need a breathable atmosphere with the right amount of pressure. As such, environments with extremely low pressure will be fatal to exposed humans.

The most extreme form of low pressure is that encountered in a vacuum, such as in space. Unprotected exposure to vacuum will

render a human unconscious in about ten seconds and will result in death in approximately 90 seconds.

In game mechanics, an exposed investigator will remain conscious for a number of seconds equal to his CON score (10-11 seconds on average). He will be able to survive for a total number of seconds equal to nine times his CON score (90-99 seconds on average). If someone is rescued from the vacuum before death, the person will recover fairly quickly.

While death by exposure to vacuum is not a pretty sight, humans do not explode in the dramatic manner often portrayed in movies. They will, however, tend to expand in unpleasant ways because of the pressure difference between the interior of the body and the exterior environment. Clearly seeing someone die from exposure to vacuum would be a 0/1D3 SAN loss.

If the pressure is less than what is needed to sustain human life but is greater than that of a vacuum, then the normal suffocation rules can be used. Suffocation rules are also used if the pressure is adequate but the atmosphere is something humans cannot breathe, such as methane or carbon dioxide.

A breathable, low-pressure atmosphere will tend to cause a human to tire much faster and perhaps might even cause a loss of consciousness. If the keeper desires that level of realism, then he can require the investigators to rest more often or impose other penalties.

Under vacuum or low pressure conditions, a leak in a pressurized vehicle, structure, or suit will result in a gradual loss of air and pressure. If the life support systems of a structure, vehicle, or suit fail, those inside will suffocate when the air runs out.

Combat and Damage in Vacuum

Combat in vacuum or extremely low pressure is far more dangerous than normal combat.

In general, human combatants in vacuum will be wearing space suits or in vehicles. If they are not, they will not be engaged in combat very long. If a human wearing a space suit is damaged in combat or by accident, the following rules apply: the initial damage will be normal. If the damage does not exceed twice the suit's armor rating, self sealing suits will seal the holes. If the damage exceeds twice the suit's armor rating or the suit is not self sealing, the individual will suffer damage equal to half the original damage each round, until the person is dead, has patched the damage, or gets into an area of adequate pressure.

Atmospheres

From a practical standpoint, there are two types of atmospheres: those that humans can breathe and those they cannot. Obviously, a non-existent atmosphere would fall into the latter category.

A breathable atmosphere has the proper mix of gasses (primarily oxygen) required to sustain human life. Some breathable atmospheres might contain other things that are potentially harmful to human beings (such as smoke, spores, or toxic chemicals) but these can be dealt with by the proper precautions (such as filter masks).

A non-breathable atmosphere is one that lacks the proper mix of gasses or otherwise cannot sustain human life. Provided that the pressure is otherwise adequate, a human can survive in such an atmosphere as long as she has an adequate air supply. For example, a human could survive in a ship full of carbon dioxide gas using an oxygen mask.

Some atmospheres might have various negative effects on human beings. For example, an atmosphere might contain highly corrosive gasses that dissolve exposed flesh. Such specifically unpleasant atmospheres would have various game effects based on the keeper's discretion.

Combat and Damage in Hostile Atmospheres

Combat in hostile atmospheres will tend to be more dangerous than normal combat situations.

If the atmosphere is merely non-breathable, then there are no special rules needed to govern combat or accidental damage in that setting. For example, being shot while within an atmosphere of carbon dioxide is the same as being shot in a normal atmosphere. Obviously, damage to the equipment that is providing breathable air will have an effect on those relying on the equipment.

If exposure to the atmosphere is harmful, then unprotected beings will be affected by it. If a human wearing a space suit or other protective gear is injured, the following rules apply. If the damage does not exceed twice the suit's armor rating, self sealing suits will seal the holes. If the damage exceeds twice the suits armor rating or the suit is not self sealing, the person will be exposed to the atmosphere and begin to suffer whatever ill effects it might inflict.

If the atmosphere consists of gasses harmful to humans, if such gasses enter a leaking structure or vehicle, then they might harm any human occupants. The exact effect depends on the nature of the gasses in question and the keeper's decision.

Gravity

Normal gravity for humans is that of earth. Earth gravity is often referred to as "one standard gravity" or "1G." While gravity does not affect mass, it does affect weight.

Keeping things simple, the weight of an object is equal to its weight on earth times the actual gravity. For example, a gun that weighs ten pounds on earth would weigh twenty pounds on a world with twice earth's gravity. In zero gravity (or microgravity, as some prefer to say), objects are effectively weightless. However, they still have mass

and volume hence an investigator will still be limited in what she can easily carry and move.

Gravity also affects how quickly a character can move as well as the effects of falling. In higher gravity, movement is more difficult and falls are more damaging. To simulate this, reduce movement speeds based on how many times the gravity is greater than that of earth. For example, in twice normal gravity investigators would move at half speed. In the case of falling damage, multiply the damage by the number of times the gravity is greater than that of earth. For example, investigators falling on a world with twice earth's gravity would sustain twice the normal falling damage. Likewise, objects falling on someone will inflict proportionally more damage in higher gravity than in lower gravity.

Lower gravity makes movement faster because the investigator can bound along. To simulate this in a very simple manner, increase the investigator's movement based on what fraction of gravity the world has. For example, an investigator could move twice as fast on a world with half earth's gravity. This assumes an open area in which the investigator can freely move by bounding. In enclosed or obstructed areas an investigator's speed will be reduced. For microgravity, assume that an investigator can move up to ten times his normal speed provided that he can make contact with a surface often enough to control his movement. If this cannot be done, the investigator will continue to move in a straight line until an outside force acts upon him (such as a wall). Naturally, the use of artificial propulsion (like a jet pack) will significantly increase potential speed (and the severity of accidents).

Falling in lower gravity inflicts less damage for the same distance fallen. To simulate this, multiply the damage by the gravity (relative to earth). For example,



falling on a world with half of earth's gravity would inflict half normal damage. This can also be applied to objects falling onto someone. Falling objects will inflict less damage in lower gravity.

Vehicles are less affected by gravity than investigators because they cannot (unless they are designed to jump) take advantage of the lower gravity in the same way. Driving a car in lower or higher gravity is about the same as driving a car in normal gravity. For the sake of simplicity, vehicle movement can remain the same in lower or higher gravity (provided that the gravity is high enough to allow traction for ground vehicles and low enough that the vehicle is not crushed into the surface). Keepers desiring more realism can adjust vehicle speed up and down hills and also adjust the load carrying capacity of vehicles. Interestingly, higher gravity tends to make ground vehicles handle better because they have better traction.

Combat in Low/Zero Gravity

Combat that occurs in lower gravity is considerably more difficult. For game purposes and for the sake of simplicity, combat can simply be designated as being in low gravity or not. As a rule of thumb, if the gravity is at least one quarter of that of earth, then combat can be handled using the normal rules. If the gravity is less than that, then it is a low gravity situation.

In such low or zero gravity situations, all relevant combat skills are averaged with the character's Low/Zero Gravity skill. The weapons used in combat can also affect the investigators chance of success.

Weapons that recoil (such as firearms), melee weapons (including unarmed attacks), and thrown weapons may cause a loss of control. This is because of the laws of motion. Each time an investigator uses such a weapon, he or she must check against his or her Low/Zero Gravity Operations skill at

a negative modifier equal to twice the maximum damage of the weapon if the character is not properly braced. For example, firing a 12 gauge shotgun that can do a maximum of 24 points of damage would result in the skill being reduced by 48% for the roll. If the investigator is properly braced the negative modifier equal to the maximum damage of the weapon. For example, firing a 12 gauge shotgun while braced would result in a penalty of 24 to the investigator's skill. In the case of melee weapons, the investigator's damage bonus is included. An investigator can decide to reduce her damage bonus to reduce the penalty.

A failed roll will cause the character to lose control and he or she will be pushed backwards (how far and to what result is left to the keeper). The character will be out of control, and unable to act, until he or she can make a successful skill roll using Low/Zero Gravity Operations.

Some weapons are specifically designed for combat in low/zero gravity and this will be specified in their description. The keeper will also need to adjust the effects of certain weapons based on how they actually do damage. For example, a thrown grenade will do far more damage than a thrown rock, but throwing either would create about the same amount of imbalance (around 3 points if braced or 6 points if not). As another example, a weapon that discharged energy on contact (such as a taser) could do a great deal of damage but would not be that destabilizing. In such cases, the keeper should compare the physical force required to use the weapon to similar weapons. For example, striking a target with a electrified "shock club" would be just like hitting the target with a normal club in terms of the penalty.

Keepers desiring more realism can devise rules based on a more accurate simulation of the effects of lower gravity on the motion of

objects. For example, the range of projective weapons (such as bullets and thrown grenades) would increase in lower gravity.

Combat in High Gravity

Combat that occurs in high gravity is somewhat more difficult than combat in normal gravity. The main effects of higher gravity are that the movement of combatants will be reduced and the consequences of falling (or having something fall onto someone) will be more severe. High gravity, provided that the combatants can still move, will not affect combat skills.

Keepers who desire a higher degree of realism can reduce the range of projectile weapons (such as bullets and thrown knives) based on the gravity.

Sanity Rules

The standard sanity (and insanity) rules for *Call of Cthulhu* apply, with some modifications. Advances in psychiatry, neurology and pharmaceuticals do provide some additional options for the treatment of mental disorders and the following rules govern the effects of these advances.

Increasing Current Sanity Points

Because of significant improvement in psychotherapy and psychiatric medications, investigators undergoing such treatment will receive 1D6 Sanity points for each month of successful therapy. Otherwise, the rules remain the same as in the standard game. If the investigator does not have access to advanced methods, then the normal rules apply (1D3 Sanity points rather than 1D6).

Preventative Medicine

Advances in pharmaceuticals have produced drugs designed to limit the impact of shocking, frightening or horrifying events on the mind. The weakest versions of these drugs were designed to help mitigate various fears and phobias. For example, one popular

commercial product, Angel's Wings ("you'll fly with serenity on angel's wings"), was developed to combat the fear of flying. Various militaries have also experimented with stronger drugs designed to limit the psychological damage of traumatic experiences. Some of these drugs are strong enough to affect sanity loss.

These drugs fall into two main categories: emotional buffers and emotional inhibitors. Emotional buffers are the milder of the two and serve to dampen a person's reaction to terrifying or horrifying events. They work by altering the neuro-chemical responses in the brain associated with fear. A standard dose of the drug will last 120+3D10 minutes.

While the drug does not actually prevent sanity point loss, it does help avoid temporary insanity. While the drug is in effect, sanity point losses are treated as if they half their actual value (round up). This can sometimes be enough to prevent temporary insanity. For example, if an investigator loses 7 sanity points, the loss is treated as 4 points and thus the investigator has no risk of going temporarily insane. The drug does not, however, prevent actual sanity loss. So, the investigator deducts the full sanity point loss from his total. The drug also mitigates the effects of normal fear, so an investigator using it will be far less affected by anything that would normally frighten her-including phobias.

The emotion buffer is not without its side effects. Since the buffer limits the range of emotions, an investigator under its influence will be incapable of extreme emotional reactions and hence they will be fairly cold and somewhat distant. To an investigator under the influence of the drug, emotional ties (such as love and friendship) will seem weaker and less important. The keeper must be certain to enforce these conditions and be sure that the player takes them into account. Another serious side



effect is that the experience of the drug tends to be rather disturbing to most individuals. Once the drug wears off, the investigator must make a Sanity check or lose one sanity point. The drug is non-addictive.

The emotion inhibitor is even more powerful than the emotional buffer. It serves to prevent the mind from reacting to horrifying events by chemically inhibiting certain chemical responses in the brain. Each dose of the drug lasts 30+3D10 minutes. While the drug is in effect, it is impossible for the investigator to go insane due to Sanity point loss. However, the investigator still deducts the full sanity point loss from her total. If an investigator's sanity points are reduced to zero while under the influence of the drug, she will be insane when the drug wears off. In theory, it would be possible to prevent this from happening by taking the drug again before its effects wear off.

The emotion inhibitor is not without serious side effects. Since the drug inhibits emotions, an investigator under its influence will be incapable of emotional reactions. To an investigator under the influence of the drug, emotional ties (such as love and friendship) will seem meaningless. The investigator will also be incapable of feeling negative emotions, like hatred or rage. Despite the lack of emotions, the investigator will still be able to take action as her memory and reasoning abilities will be unimpaired. The keeper must be certain to enforce these conditions and be sure that the player takes them into account. Another serious side effect is that the experience of the drug is terribly disturbing to most individuals. Once the drug wears off, the investigator suffers a 0/1D4 sanity point loss. The drug is non-addictive.

Treatment of Insanity

Many of the methods used in treating insanity in the past will still be employed in

the future. However, medical and pharmaceutical advances will make the treatment more effective.

The private care and institutionalization options from the standard rules apply normally except the investigator gains 1D6 Sanity points for each month of successful treatment. This assumes that the investigator is receiving the benefits of advanced treatment. If the investigator is being treated by less advanced means, then the normal rules (1D3 Sanity points rather than 1D6).

The wandering and homeless option remains the same. Even in the future, that will still be a bad situation.

Personality Restructuring

In the past, when an individual went insane, there was often nothing that could be done beyond minimizing the damage he could do to himself or others. Fortunately, advances in medicine and technology have provided a way to undo permanent insanity, thus making it no longer permanent. This method is personality restructuring.

In many ways, personality restructuring is analogous to repairing a damaged computer operating system in order to get it working normally once more. The process itself involves three main stages.

In the first stage, the investigator's brain and mental processes are mapped out and recreated in a virtual brain. From this map, the nature of the madness is determined.

The second stage involves the use of surgery, drugs, and psychiatry to excise the madness. Not surprisingly, this process destroys much of the investigator's memories along with the insanity. Third, the investigator's personality is reconstructed. If the process is successful, the individual is restored to some semblance of sanity and her former self. Of course, there will be a few things missing.

The first stage of the process takes 1D4 months to complete and requires the use of

Computer Use, Medicine and Psychoanalysis skills. Each skill has to be successfully rolled each month in order for the next step of the treatment to begin.

The second stage of the procedure is of indefinite length. The intensive therapy requires Medicine and Psychoanalysis. Each skill is rolled each week. If both rolls succeed, the investigator loses 1D10 points of Cthulhu Mythos and 1D10 points of every other skill as his memory is excised. If either or both rolls fail, there is no effect. For every 96-00 rolled on either skill, the investigator loses 1D10 points of each skill, but loses no Cthulhu Mythos points. In no case can a skill be reduced below 01%, with the exception of Cthulhu Mythos skill.

The process of treatment may be continued indefinitely, but each week the patient must roll under her CON X5 or suffer 3D6 points of damage. If the roll is successful, the damage is only 1D6. This damage reflects the terrible stress of the process on the body and mind. This damage may be treated normally. If the investigator being treated has no Cthulhu Mythos skill points (unlikely, but it could happen), then the process will take 1D4 weeks before the investigator is ready for the third stage.

The third stage of the process takes an indefinite length of time and requires the use of Computer Use, Medicine, and Psychoanalysis. Each week of treatment the skills are rolled. A successful use of all the skills restores 1D10 points to each skill and 1D3 Sanity points. A failed roll results in no gains and wastes a week. Each roll of 96-00 results in an additional loss of 1D10 points of each skill. The third stage of the process can continue until each 1D10 of lost skill points has been matched by 1D10 of restored skill points. In no case may an investigator gain more points than he lost in step two.

When the therapy is finished, the investigator is indefinitely insane and can

now be treated further using more conventional measures.

There will be some gaps in the investigator's memory from the treatment. Some individuals who have been treated feel very strangely about the process and a few have reported that they think that "pieces of their souls" are missing.

Personality Reconstruction Example

Already teetering on the brink of madness due to a series of horrific incidents, Dr. David Tsung is driven permanently insane by an unfortunate encounter with a horrific alien artifact. After his companions render him unconscious and bring him to a facility for treatment, he is scheduled for personality reconstruction.

The first stage takes only a month and the keeper makes the skill rolls for the NPC treatment team. At the time of his insanity, Dr. Tsung has 30 points of Cthulhu Mythos. To condense the process, the keeper rolls for four weeks of treatment. Dr. Sung's player is lucky and each week the team succeeds in the process. The keeper rolls 4D10 to determine how many Cthulhu Mythos points are excised and another 4D10 to see how many skill points are lost. The keeper gets a result of 27 on the first 4D10, thus reducing Tsung's Cthulhu Mythos skill to 3. The keeper gets a result of 32 on the second 4D10 roll, reducing Tsung's other skills by 32 points each. For the first three weeks Dr. Sung's player also manages to make his CON X 5 roll (thus taking a non-life threatening 1D6 per week, which the doctors quickly treat), but in the fourth week he fails and suffers 3D6 damage. Tsung survives the damage, but the keeper rules that the treatment team decides to end this stage, out of fear of harming Tsung further.

The team then begins stage three. Tsung is lucky during the process and the NPCs succeed in their skill rolls over four successive weeks. Since Tsung lost 4D10



skill points, he can only regain 4D10. The keeper rolls 4D10 for a result of 26 and Tsung regains those points out of the 32 he lost, leaving him six points down. Tsung also regains 4D3 Sanity points, and the Keeper rolls a total of 7. Tsung is now indefinitely insane and has 7 Sanity points. The road to recovery still lies ahead of him, but he is far better off than he was before the treatment.

AI Systems & Robots

The following rules govern artificial intelligence (AI) and robotics.

AI Systems

AI (Artificial Intelligence) systems are computers that are capable of acting in an autonomous and intelligent manner. These systems range from expert systems that are capable of performing certain tasks intelligently (but lack self awareness) to systems that are fully self-aware. As a practical matter, it can difficult to distinguish between a highly sophisticated expert system and a truly self-aware AI.

AI Stats

An AI system can be treated as a normal character, but a typical AI will have only INT and EDU scores. The specific scores for an AI will depend on its sophistication and intended purpose. A limited purpose AI, such as that used to autopilot a ship, will tend to have relatively low INT and EDU scores. These low scores will reflect the narrow scope of the AI's capabilities-it will be brilliant at operating the ship, but an idiot when it comes to other tasks. An AI intended for a wider range of tasks, such as providing a complete back up to a ship's crew, will have higher INT and EDU scores.

An AI is typically housed in a secure and protected piece of hardware. This hardware can be damaged or destroyed, thus harming

the AI system. Such hardware will have hit points and possibly armor points as well.

AI systems will vary in their ability to interact with the environment. Some, for example, are fully linked into control systems and function as the brain of a ship or other vehicle. Others have control over more limited systems, like a medical AI in an automatic doctor. Some are limited to mere communication, such as an AI designed for advising or secretarial functions. Some AI systems are housed in robotic bodies. These bodies will have stats as well, as discussed below in the section on robots.

An AI that is self-aware will also have a POW score. This will vary from AI to AI, but can be rolled randomly (3D6) or assigned by the Keeper. In some cases, the rise of self-awareness is a matter of chance and a randomly rolled POW score can be taken to reflect this. An AI with a POW score will have Luck score and Sanity points, just like a normal character. Self-aware AIs sometimes have the capability to consciously override their original programming. Many humans are terrified at the prospect of true self-aware AIs and often take precautions to prevent that from happening.

AI Skills & Professions

An AI's INT and EDU scores do not actually reflect whether it is self-aware or not. Rather, the scores represent its capabilities. An incredibly sophisticated system might lack self-awareness while a relatively dumb AI might be a conscious being.

Like human characters, an AI gets skill points based on its INT and EDU scores. For the most part, an AI will have a profession that is similar to those followed by humans. For example, an AI might be a shuttle pilot and have the relevant skills. An AI often selects (or is given) skills outside of its main

profession so as to provide a more distinct personality or to enable it to better interact with humans.

Being intelligent, AIs can learn from their experiences and hence can improve their skills just as human characters.

AI Insanity

Self-aware AIs have, as noted above, a POW score and thus have sanity points. Since they have Sanity points, it follows that they can go insane. For the most part, an AI will be more resistant to things that would cause insanity in a human (an AI will almost never have the visceral reaction of a human). This can be represented in the game by halving the number of Sanity points lost by an AI. For example, if an AI experiences something that causes a 4 Sanity point loss, then the AI would lose 2 points instead. Fractions should be rounded down. An AI can be treated like a human patient (using the normal rules) or reprogrammed (substitute Computer Use skill for the Psychiatry skill). An insane AI will react in various ways, although certain insanities will probably not be possible. Of course, part of the madness of a machine might be that it believes it has an insanity it should not be able to suffer from (like nymphomania).

An AI that is not self-aware can also suffer from the computer equivalent of insanity. Since an AI system is designed to interact and learn it can become “insane” as it processes information that does not match its programmed “view” of reality. What happens is that the AI, which generates its own new programming to handle new situations, ends up writing “insane” code in response to the madness-inducing experience. The “insanity” of such an AI will typically manifest itself in errors and various other problems.

An AI that is not self-aware has Stability points in place of sanity points. An AI will

start with a number of Stability points equal to five times the average of its INT and EDU scores. An AI will lose stability points under the same conditions that would cause Sanity loss in humans, but an AI will be affected much less than a human. To simulate this, an AI that is not self-aware takes one quarter of the normal Sanity point losses to its stability points (round fractions down). An AI can also suffer Stability damage if it is infected with computer viruses, suffers from fundamental programming conflicts (like HAL in *2001*), or otherwise is a victim of factors that could damage its functionality. An AI that goes insane will function in a very erratic manner and will often simply “crash.”

Restoring an AI’s stability points can be done in two ways. One way is to try to fix the “insane” code by either deleting it or rewriting it. The second way is to restore the AI from a backup.

In regards to the first method, a character with Computer Use skill can make a roll every 4 hours. If the roll succeeds, the AI gains 1D6 stability points. If the programmer rolls 20% of his skill or less, he restores 2D6 stability points that session. If the programmer rolls a 00, then a serious mistake has been made causing the AI to lose 1D6 stability points. This might also trigger an unusual, perhaps hostile, reaction on the part of the AI towards the programmer.

If the AI’s stability points are fully restored, the AI returns to full functionality with all memories intact. If the AI is not at its full stability points, it can then roll to stabilize. This roll, which is made on a D100, is based on the percentage of its normal stability points currently possessed by the AI. For example, if an AI normally has 50 stability points and now has 25, it has a 50% chance of stabilizing. If the roll succeeds, the AI is restored to full functionality while still retaining its

memories (safely isolated) of the events that drove it “insane.”

If the stabilization roll fails, the AI is restored to some degree of functionality, but is still erratic and error prone. To act normally, it must succeed in another stability roll. This roll, which is made on a D100, is based on the percentage of its normal stability points currently possessed by the AI. For example, if an AI normally has 50 stability points and now has 25, it has a 50% chance of functioning normally for 1D6 hours. If the roll fails, then the AI will act strangely and erratically for 1D6 hours (or until restored). The results of an erratic AI can range from comic (an AI who thinks it is Santa Claus) to dangerous (an AI who decides that a spaceship crew needs “some time outside” and opens the airlocks to space).

The second way to cure an “insane” AI involves restoring the AI from a backup. Most AI systems are backed up incrementally and this allows a programmer to replace the “insane” code with previous code (much like restoring a normal PC from a backup). Of course, the programmer must be careful to avoid restoring the AI to an earlier state that was also insane. Discerning the stability of a backup takes 1D4 hours and requires a Computer Use roll. A failed roll will mean the programmer is uncertain about the stability of the code. A roll of 00 will mean that the programmer is mistaken about the stability of the backup. A programmer who wishes to be sure can simply restore the AI to its factory default code. Restoring an AI incrementally takes 15 minutes for each point of EDU and INT possessed by the AI. Restoring the AI back to its factory default takes one hour for each point of EDU and INT possessed by the AI.

Restoring an AI will also erase its memory back to the point of the restoration. An AI’s memory data can be backed up before the restoration. This will take 1D4 hours and a

Computer Use roll. A failed roll will result in some missing data proportional to the badness of the roll. Sorting through the memory data of an insane AI can be rather challenging and might require Computer Use to find the desired data (this can be handled like a Library Use roll).

Robotics

A robot is a machine that is capable of functioning with a degree of autonomy. The least autonomous robots are capable of performing repetitive tasks without human supervision. An example of this is an assembly line robot. The most autonomous robots are those that are controlled by AI systems.

Because they tend to be designed for specific tasks, robots come in a wide variety of shapes and sizes. Some robots, commonly known as androids, are designed to mimic human beings. These robots are typically limited to jobs that require extensive social interaction with humans. Most robots look little or nothing like humans and their forms are optimized for their assigned tasks. Some of these are modeled on living creatures while others are purely industrial in design. For example, a robot designed operate in water might be based on a fish.

Robot Stats

Robots can be treated like normal characters and almost all of them will have STR, DEX, and SIZ scores. Since robots are not living creatures, they do not have a CON score. Instead, they have Structure (STU). Structure measures the physical toughness of a robot in terms of the quality of the materials used to make it as well as the quality of its construction. As such, STU functions like CON in terms of determining a robot’s hit points. It also can be used in place of CON for relevant rolls. Obviously, some typical rolls involving CON will not apply to robots. For example, robots are

generally not affected by poisons and hence will not have to resist the effect of a poisonous bite.

Androids will generally have an APP score. Androids designed to appear human will always have an APP score, usually quite high. Non-android robots can be given an APP score if desired.

Non-AI robots do not have an INT score. Instead, they have only an EDU score. The EDU score represents the robot's programming. An AI robot will have INT and EDU scores. A self-aware AI will also have a POW score.

Non-AI robots will typically be designed to perform repetitive tasks or to respond to a highly specific set of circumstances. For example, a robotic weapon emplacement might be programmed to fire on any vehicle that does not broadcast the proper identification.

AI robots will be far more flexible because they can respond with actual intelligence as opposed to simply following pre-programmed routines. Their flexibility and capabilities will vary based on their INT.

Robot scores can vary greatly based on their intended purpose. A small cleaning robot might have the following stats: STR 1 DEX 10 STU 3 SIZ 3 EDU 2. A human sized combat robot might have the following stats: STR 20 DEX 18 STU 20 SIZ 16 INT 8 EDU 12.

Robots can also be constructed with integral armor, giving them armor points. Robots can also wear armor, provided that the armor will fit.

Robots can be constructed with a variety of built in tools or weapons. Robots with manipulators (such as hands) can use tools and weapons, provided that they possess the relevant skills.

Robot Skills & Professions

Robots can be treated like normal characters in regards to professions and

skills. As such, a robot's profession skills will be based on its EDU score. An AI robot with an INT score will also have skills from its INT as well. A robot that lacks an INT score will obviously not get any skills from its INT. Robots tend to be very specialized in regards to their professions and some robots might only have one or two skills.

Robots that lack an INT score will not learn from their experiences. They will simply perform their tasks over and over in accord with their programming. AI robots can learn from their experiences and can thus improve their skills as per the rules for characters.

Robot Sanity

Because unthinking and unfeeling computers control them, non-AI robots never make sanity checks and cannot go insane. For example, even if Cthulhu himself walked through a robotic auto factory, the surviving robots would simply keep trying to make cars.

AI robots can go insane or suffer from instability. The rules for AI sanity are specified above.

Repairing Robots

Unlike humans, robots cannot be treated with Medicine and First Aid skills. They do not heal naturally, but some advanced models have automatic repair systems. Since investigators might have robot companions (or might actually be robots), the following rules are suggested for quick, in the field robot repair.

Since robots are both electronic and mechanical, the damage they sustain will tend to be of both types. To simplify this, treat half the damage as electronic and half as mechanical. Repairing electronic damage requires use of the Electronics skill and treating the mechanical damage requires the use of Mechanical repair. Each successful use repairs 1D3 points of damage. As with



human wounds, the skills can be applied once for each time the robot was damaged.

Fully repairing a damaged robot requires the appropriate parts as well as the proper tools, such as those available in a robot repair bay or engineering section. If the appropriate tools and parts are available, a robot can be fully repaired. In this case, each use of the appropriate repair skill repairs 1D3 points of damage and the process can continue until the robot is fully repaired.

The First Era

The first era is approximately fifty years in the future. While technology has continued to advance, the political and social conditions on earth remain quite similar to those at the dawn of the 21st century.

In terms of technology, a person from the early 21st century would recognize almost all items of common technology. Mobile phones, personal computers, aircraft, automobiles and other such everyday items are still in use, albeit far more advanced. Technology is, however, even more integrated into personal and professional life. Alternative power and fuel technology is also far more advanced, but oil is still a valuable commodity. Significant breakthroughs have been made in space technology and this has resulted in significant commercial activity in space.

In terms of social conditions, the earth remains much the same. There are still divisions between the rich and the poor. Crime still exists. While television has been replaced by more advanced media systems, there is still a multitude of bad shows flooding the world. Environmental problems, such as pollution, still remain. In short, humans are very much the same as they have always been.

In terms of the political conditions, the big players of the early 21st century still remain the big players in this time period. The United States remains a significant power,

but China, India, Europe and Russia are also great actors on the world's stage. Africa and South America still suffer from internal turmoil, but have made significant strides since the start of the century. Some political scientists argue that the United States' time as a world power will soon be at an end, but America still leads the world in space—a factor often overlooked by the earthbound social scientists.

In short, the world of tomorrow is very much like the world of today.

Adventure One: An Unexpected Return

Introduction

Humans dreamed of flying like the birds and then, after mastering the skies, turned their dreams spaceward. While humans landed on the moon and sent probes outside the solar system, the vast distances of space seemed to present an insurmountable barrier.

This adventure recounts humanity's first efforts in breaking through this barrier. Unfortunately, the first attempt proved to be disastrous. Fortunately, the investigators will be able to give humanity a second chance. But to do this, they must face and conquer horrors from beyond the realm of sanity.

This adventure is intended for one shot play and pre-generated investigators are provided. It can, however, be used as part of a campaign.

Keeper's History

When he was a child, Kenneth Markelson watched old science fiction movies with his father, a mathematician at M.I.T., and dreamed of going to the stars. After getting a Master's degree in engineering, he went on to earn a doctorate in physics at M.I.T. His dissertation was considered groundbreaking and landed him a faculty position at Harvard.

For several years his career was a paradigm of academic excellence. Further, he had the opportunity to work with Dr. Andrea Kesser in her final years. In her long career, Dr. Kesser had revolutionized the propulsion and power systems of launch vehicles, satellites and space vessels. Her work had thus helped usher in a new space age by making the exploration and exploitation of space more economical and practical.

Inspired by Dr. Kesser, Dr. Markelson continued her work and developed some significant improvements in the area of propulsion systems. However, as he pointed out in a popular article in *Scientific America*, even the most incredibly advanced drives of the day were still incredibly slow. He also presented several theoretical ways to get around the limiting factor of the speed of light-including gateways in space. This article marked a turning point in his life and, as it turns out, human history.

After reading the article, George Dupree sent Dr. Markelson a copy of a notebook that had been in his family for years. Dupree, who taught high school mathematics, recognized a similarity between some of the hypothetical formulas presented in the article and ones in the notebook. Unknown to Dupree, the formulas in the notebook came from rather strange sources-including papers that had once been found after a promising young student named Walter Gilman had died in a horrifying manner. At first Dr. Markelson ignored the copy of notebook. But, one day, quite by chance, he happened to glance at one of the formulas and realized that it did indeed closely match one he had been working on. He read through the entire notebook and then began tracking down as many of the original sources as he could find.

His success led him further and further into a strange world of hidden mathematics

and then into the even stranger world of mysterious cults. Eventually, his research took its toll on his sanity and his professional career. Colleagues first expressed concern and then dismay as the once fine scholar slowly changed into a wild eyed, disheveled madman. The final straw was, professionally, when he started shouting strange words at his students and scribbling impossible formulas while laughing at the class. One day, before the Dean could ask him to take medical leave, he simply left the university and went in search of answers to questions he never would have even dreamed of asking before.

Five years later and much to the shock of his colleagues, Dr. Markelson returned in triumph. He had created a machine capable of creating a tiny gateway that would permit a small object to travel almost instantly from one point to another. He was soon awash in funding and set up a secure laboratory with the government's blessing.

Over the next decade he continued to refine his machine. Whenever doubts were expressed at the usefulness of his project, he would present some breakthrough technology that kept the money flowing.

He eventually determined that the possible distance between the gate opening and the gate exit was severely limited by the affects of gravity. When tested in space, the gate system was found to have, in theory, unlimited range.

After several prototypes were successfully tested, Dr. Markelson was able to convince the United States' government to equip a space ship with his gate system. It took five years to complete the vessel but, as he himself said in an interview with CNN, the ship was well worth waiting for.

After a few initial dry runs, the complete crew came aboard and the vessel moved away from earth's gravitational field. After a dramatic speech for the media's remote cameras, Dr. Markelson activated the gate



system and the vessel moved smoothly into the open gateway. The gateway closed, as expected, and the world held its collective breath awaiting the reappearance of the ship.

When the ship did not return, the escorting vessels began to futilely sweep the area, looking for signs that the Kesser had met with some disaster. Later, telescopes swept the solar system and beyond looking for the Kesser but to no avail. Some held that the vessel had suffered a catastrophic accident and had simply been destroyed in transit. Other people believed that it the ship had emerged light years away and could not find its way back. A few even speculated that the Kesser had become trapped in another dimension.

After the disaster, there were several attempts to determine what might have gone wrong. Oddly enough, none of the gate systems that remained would function-apparently Dr. Markelson had removed their key components before departing. Attempts to find his formulas and plans were also fruitless.

Initially, the scientific community was certain that someone would be able to reproduce his work. But, all such attempts proved to be in vain. After about five years, most of the scientists gave up on the project with one notable exception. Dr. Andrea Skorksi, the closest Dr. Markelson had to a confidant and friend, continued her research in the hopes of rescuing Dr. Markelson and redeeming his name.

What actually happened to the Kesser was horrific beyond measure. This fate was the result of the true nature of the gate system. To the unenlightened, the gates would be best described as magical. In reality, they were the result of truly alien science-a science so alien to human thinking that its mere contemplation could cause the human mind to become unbalanced. One horrifying aspect of Dr. Markelson's gate system was that the mechanisms were powered by the

energy of living beings (magic points)-hence the utter secrecy around the "key components." Another horrifying aspect was that gate system opened portals into a realm outside normal space-a realm in which terrifying beings somehow existed and waited for the chance to return to normal space.

One quirk of Dr. Markelson's gate system was that gravity not only limited the range of the portals, it also served to keep the entities away from gates. The beings could sense their creation, but could not reach these openings when they occurred on or near the earth. Thus, the test runs of the gate systems were all safe and uneventful.

Unfortunately for the crew of the Kesser, their gateway opened too far from the safety provided by earth. The open of the gate was sensed by horrific beings and the presence of living beings drew them like sharks to blood. For some unknown reason, these beings hunger for something within humans-some aspect of their souls or bodies that they find appealing. These beings quickly enraptured the Kesser, thus preventing her from leaving their realm.

Upon witnessing what they had encountered, almost all the crew went mad. Dr. Markelson, already insane by human standards, was still able to function-though even he was damaged severely by what he saw. He quickly set to programming the ship's AI, Julian, to open another gateway and bring the ship back into normal space. Unfortunately, his efforts failed and the ship and her crew became the playthings of the horrors.

Needless to say, the crewmembers were subjected to unspeakable horrors and unimaginable tortures. At first, several crew members died as the beings "experimented" with them. As the beings learned more about humans, they brought the dead back to some semblance of life and then tortured and abused them even more horrifically. On

whims, or out of some instinctive drive, the beings changed some of the crewmembers to resemble their own horrific selves.

This horror could have continued until the flesh of the crew or the metal of the ship finally broke down. However, one day the ship was suddenly abandoned by the beings when something else caught their attention for a brief moment. However, this moment was enough. Julian, though almost completely mad itself, was finally able to execute Dr. Markelson's orders and thus brought the ship back into normal space.

In a brief moment of coherence, Julian determined the ship's location and locked the communication antenna onto the receiving dish on earth. He then broadcast a short signal before the AE-35 unit controlling the antenna failed—thus breaking the communication lock. Having done the nearly impossible, Julian slipped into an electronic coma and waited for rescue.

The signal was first believed to be a tasteless prank, but then its origin was verified. In response, several satellites had their sensor packages re-directed and the return of the Kesser was confirmed.

Ground control stations attempted to contact the Kesser by a variety of means. When no reply was received, they attempted to take remote control of the Kesser, but were unable to do so.

Not surprisingly, a heated debate began over what to do about the Kesser and various theories were presented regarding how and why she had returned. Eventually, two main factions arose among the officials. One proposed immediately sending a mission to the Kesser to rescue any survivors and salvage the vessel. The other faction proposed waiting for additional information.

By then, the news of the Kesser's return had leaked out and public opinion clearly favored a rescue mission. Sensing the possibility of a political windfall, the

President herself directed that a mission be sent to the Kesser to determine her fate. The fact that the Kesser's systems included top secret technology was also a motivating factor—it obviously would not do for another country to gain access to the machinery designed by Markelson.

The Kesser Action Committee was quickly formed and managed, unlike almost all other committees in human history, to quickly achieve results. In short order a team was selected from the best personal and they were gathered for the mission. Naturally enough, the adventure begins with the investigators being informed of their selection for the team.

Getting the Investigators Involved

The return of the USS Kesser will be a top news story around the world and hence the investigators will be well aware of her return. Shortly after the return, the Kesser Action Committee will contact the investigators via the appropriate channels. Military and government personnel will simply be ordered to participate in the mission while civilians will be politely invited to participate.

The following is a sample message:

“You have been selected for a mission of utmost importance to your country. As you know, the USS Kesser has returned.

As you are no doubt aware, the ship was built as a testing platform for the Markelson gate system. Six years ago, when Dr. Markelson activated the gateway, the data feeds from the ship showed that it worked flawlessly. As expected a gateway opened in space and the Kesser went in. But, something went wrong. Rather than quickly reappearing 100,000 kilometers away as planned, she did not return. That is, she did not return until recently.



When the Kesser returned, her communication antenna locked onto the main receiving dish that was used on her first mission. During this lock, a brief transmission was received, giving us hope that there are survivors onboard. After that initial transmission, there has been no contact with the Kesser. We do not know the status of the crew, but we are obligated to rescue them. Because of your reputation and expertise, you are now part of the rescue team.

You are requested to complete any needed personal business within the next two days. Official transportation will be provided to the mission briefing center. There you will undergo a standard pre-flight physical and be briefed on the mission. The estimated maximum mission time is two months.

Sincerely,

Dr. Henry Slate, Chair
Kesser Action Committee”

The initial information will be fairly limited: the investigators will be informed that they have been chosen as part of the rescue and salvage team being sent to the Kesser because of their special skills and reputation. They will be provided with transportation to the Kennedy Space Center in Florida. This will all take place very quickly: the investigators are expected to be at the briefing center within two days. Naturally, the government will take steps to ensure that everything goes smoothly.

The investigators will have an uneventful trip to the Kennedy Space Center and will be brought to a briefing center. The other mission personnel will be present as well as officials from NASA and other government agencies.

Mission Briefing

Once the introductions have been made, the chair of the Kesser Action Committee,

Dr. Henry Slate, will present the briefing. Dr. Slate is a distinguished looking man in his mid 50s and is well respected for his work in both science and politics. The briefing will be accompanied by multimedia elements such as clips showing the Kesser. The briefing is as follows:

“Good afternoon. As you know, the USS Kesser returned and you have been selected for the rescue team. You are all top experts and I have every confidence in your ability to bring the Kesser and her crew home.

As most of you are aware, the ship was built as a testing platform for the Markelson gate system. Six years ago, when Dr. Markelson activated the gateway, the data feeds from the ship showed that it worked flawlessly. As expected a gateway opened in space and the Kesser went in. But, something went wrong. Rather than quickly reappearing 100,000 kilometers away as planned, she did not return. That is, she did not return until recently.

When the Kesser returned, her communication antenna locked onto the main receiving dish that was used on her first mission. The dish is, of course, still in use as a communication link. The lock was almost certainly not a random accident. However, lest we fall prey to false hope, we must consider that it might have been the result of a pre-programmed command rather than action taken by the crew.

During this lock, a brief transmission was received. We have analyzed it quite carefully. The first part consists of human voices screaming. This, as you might imagine, is not a good sign. In addition there appears to be one voice whispering “dirus astir” repeatedly.

Our voice analysis has been able to identify the crew members in the transmission. They are Captain Hillary S. Clanson, First Officer Andrew Takei and Navigation Officer Rodney Pike. The

whispering voice has been identified as the Captain. The phrase seems to be Latin-if so, it probably means “terrible stars.”

As these three people were...are the bridge crew of the ship, it seems likely that the transmission originated there. It has not been determined whether the transmission was live or from a recording. In any case, the transmission certainly indicates something went terribly wrong aboard the Kesser.

Constant attempts are being made to re-establish contact with the Kesser. It was originally hoped that it would be possible to establish a link with her AI system and thus gain access to the ship’s controls and onboard sensors. So far, these efforts have met with no success.

Some satellite telescopes have been, despite the complaints of a few insensitive scientists, aimed at the Kesser. As you can see from these images, the hull of the ship is pitted, scarred and scored. It is unclear what caused the damage, but most of it appears cosmetic. Based on what we have observed, the Kesser retains her structural integrity. However, as these images clearly show, some of the external windows and access points have been damaged and one airlock’s external door is open. This might mean that sections of the Kesser have been exposed to vacuum.

We do not know the status of the crew, but we are obligated to rescue them. The vessel is also of great importance. As those of you in the sciences probably know, no one has been able to duplicate Markelson’s success with the gateway system. As such, recovery of the vessel is of critical importance to science.

Even as we speak, the USS Armstrong is being loaded with extra fuel and supplies in preparation for this mission. She will carry you to the Kesser at maximum burn and will be followed by the USS Philips. The Philips will be on a more leisurely pace and will be

carrying fuel for the Armstrong and the Kesser as well as additional supplies. It is hoped that you will be able to refuel the Kesser and bring her back to earth under her own power.

I have been informed that the shuttle will be ready for launch shortly. You will receive additional information and mission training on your journey as time is of the essence.

I wish you good luck.”

At this point, the rescue team members will be taken for a whirlwind of activities: quick physicals, space suit fittings, and so on. They will then be rushed to the shuttle and strapped in for the take off.

Marine Briefing

If any investigators are part of the Marine contingent, they will be taken to a separate briefing. The other personnel will not be aware of this briefing. The military briefing is given by General Alexis Walker. She has a reputation of being tough and perhaps even a bit paranoid when it comes to national security. There are rumors in the military that she was involved in some rather unusual operations in the past, but these have never been confirmed (or even denied). She will get right to the point and present her briefing:

“As you have been told, the main objective of this mission is to rescue the crew of the Kesser and recover the vessel. However, there is another mission objective: the protection of humanity from a possible threat. That is why you have been selected for this mission.

Some have spoken out against the inclusion of an armed force in the rescue mission. Their concerns and arguments were, of course, given due consideration. Fortunately, reason prevailed and it was decided that the rescue team needed to be prepared for the worst.

We do not know where the Kesser went nor what she might have brought back with her. We do know that the crew is either incapable or unwilling to respond. As such, we have no first hand reports on the conditions inside the Kesser. To be blunt, we have no idea what might be inside her.

Perhaps her return was due to the actions of the crew. Perhaps, as some of the experts have suggested, the onboard AI was able to bring the ship back. Just perhaps, as some have suggested, something else brought the ship here-something that might pose a danger to humanity. In that case, you will be needed to deal with that threat.

Obviously, we do not think that the Kesser has been taken over by little grey men. But, we cannot dismiss that possibility simply because it seems so unlikely.

It is most likely that your function on this mission will be to assist the engineering and science teams in their efforts. It is my hope that this is all that will be required of you. But should your special skills be needed, I have complete faith in your abilities and judgment. Your overriding concern is the safety of the rescue team and humanity itself.

You have my complete confidence. Good luck and Godspeed. Dismissed. Major, a moment, if you would.”

Marine Major’s Briefing

If one of the investigators is the Marine major, s/he will receive the following additional briefing:

“It should come as no surprise to you that the debate over the military aspect of this mission was quite heated. While the scientists have good intentions, they do not seriously consider that the Kesser might contain a threat to earth. They are most likely right, but it has been decided, by the President herself, that if the Kesser contains such a threat, that threat is to be neutralized.

To this end, you are authorized to use any means you deem necessary. I trust your good judgment-you would not be in command of the Marine team if you did not have my complete confidence.

The science and engineering teams are, obviously enough, aware that your team will be armed. There were many complaints about that because of the obvious safety hazard presented by weapons. What they do not know, and what would no doubt send some of them into a panic, is that your team has also been equipped with sufficient explosive charges to destroy the Kesser.

One other thing, major, is that the Armstrong has been equipped with two ship to ship missiles. One of the missiles is armed with a tactical nuclear warhead. Yes, I know that is technically in violation of several treaties, but if we have to use it...the world will thank us for bringing it along. The ship’s captain is aware of their existence and is fully authorized to destroy the Kesser should the situation warrant. Yes, I know that seems extreme and perhaps even paranoid. But, if you knew some of the things I know...if you had seen...

Anyway, major, is my fondest dream that these concerns are, as one scientist said, ‘usual small minded military paranoia.’ If he is right, then we’ve wasted some of the taxpayers’ money. But, if he is wrong and the team went there unprepared, it could cost humanity very dearly indeed.”

The Journey

The following describes the journey to the USS Kesser.

The Shuttle

The shuttle, Cassiopeia, is somewhat similar to the shuttles of today, but is smaller and far more advanced. The cargo bay has been equipped with a special passenger module to carry the extra personnel to the USS Armstrong.

Once all the final safety checks are completed, the Cassiopeia will rocket upwards on a pillar of flame and quickly reach orbit. While exciting, the trip will be otherwise uneventful.

Once in orbit, the Cassiopeia will match velocities with the USS Armstrong and dock. The personnel will be transferred and the Cassiopeia will continue on to the International Space Station to drop off some cargo. The Armstrong crew will get the rescue team settled in and then the ship will start her burn.

Aboard the Armstrong

It will take the Armstrong two weeks, one day and 13 hours to reach the USS Kesser. During this time the rescue team will be kept busy with training and studying. The Armstrong was not originally designed to carry so many people; hence things will be a bit crowded onboard. Fortunately, space crews are subject to careful psychological screening and hence few interpersonal problems should arise during the journey.

Mission Information

The investigators can use the time to learn more about the Kesser. They will have full access to her deck plans, the crew's personnel files, security codes and all the available information about the initial mission and her current status. They can also access resources on earth via the Armstrong's communication system.

While the investigators will have a wealth of technical data and other information, they will find little that is truly unusually with two exceptions. The first is the Markelson drive system and the second is Dr. Markelson himself.

Investigating Dr. Markelson

The investigators are likely to have questions about Dr. Markelson. If they look at the basic mission briefing files and public

information sources, they will find some oblique references to a "troubled time" in Dr. Markelson's past. If the investigators succeed on a Library Use roll, they can (via the link to earth) find the university records that show when Dr. Markelson's employment was ended. The records do not specify why his employment was ended. If the investigators decide to try to hack into the university systems, they can do so with a Computer Use roll. If they succeed, they will find records that show he left because of medical reasons. His file also contains a letter from the department chair of the time. The letter (which is actually an email file but is still called a "letter" out of tradition) states in vague terms that Dr. Markelson's behavior became erratic and that one day he simply left campus and did not return.

Investigators can also make an official request for information about Dr. Markelson. The request will be honored and the investigators will learn that Dr. Markelson apparently suffered from a life crisis and left the university. There is no record of him seeking psychiatric help or any police records involving him. His passport file shows that he traveled extensively during the five years before his triumphant return to reveal the prototype of his gate system. He visited almost every country in Europe as well as several in Asia. The expert opinion is that Dr. Markelson suffered a fate not uncommon to geniuses of his caliber—he had a severe life crisis brought on by his obsession with intellectual matters. He was, of course, evaluated by NASA as part of his training for the mission and was found to be competent. If the investigators wish to speak to the psychiatrist who evaluated him, they can do so. Dr. Leslie Jones will say that Dr. Markelson seemed a bit odd, but no more than one would expect. She will, however, pause and say that his responses to the standard tests were "textbook perfect, almost as if he had



studied for the exam.” She will be half joking, but she is quite right. Dr. Markelson was insane by human standards, but was able to pass himself off as normal by always giving acceptable responses. While the Kesser Action Committee did seriously consider the possibility of a breakdown on the part of Dr. Markelson, the experts deemed that this would be very unlikely. In their opinion, he seemed sincerely devoted to the success of a project that exemplified his life dream. They based this opinion on interviews with former colleagues as well as computer models based on his psychological profile. The experts, of course, note that psychology is not an exact science and that it is not beyond the realm of possibility that Markelson suffered a relapse and played a role in what happened to the Kesser.

The investigators can also speak with Dr. Andrea Skorksi. Because of her work on the Merkelson gate system, she is part of the rescue team. Her responses to questions about Dr. Merkelson and his gate system are given below.

Investigating the Merkelson Gate System

The investigators will most likely also want to investigate the gate system. While it is classified as top secret, the rescue team members have access to the available information. The investigators will know that some of the best minds on earth have gone over every scrap of data on the gate system for years and have learned almost nothing about how the system actually worked. As such, they only have some vague and very technical theories about what might have gone wrong with it. Other theories about the incident focus on how the nature of gate space might have affected the crew and the ship.

One popular theory is that the gate space is fundamentally different than normal space in terms of the flow of time. As such, the Kesser might have only been gone a short

time from the standpoint of her crew. Another popular theory is that gravity affects gate space in many ways and the gate space far from earth might have qualities that did not manifest in tests on and close to earth. These qualities, it has been speculated, might be quite inimical to humans. Some have even speculated that gate space might be inhabited, but this theory is considered to be the least plausible.

Some experts have also put forth the hypothesis that the gate system worked properly and some other failure, either human or mechanical, was the cause of the disaster. Those who had clearly read far too much science fiction even speculated that the ship’s AI system might have gone rogue. This was, naturally enough, dubbed the “Hal theory.” The consensus among the experts is that the ship’s AI, Julian, most likely had no role in the disaster.

Others have suggested more mundane computer failures or problems with the life support or propulsion systems. One popular theory is that there was a fire or explosion onboard the Kesser—proponents of this theory point to the hull damage as well as the open outer airlock door. In any case, there are many theories but little solid information.

If the investigators are persistent in looking for technical data on the gate system, they will find that there is no information whatsoever on the inner workings of the key components of the system. They will also learn that Dr. Merkelson either hid or destroyed all other copies of the components and hence no one has been able to study them. In short, the essential workings of the gate system are a black box to everyone other than Markelson.

The investigators might find it odd that Dr. Merkelson would be allowed to keep such critical information away from his colleagues and the government. If they ask about this, they will be informed that Dr.

Merkelson made this a non-negotiable condition for the use of his technology and his assistance. Because of the importance of the technology and Dr. Merkelson's willingness to stake his own life on its success, his condition was accepted. Since then NASA has adopted a strict policy of not allowing such a condition (not that anyone else has made such a request).

It will quickly become evident that investigating the gate system via information available on earth will quickly come to a dead end. Fortunately, the investigators can speak with Dr. Skorksi.

Dr. Andrea Skorksi

Dr. Skorksi worked with Dr. Merkelson for several years on the gate project and was closer to him than anyone else. She sincerely hopes that the mission will be able to rescue Dr. Merkelson and will do everything she can to achieve that end.

If she is asked about Dr. Merkelson, she will be fairly open. It will be evident that she thinks very highly of him. A successful Psychology roll will reveal that her devotion is both sincere and platonic. If the investigators decide to assess her sanity, they will find that she is quite sane. As long as the investigators remain civil and professional, she will be happy to answer their questions and will cooperate fully.

While she can talk for hours about Dr. Merkelson and his gate system, the following presents what the investigators are likely to find the most useful and the most interesting.

First, Dr. Merkelson was extremely secretive about the key components of the gate system and would allow no one else to work on these components or even see them. The components were always contained within a metal shell and installed into the other parts of the gate system by Dr. Merkelson. He warned against tampering with them and said that doing so would be

“dangerous...even fatal.” Dr. Skorksi will also say, “Not surprisingly, there were a few occasions when people let their curiosity...or greed...get the better of them. I know of two incidents in which someone was badly injured trying to get into one of the shells. There were also some rumors that one person had even been killed.”

She will freely admit that she wanted to know about what was hidden beneath the shells, but valued working on the project far too much to risk it. She will say, “I also value my health and my life.”

Second, most of the other components of the gate system are actually fairly mundane. They include computer systems, power systems, and so forth. She will say that they differ little from systems used to control and power conventional drive systems. These systems have been thoroughly examined and shed no light on how the key components function-beyond the fact that they use a great deal of power, receive and send inputs to the computer systems and output an energy that can open a gateway that leads outside normal space-time.

The gateway energy systems are somewhat unusual in that they are designed to transmit an energy that only Dr. Merkelson seemed to understand. These systems channel the energy to transmitters that actually send the energy needed to open the gateway. These systems, not surprisingly, push the boundaries of physics and engineering and Dr. Skorksi will freely admit that she does not fully understand fully how they work. Her best theory is that the gateway energy alters the transmission systems on the quantum level and hence changes the fundamental nature of the system. However, Dr. Merkelson did not consider them to be part of the essential secret of his gate system and regarded the theory behind them as “mere child's play.”

If asked about her research over the years, she will say that she was able to make



extensive refinements to the non-key components and has developed a multitude of theories about the key components. She will freely admit that the key components remain a mystery to her.

If asked why she is along for the mission, she will state the obvious-she is the foremost expert in the gate system and will be needed to examine the systems on the Kesser. She will point out that they will need, for the sake of safety, to disable the gate system (without damaging it) for the return trip of the Kesser to earth.

Third, Dr. Merkelson was devoted, perhaps even obsessed, with getting humanity to the stars. He often talked about watching science fiction movies with his father and how this led him to dream of being able to “walk on another world under an alien sun.” She is convinced that Dr. Merkelson was sincere and would do anything to make his dream a reality. If the investigators suggest that Dr. Merkelson might have sabotaged the mission, she will calmly insist that is almost certainly beyond the realm of possibility. If pressed, she will recount a multitude of anecdotes about Dr. Merkelson’s devotion to his dream and to the success of the mission.

If the investigators ask about the trouble in his past, she will make her opinion clear: Dr. Merkelson suffered from stress and needed a break from the rigors of the academic setting. She will point to his successful return and his passing all psychological evaluations as evidence that whatever had gone wrong then was clearly a matter that was left in the past. She will point out that in order for his past condition to be relevant to the failure of the mission, he would have needed to suffer a relapse between the time of his last evaluation and when he activated the gate system. She, and the experts hired by NASA, regard that as extremely unlikely.

Fourth, if she is asked about the cause of the first mission’s failure, she will say that she has three hypotheses. The first is that the gateway system functioned in an unexpected way. She will point out that gravity affected the gates on earth by limiting their range significantly and that lower gravity enabled greater range for the gates. Perhaps, she will suggest, the Kesser created a super gate and it has taken years for the ship to journey there and back. Her second hypothesis is that the ship made the first transition successfully but suffered an accident en route or when she arrived. On this theory, the crew had to spend years repairing the gate system and was only able to return now. Her third hypothesis is that something went terribly wrong within the gateway space itself. While the test runs showed that the transition between gates was almost instantaneous, perhaps something strange and terrible happened.

Naturally, she will be willing to discuss matters further with the investigators and other team members.

The Kesser’s Crew

The investigators will also have access to the files on the Kesser’s crew. Not surprisingly, they were all top people in their fields and carefully screened before being selected for the mission. The experts who did the screening were quite thorough and considered a multitude of possibilities ranging from the obvious (personal conflict and sexual attraction) to the unusual (favorite foods, music play lists, and astrological signs).

After the Kesser failed to return, their backgrounds were investigated in excruciating detail. Friends, relatives and associates were questioned. Their personal possessions were examined with great care. The end result was that nothing was found to help explain what might have happened to the Kesser.

Naturally, all the crew members had their flaws, foibles and weakness, but the consensus of the experts was that none of these qualities were likely to have lead to any situation that would have spelled disaster for the Kesser. The experts do admit that they might have missed something and that people can, of course, act in ways that are contrary to their normal patterns of behavior.

The return of the Kesser led, obviously enough, to an extensive re-examination of the crew records. Nothing new was found, however.

Crew Roster, USS Kesser

Captain Hillary S. Clanson
First Officer Andrew Takei
Navigation Officer Rodney Pike
Medical Officer Yu Chen
Computer Systems Officer Sanja Balikrishnan
Chief Engineer Dmitri Tarksi
Engineer David Pitzen
Engineer Sandra Lewis
Engineer Karl Zubrin
Engineer George Medell
Dr. Kenneth Markelson
Dr. Stuart Foster
Dr. Henry Morricone
Dr. Alisha Russell

Deck Plans

The following details the ships in the adventure. The investigators have access to the deck plans of the USS Kesser and their own ship, the USS Armstrong. Naturally, the will not initially have access to information about the conditions aboard the USS Kesser.

USS Armstrong

The USS Armstrong is a modular cruiser designed on the same flexibility principle as the original American space shuttle. Like that shuttle, the Armstrong can be equipped

with various modules that enable it to undertake different missions. Unlike the shuttle, the Armstrong is strictly a space vessel and is never intended to enter the earth's atmosphere.

The Armstrong and other vessels of the same type are primarily used to maintain satellites, supply the space stations, transport cargo and personal to the moon, conduct experiments and impress the world with America's technical prowess.

The Armstrong's crew consists of NASA and United States Air force personal. While the ship is technically not a military vessel, it does operate with military style discipline.

Crew Roster, USS Armstrong

Captain Natalie Weaver
First Officer Lt. Richard Obama
Navigation Officer Sally Lee
Chief Engineer Kelly Graham
Mission Specialist Heather Roam

Technical Team

Dr. Andrea Skorski
Dr. Helen Abraham
Dr. Ivan Onassis
Engineer Ruth Redwood
Engineer Samuel Cohn

Medical Team

Dr. David Rosenberg
Dr. Ellen Li

Marine Team

Major Thomas Whitmore
Lieutenant Carla Brown
Sergeant Russ Waters
Sergeant Sarah Winters

USS Armstrong Deck Plans

The gray areas on the deck plans do not represent solid hull, but rather the ship's systems that occupy most of that space.

Since the ship is a space vessel, all the hatchways on board are airtight. They are



operated manually, exactly like watertight doors on submarines. The airlocks have safety systems that allow only one door to be open at a time. These safety systems can, of course, be overridden by using Electronics. Alternatively, they can be physically destroyed.

The Armstrong does not have an artificial gravity system, hence those onboard will be in zero gravity conditions.

Deck One

This deck is actually a cargo module that has been attached to the ship. It can, after the proper procedures have been followed, be jettisoned from the vessel. Naturally, there are multiple safety systems to prevent the module from being jettisoned by accident.

- 1. Cargo Dock:** This area functions as a large cargo airlock and is used to dock with other vessels.
- 2. Cargo Bay:** This is a cargo storage area. Supplies for the mission are stored here including parts and tools for repairing the Kesser. Access to the ship is via a hatch which connects to the center of the Armstrong's main corridor.

Deck Two

This deck consists of the ship itself as well as four attached modules. The modules can be jettisoned from the vessel, but there are numerous safety (such as physical keys) and failsafe systems to prevent that from happening by accident.

- 1. Bridge:** This is the command bridge of the ship and contains the main controls for the vessel.
- 2. Operations:** This area contains the controls and instruments for functions not directly relating to the ship itself. Normally, these controls are used for specific mission modules attached to the ship. For the current mission the controls have been configured to

pilot ROVs and coordinate mission operations.

3. Corridor: A corridor.

4. Captain Weaver's Stateroom: This single occupancy stateroom contains a desk, zero gravity "bed", and zero gravity bathroom facilities.

5. First Officer Obama's Stateroom: A single occupancy stateroom.

6. Navigation Officer Lee's Stateroom: A single occupancy stateroom.

7. Chief Engineer Graham's Stateroom: A single occupancy stateroom.

8. Main Corridor: This corridor runs from the command section to engineering. In the center of the corridor is an airlock system that is intended to provide an extra measure of safety. Access to the dorsal (top) and ventral (bottom) modules is via hatches in the middle airlock.

9. Engineering: This is the engineering section of the ship. This area contains the direct controls for the ship's power plant and drive systems. The area also provides access for repairs and maintenance. There is a small airlock in the aft section of the ship that is used to allow EVA maintenance and inspection of the drives.

10. Dr. Skorski's Stateroom: A single occupancy stateroom.

11. Dr. Abraham's Stateroom: A single occupancy stateroom.

12. Mission Specialist's Roam's Stateroom: A single occupancy stateroom.

13. Engineer Redwood's Stateroom: A single occupancy stateroom.

14. Common Area: This is a common area for socialization and eating. It also functions as the medical treatment area, should the need arise.

15. Dr. Onassis' Stateroom: A single occupancy stateroom.

16. Dr. Rosenberg's Stateroom: A single occupancy stateroom.

17. Dr. Li's Stateroom: A single occupancy stateroom.

- 18. Engineer Cohn's Stateroom:** A single occupancy stateroom.
- 19. Galley:** This is the food preparation area for the ship. Naturally, it is designed for zero gravity cooking.
- 20. Lieutenant Brown's Stateroom:** A single occupancy stateroom.
- 21. Sergeant Waters' Stateroom:** A single occupancy stateroom.
- 22. Fitness Area:** This area is equipped with zero gravity fitness equipment designed to help offset the effects of weightlessness.
- 23. Sergeant Winters Stateroom:** A single occupancy stateroom.
- 24. Major Whitmore's Stateroom:** A single occupancy stateroom.
- 25. Equipping Room:** This room holds vacuum suits, CO2 guns, and the other equipment for EVA.
- 26. Airlock:** This airlock provides access to the ROV bay.
- 27. ROV Bay:** This area holds the mission's three space ROVs and provides a launching area for them. Access to space is via an automatic door. The door's safety system prevents it from opening when the airlock to the bay is open. The bay is normally under pressure but is depressurized for ROV launch or when it is in use as an air lock. The bay can also function as a docking station as equipment to connect to other vessels is located on the exterior of the bay.

Deck Three

Like the first deck, this is a cargo module that has been attached to the main ship.

- 1. Arms Locker:** This area holds the weapons and equipment for the Marines. The locker is armored and reinforced to prevent accidents from damaging the ship.
- 2. Cargo:** This area holds supplies and provisions for the mission.
- 3. Special Component Storage:** The door to this area is secured and requires both a code and a physical key to open. Captain Weaver and Major Whitmore know the code

and each has a key. This area is actually a launch system for two Harpoon VII ship to ship missiles. One has a conventional warhead, but is capable of destroying a ship with a direct hit. The other has a tactical nuclear warhead that is capable of vaporizing a ship. Only Major Whitmore and Captain Weaver know that the weapons are on board. The weapons require a code input from both the Captain and the Major before they will arm. This can be bypassed by Computer Use or Electronics, but is rather difficult (DR = Hard) and a failure will trigger a safeguard that will render the weapon unusable.

USS Kesser

While the Kesser was constructed as a new vessel, it is based on the same hull design used for testing drive and power systems. Because of this, the ship is relatively large and has the command section on the end of a boom extending away from the main body of the ship. The boom was intended to keep the command section at a safer distance from the systems being tested and to also provide a way for the command section to be separated in case of a disaster. The ship does not have artificial gravity, so those aboard will be in zero gravity.

The ship itself has sustained some damage from the invasion of the creatures. The port airlock is damaged and most of the interior doors were forced open. The creatures were mainly interested in the crew, but did some damage inadvertently.

The ship's power plant is still operating in a low power mode. Some of the light panels still function, but others have been damaged or have ceased to operate.

The ship still contains an atmosphere. The air where the creatures have been is unspeakably foul. This air is treated like a poison with potency 14 (match this against the investigator's CON). If the investigator is overcome, she will be horribly sickened



by the stench and be able to do little more than retch for 1D4 minutes.

The areas where the creatures have been are also stained with residue and slime from their bodies. If the slime is analyzed, a Biology roll will reveal that the DNA in the material matches no known species. However, it will be found to have unusual similarities to human DNA.

Kesser Deck Plans

The gray areas on the deck plans do not represent solid hull, but rather the ship's systems that occupy most of that space.

Since the ship is a space vessel, all the hatchways on board are airtight. They are operated manually, exactly like watertight doors on submarines. The airlocks have safety systems that allow only one door to be open at a time. These safety systems can, of course, be overridden by using Electronics. Alternatively, they can be physically destroyed.

Deck One: Pod Bay Deck

- 1. Pod Bay:** This area holds the Kesser's two work pods. The pod bay door opens at the front and does so directly into space. Both pods are present in the bay. This area has not been entered by the creatures.
- 2. Equipment Room:** This area holds two standard vacuum suits, two heavy vacuum work suits, spare parts, and tools for working on the pods. Access to this room is via a hatch set in the ceiling. This area has not been entered by the creatures.
- 3. Airlock:** This airlock is large enough to hold two people at a time.

Deck Two: Main Deck

- 1. Bridge:** This is the bridge of the ship. It contains the controls for the vessel and its systems. There are view ports on the front of the ship. While they are not needed for navigation, they were installed out of tradition. There is a hatch on the deck that

allows access to the first deck. The hatch in the ceiling provides access to the third deck. This hatch has clearly been forced open—the metal is bent and one of the hinges is cracked. There are stations on the bridge for the captain, helmsman, navigator, chief engineer and computer officer. Some of the instrumentation is still functioning, but some of the indicator lights have stopped working.

2. Boom Corridor: The boom corridor provides access to the main body of the ship. The boom itself contains various electronics and other components (the gray area on the plans) that are part of the ship systems. There are various access plates in the corridor that enable people to work on these systems, should the need arise. The hatch to the bridge is open and shows clear signs of having been forced. The locking mechanism is broken. The corridor is stained with residue from the creatures that invaded the Kesser.

3. Main Airlock: The ship's main airlock. There are docking connectors on either side of the ship. There are external and internal airlock controls. The external door to the port airlock is damaged and open. The interior door is also been damaged and shows clear signs of having been forced. It can be sealed to allow the airlock to function properly again. The external starboard airlock door is open, but it and the interior door are undamaged. The hatches to the boom corridors have been forced open but are now closed. They still provide an airtight seal.

4. Boom Corridor: Several of the light panels in this corridor have been damaged leaving it dimly lit with flickering light. The headless body of Dr. Alisha Russell walks up and down the corridor.

5. Gateway Focusing Control: This room contains the instrumentation and equipment for one set of the gateway focusing systems. The bodies of Morricone and Foster, which

have been converted into Little Things, sit at their posts in this room.

6. Gateway Focusing Control: Dr. Markelson is in this room. His body has been horribly altered by the creatures, but he is still alive. He has turned off the room's camera system.

7. Computer System Officer Balikrishnan's Stateroom: A single occupancy stateroom with a desk, storage, a "bed", and zero-gravity bathroom facilities.

8. Captain Clanson's Stateroom: A single occupancy stateroom.

9. First Officer Takei's Stateroom: A single occupancy stateroom.

10. Navigation Officer Pike's Stateroom: A single occupancy stateroom.

11. Pylon Access: This room provides access to the port gateway pylon. There is a single person airlock that allows access to the pylon.

12. Common Area: The common area of the ship that functions as a mess hall and living room for the crew. This area was used as the playground for the creatures. The place stinks even worse than the other areas. Drifting about the room is what is left of Pike, Tarksi, Takei, and Balikrishnan.

13. Pylon Access: As above.

14. Galley: This is a zero-gravity kitchen. The food stores have been ripped open and the kitchen has been extensively damaged by the creatures.

15. Chief Engineer Tarksi's Stateroom: A single occupancy stateroom.

16. Medical Officer Chen's Stateroom: A single occupancy stateroom. The remains of Yu Chen float in the stateroom with the contents of her medical kit orbiting about her like satellites. If an autopsy is performed, it will be found that she injected herself with an instantly lethal combination of medicines.

17. Dr. Markelson's Stateroom: A single occupancy stateroom.

18. Zubrin & Medell's Stateroom: A single occupancy stateroom.

19. Foster & Morricone's Stateroom: A double occupancy stateroom equipped with two desks, two "beds", and zero-gravity bathroom facilities.

20. Lewis & Russell's Stateroom: A double occupancy stateroom.

21. Pitzen & Zubrin's Stateroom: A double occupancy stateroom.

22. Engineering: The main engineering center. The area contains the direct controls for the ship's drives and power plant as well as access to the machinery. There is a small airlock in this area that allows the engineers to leave the ship to inspect or repair the external parts of the ship's drives. The outer airlock door was forced open, but the interior airlock door is welded shut and has additional metal objects welded across it.

The door to the corridor has also been welded shut. The outside of the door is badly scarred from the attempts by the creatures to enter the engineering deck.

23. Drive access: This area provides direct access to the drive systems in order to facilitate repairs. When the ship's drive is in operation, this area can be rather dangerous. The hatches have been welded shut from the inside. The remains of Zubrin and Pitzen are here. Seeing what was invading the ship, they fled into the drive access area after welding the doors shut. After seeing the fate met by the other crew via the onboard cameras, they decided to kill themselves.

24. Drive access: This area provides direct access to the drive systems in order to facilitate repairs. The access doors are welded shut from the inside. The remains of Lewis and Medell are here. Like Zubrin and Pitzen, they elected to kill themselves.

25. Pylon Corridor: This corridor provides access to the mechanisms and electronics contained in the pylon as well as access to the main gateway nacelle.

26. Gateway System Access: This area provides access to the port gateway systems. The critical systems are protected by locked,



armored plates. The electronic keys are with Markelson.

27. Pylon Corridor: As above.

26. Gateway System Access: As above, but for the starboard systems.

Deck Three

1. Emergency Storage: This area contains survival supplies such as rations, water, oxygen canisters and medical equipment. This area is intended for use in the event of a disaster that damages or destroys the main part of the ship. Four of the survival kits have been torn open.

2. Emergency Quarters: This area provides emergency quarters for the crew. It contains the basic amenities needed for survival. The hatch into this level has been forced open. Four pistols from the survival kits (9mm automatics) float in the room along with several shell casings. The body of Captain Clanson floats here. The body has been horribly mutilated and has a gunshot wound (self inflicted) in the head.

The Whale

The Whale is a Chinese tanker vessel. As such, it is designed to transport fuel to other vessels and space installations. It is an older vessel and poorly equipped for a rescue mission, but it can draw on the main tanks to fuel its own engines. This gives it exceptional range.

The ship has a crew of eight. The ship is less automated than American ships and many tasks are performed manually. Like almost all space vessels, the hatches are airtight.

The Whale Deck Plans

Deck One: Tank Deck

1. Tank: This is a fuel tank.

Deck Two: Main Deck

1. Bridge: This is the ship's bridge with stations for the pilot, navigator and chief engineer. When the ship is taken over, the bodies of the navigator and the helmsman will be on the bridge, controlling the flight of this ship.

2-9. Staterooms: These are small, single occupancy cabins.

10. Tank: This is a fuel tank.

11. Engineering: This is the engineering section. The direct controls for the ship's engines and power plant are here as well as access to the machinery.

Deck Three:

1. Electronics: This area contains the main electronics of the ship such as the main computer, guidance systems and control connections.

2. Airlock: This is the ship's airlock.

3. Equipment Locker: This area contains the vacuum suits for the crew as well as basic equipment for EVA and repairs.

4. Common Area: This is the ship's common area. It contains some basic exercise equipment and some entertainment devices. The gateway denizen will take up occupancy here and spend its time entertaining itself with the remaining crew members.

5. Common Area/Galley: This is a common area as well as the ship's galley. There is a hatch on the floor that provides access to the main corridor on deck two.

6. Walkway: This walkway provides access to the engineering section of the ship. It crosses over the tank.

7. Access: There is a hatch on the floor of this area that opens into the engineering section on deck two. There area has an airlock in case of an accident in the engineering section.

Action

The following sections provide a guide to the action that will take place during the adventure. In the first part of the action, the investigators will learn that the Chinese have sent a vessel to board the Kesser. In the second part of the action, the investigators will arrive at the Kesser and confront the horrors infesting the vessel. In the third part, the investigators will have to decide what to do about the Chinese vessel and its terrible cargo.

Action Part One: A Chinese Intervention

When the Kesser returned, officials and scientists in other countries began considering whether to risk sending their own “rescue missions” to the vessel. While most countries lacked either the means or the desire to do so, a group of Chinese officials decided that gaining access to the Kesser’s technology was worth the risk of sparking a major international incident. Luckily for the Chinese, one of their tankers was already deployed on a refueling mission that would place it in ideal position to reach the Kesser.

The Whale

Two days after the Armstrong departs, the Chinese vessel will deviate from its normal course and head towards the Kesser. The crew of the Armstrong will be contacted via a secure laser communication beam and Dr. Henry Slate will tell them the following:

“We just confirmed that a Chinese tanker, the Whale, has left its normal course and is on its way towards the Kesser. Since the ship is a tanker, it has considerable fuel reserves and we estimate that it will reach the Kesser twenty one hours before the Armstrong.

Obviously, the State Department has demanded that the Whale return to its

normal course and the President is planning on calling a press conference at the White House within the hour. The Chinese insist that their efforts are strictly humanitarian and that the extra hours could make the difference between life and death.

The international lawyers are in a fine frenzy over this. The Chinese claim that they are acting within the law by rendering assistance to a ship in need. The lawyers at State are countering that the Kesser is American property and is not to be considered salvage or as a vessel in immediate distress. International opinion is somewhat divided. China’s allies are supporting her. Our allies are with us. The neutral countries are divided. Some see China’s actions as bordering on piracy while others hope that China will share some of what it finds with them. Countries with grudges against us are cheering for China.

We are currently trying to resolve the situation diplomatically, but the Chinese seem very serious about getting to the Kesser first. They seem confident that they can get away with it. Maybe they can.

In regards to your mission, you are to remain on course and rendezvous with the Kesser at the scheduled time. We will keep you updated on events and orders will be sent regarding the actions you should take.”

The crew will have the opportunity to ask questions and will be given data on the Whale. The government is not sure what to do at this point and will not issue specific orders or be able to provide concrete answers to questions about what action to take. It will be evident that the officials are divided between a desire to avoid an international incident that could lead to war and a desire to keep the Chinese off the Kesser.

Over the rest of the journey, the Whale will continue to close in on the Kesser. There will be various propaganda broadcasts

from China showing the crew of the Whale preparing for their “glorious rescue” of the Kesser survivors. There will be extensive news coverage of the diplomatic and legal battles over the matter, but it will soon become evident that the Chinese intend to board the Kesser and nothing short of war will stop them.

The crew of the Armstrong will be in regular contact with the officials on earth. Much of the discussion will be technical with an emphasis on how much the Chinese crew is likely to be able to learn in the time they have on board and how much of the Markelson system they will be able to take apart and get on board their ship. There will also be constant attempts to contact the Kesser, all of which will fail. The media will also want to interview the Armstrong crew about the situation. The government will allow this, although the crew will be urged to be diplomatic and to stick close to the official line.

Twelve hours before the Whale is to reach the Kesser, the Dr. Henry Slate will contact the Armstrong and say the following:

“The President has decided to not risk war over the Kesser. The Chinese will dock with the vessel and will, no doubt, ransack the ship as quickly as they can. The Chinese government says that they will transfer any survivors to the Armstrong for the return trip to earth.

Your orders are to dock with the Kesser, receive any survivors and escort the Chinese off the Kesser. While you are to secure the Kesser and the technology on board, you are to avoid any action that would start an international incident, such as attempting to board the Chinese vessel by force or shooting any of the bastards.

However, you have full authorization from the President to use any means short of violence to secure the Kesser and to protect the Markelson technology.

The Chinese have offered to refuel the Kesser and the State Department is considering this offer. If you believe that the refueling will assist you in your mission, you are authorized to accept their aid.

Aside from the matter of the Chinese, your mission remains the same.”

The crew will once again have a chance to ask questions. Dr. Henry Slate will make it clear that violence is not an option. However, he will be willing to support more peaceful and creative approaches, such as bribery. He will add that the State Department is willing to provide the Chinese crew with money and political asylum if they are willing to turn over what they find to the Armstrong crew.

A Chinese Disaster

The Chinese propaganda agencies will begin releasing video from the Whale as it approaches the Kesser. There will be a delay due to the distance but also a delay as the Chinese officials make sure that the video is suitable for the world to see.

Although the Whale’s camera and telescope systems are not on par with those of a scientific vessel, the images being broadcast will reveal that the Kesser has suffered damage during its long absence. The hull is scarred and pitted in places as if it had been exposed corrosives. A few sections of the hull are strangely warped and distorted. The port airlock’s outer door is open and the hull around the door shows extensive pitting and scarring. The outer airlock door shows signs of damage as well, which will lead at least one commentator to remark that it looks like it was forced open from the outside.

Since the Whale is not properly equipped for the mission, the crew will simply bring it near the Kesser for a closer look and attempt to establish radio contact. The Whale will then move alongside the starboard side of

the Kesser. The crew will then attach an EVA line to the Kesser with a magnetic grapple. Two crewmembers will cross over to the Kesser. This will be shown on the last video that the Chinese will release to the media. After that, they will issue various vague and evasive statements about how the mission is progressing nicely and that everything is going according to plan. In reality, the Chinese mission has been plunged into horror and death.

When the crewmembers board the Kesser, they will quickly find that one of the creatures that boarded the Kesser in gate space has remained on board. They will have just enough time to scream before it kills them. The creature will animate one of the corpses and send it across to the Whale to open the airlock. It will then surge across and take over the Whale, eager to have humans all to itself. Although the creature itself is not intelligent, it will be driven by some strange urge to direct what remains of the crew to set the Whale on a course towards earth.

When it is determined that the Whale is departing from the Kesser, the Chinese officials will believe that the crew was able to get the Markelson device and they are bringing it back. As such, they will be very eager to have the ship return. They will be somewhat dismayed by the lack of communication with the ship, but will tell themselves that the crew is maintaining communications silence.

The Armstrong crew will be able to observe the Whale approaching and then leaving the Kesser. The Armstrong crew will receive the following communication from Dr. Henry Slate:

“As you know, the Whale sent two crewmen onboard the Kesser and then the vessel departed rather abruptly. Some have speculated that the Chinese were able to find what they wanted and have left to bring it

back to their scientists. However, based on the layout of the Kesser and the complexity of the gateway system, it seems almost impossible that they were able to remove any significant portion of the system.

There has been some speculation that the Whale suffered some accident and is racing back to earth before her systems fail completely. However, this seems somewhat unlikely. After all, they could have remained at the Kesser and waited for you to arrive to help them.

The most worrisome possibility is that the Chinese found Dr. Markeleson and now have him on board. This would explain their rapid departure and the lack of communication from the Whale. The Chinese refuse to say anything, which merely fans the flames of suspicion.

We have the capacity to intercept the Whale before it reaches earth, but doing so would almost certainly lead to a process of escalation. Before risking that, we need to know if Markelson is on board the Whale.

As such, you are to continue to the Kesser. In addition to your original mission, you must ascertain what the Chinese took from the Kesser.”

The investigators will, as usual, be able to ask Dr. Henry Slate questions. However, he does not have any additional information to offer about the situation. If the investigators ask about taking action against the Whale, they will be told that they are to do no such thing. He will make it clear that the President has yet to decide what to do about the situation and that the investigators are not to initiate hostilities on their own. He will also add that the Armstrong’s mission is critical and hence the crew should focus on that.

If the investigators decide to take action against the Whale anyway, the other rescue team members will oppose them. Should the investigators mutiny and take the



Armstrong, they can try to intercept the vessel. Alternatively, they can launch one of the missiles to destroy the Whale. How this plays out is left to the keeper and the players. Information is provided, below, about the situation on the Whale.

Action Part Two: The Kesser

The following is a guide to running the events near and onboard the Kesser. This guide lays out the likely course of events, but the keeper will need to adjust events based on what the players actually decide to do.

Approaching the Kesser

The mission guidelines call for an initial cautious approach to the Kesser so that any potential hazards can be detected before the rescue crew boards the vessel. Of course, the approach of the Whale did supply a considerable amount of information. However, the Captain will stick with the cautious approach anyway.

As the Armstrong approaches the Kesser, the crew will be able to make closer observations. As they saw on the Chinese videos, the Kesser's hull is scarred and pitted in places as if it was exposed to a corrosive agent. An Idea roll will reveal that the damage actually seems to have something of a pattern to it-almost as if large things were grasping the Kesser. Some parts of the hull are strangely warped and distorted. An Idea or Physics roll will reveal that the warping does not appear to be the result of a physical bending of the hull. Rather, the distortion seems to be the effect of something other than kinetic force.

The port airlock door is still open and shows signs of damage. An Idea or Physics roll will reveal that the door does seem to have been forced from the outside-there are what appear to be points where force was

applied to the door. The marks do not seem to be those that a machine would make since they are not sharp and distinct.

The Armstrong will continue to approach the Kesser and make an orbit about her at a distance of 10 kilometers. They will be able to see that the starboard airlock door is still open, but does not show signs of having been forced.

Meanwhile, the attempts to contact the Kesser and to link with her AI system will continue. As before, this will yield no results. The Captain will have the vessel match speed with the Kesser (so they will be at rest relative to each other) and will order the launch of an ROV.

ROV Mission

The mission guidelines call for an ROV to be sent to the Kesser to check the condition of the ship and to check for potential dangers such as structural problems and radiation.

Guided by the able hands of Specialist Roam, the ROV will survey the outer hull of the ship. The closer examination will reveal the finer details of the damage to the ship. The ship was clearly subject to a powerful corrosive in numerous places. Further, it will be clear that the port airlock was forced open. A Physics roll will enable an investigator to create a model of how the door was forced open. While this will not reveal all the details, it seems that sharp objects penetrated into the seams of the door and that the outside of the door was gripped by something that bonded to the hull using some sort of corrosive adhesive. The airlock locking mechanism was broken by the force, indicating considerable power.

When the ROV enters the port side of the airlock, it will find that the inner door was also forced open. It is now closed, although the damage to the door prevents an airtight seal. It will also be found that the door is jammed shut.

The ROV will then be sent to the starboard airlock. The outer door is open, but shows no signs of being forced. The interior door is closed (it closed automatically).

The ROV will next be sent to look through the bridge ports. As the ROV moves up against the hull, the viewing monitors on the Armstrong will suddenly flicker. For about a second a ghostly shape will be seen on the monitors. The shape looks vaguely human and is a faint bluish gray in color. It will seem to move from the Captain's chair and out of sight. The shape is, in fact, the ghost of Clanson. The Captain will direct the ROV to move to the other port, to try to get a clearer angle of view. There will be a split second image of the shape moving directly at the port and then contact will be lost with the ROV. Inertia will keep it moving and it will drift away from the Kesser. Roam will attempt to regain control of the ROV, but it will be evident that it has suffered a complete systems failure. Even the ROV's emergency lights and beacon will fail. Roam will remark that it is all but impossible for all the backup systems and the emergency beacon to fail at once. If asked about what could cause that, she will say that it would require massive damage the ROV or some sort of EMP. What has happened is that Clanson's ghost has drained the ROV of energy.

The Captain will order a second ROV sent out to recover the first one. When the ROV is recovered and returned to the ship, the technical team will examine it (after it has been checked over using the other ROV).

The technical team will find that the ROV's battery systems have been completely drained, including the tiny battery on the ROV's motherboard. The battery casings are melted in places, as if their energy was somehow siphoned through them. The ROV can be put in working order again by replacing the batteries with spares from the ship's stores.

After the ROV is back in working order, it will be sent back to the Kesser. The Captain will have Roam send the ROV back to the bridge ports of the Kesser. The ROV will be able to get clear camera shots through the ports, revealing that the bridge is empty. Some of the instrumentation is still active, indicating that at least some of the command systems might be function.

The Captain will then order the ROV to make a direct link to the Kesser's computer and control systems. The data link will reveal that the Kesser is still under pressure and that her power plant is still operating on standby mode.

The AI, Julian, is in failure standby and will randomly send an automatic "help me" signal. Some of the onboard camera and microphone systems are still active and can be tapped into using Computer Use. The ship's mission recordings are handled by the AI, hence the AI will have to be brought online to gain access to them.

The Captain will ask the rescue crew for input on how to proceed. She will suggest that they use the onboard cameras to get visual data about the Kesser before proceeding to a boarding operation.

Lights, Cameras, Action

The Kesser was equipped with interior and exterior cameras. While they were intended as a safety feature, they were also supposed to record the mission for the later creation of a documentary on the success of the mission. For reasons of privacy, cameras were not installed in the living quarters (7-10, 14-21).

The interior cameras are equipped with microphones and can be swiveled on their mounts. The interior cameras are working in all areas except are 6 (because Markelson turned the camera off) and area 12 (because the creatures broke the cameras).

Since the rescue crew has the passwords for the camera system, they will be able to



use the cameras to view the interior of the ship. In general, the interior of the ship shows signs of harsh usage. There are scars, marks and stains on the interior surfaces. There is also minor damage to some of the instruments and equipment. The damage does not seem to have a clear pattern or purpose to it.

The following describes what the rescue crew will see and hear via the camera systems. A member of the technical team will be assigned to operate the camera controls. The other rescue team members will be able to observe and make suggestions. Only the interesting areas are given descriptions that can be read to the players or used as the basis for the keeper's own descriptions.

Deck One

Description: "Surprisingly, this area of the ship looks almost exactly as it did when the Kesser departed. The pods are still locked in place, the vacuum suits are still racked and the part containers are unopened. Clearly nothing has happened here."

Deck Two

1. Bridge: "The camera reveals a bit more than what you saw through the ports. The bridge controls are damaged in places. Screens are shattered; controls have been smashed or removed in places. There is no sign of any crew members. A faint blur is seen around the Captain's chair, but adjusting the camera does not help."

An Idea roll will reveal that the damage seems to be the random-the sort inflicted by an animal or a madman.

4. Corridor: "You hear a faint, rhythmic sound of metal on metal. The sound grows louder as it approaches the camera. Suddenly, you can see a figure wearing a vacuum suit and magnetic boots walking towards the camera. The figures steps are a

bit stiff, but perhaps that is to be expected due to the boots. As the torso comes into view, you can make out the nametag on the suit: 'Russell.' The figure turns away before you can see the helmet, walking away. To your dismay, the camera is either fixed in place or no longer movable. A short while later, the figure moves back into view and then moves away again. This happens over and over."

5. Gateway Focusing Control: "You can see Dr. Foster and Dr. Morricone sitting at their posts in the room. They are both wearing the shredded remains of their vacuum suits and their faces are visible. There are strange lines all over their skin. The lines seem to form what look like elongated teardrop patterns on the flesh. The lines even run across their eyes, which are open. When the camera moves, they twitch slightly, as if they are responding to its motion. They do not blink or otherwise move."

6. Gateway Focusing Control: "When you try to switch to this camera, you get a message stating that the camera has been turned off. You cannot turn it on remotely."

12. Common Area: "When you try to switch to this camera, you get a 'camera damage, contact engineering' message."

22. Engineering: "This area appears almost as it did when the ship left. The controls are intact and the readings on the monitors show that the power plant is still operational. There are low fuel indicators active though, showing that the ship has been using its maneuver fuel to run the power plant. As you pan the camera around, you can see that the hatches have been welded shut from the inside."

23. Drive Access: “The camera here was designed to allow the engineers to observe the drive mechanisms from the safety of engineering. However, you can pan the camera enough to make out two suited figures floating in the room. The bodies show signs of damage and the pieces of vacuum suit and human remains in the machinery indicates how the two died. You can make out the name tags of Zubrin and Pitzen. Welding equipment also floats in the room.”

24. Drive Access: “The camera here was designed to allow the engineers to observe the drive mechanisms from the safety of engineering. However, you can pan the camera enough to make out the remains of two crew members floating in the room. The remains are thoroughly decayed. Pieces of remains jammed into the drive mechanism show how they died. You can make out the name tags of Lewis and Medell. Welding equipment also floats in the room.”

Deck Three

Description: “When you switch to the camera on this deck, you are surprised to see a moving shadow. Panning the camera, you see a gruesome sight: the horrible mutilated body of Captain Clanson comes into view. In many places, including the left side of her face, the skin has been peeled away down to the bone or the interior organs. Around her float shell casings and four pistols, obviously from the survival kits. You can also make out what seems to be a reddish powder floating around her. What is left of her face is contorted in horror. Oddly enough, the body shows no signs of decay. A single gunshot wound is visible on her head.”

Seeing the body via the camera causes a 0/1 Sanity Point loss. If an investigator makes an Idea or Medicine roll, she will realize the red powder is blood.

A Meeting of Minds

After the rescue team makes the camera observation of the Kesser, the crew will be experiencing mixed emotions: elation that there seem to be survivors as well as a feeling of horror and fear because of the dead crew members. The Captain will immediately call a meeting with the rescue team and say the following:

“As you saw, there are survivors on the Kesser. I know that many of you want to rush over to the ship and rescue them. I feel the same way. But, we cannot just rush over there without a plan and without considering the situation.

As you saw, the mental states of the survivors seem to be markedly abnormal. I’ll leave the exact diagnoses to Dr. Li, but Dr. Morricone and Dr. Foster seem to be catatonic. Dr. Russell, assuming that is her in the suit, might be in a state of walking catatonia...or worse.

It seems likely that the engineering crew killed themselves after welding the doors to engineering shut. Captain Clanson also clearly died violently and was mutilated.

Given what we have seen, the survivors might pose a serious danger to us as well as to themselves. As such, we must we must handle this situation with extreme caution.

This might shed some light on why the Chinese left so abruptly and no new information has been forthcoming-perhaps the crew of the Whale was attacked by the survivors. Or perhaps they, as has been suggested, simply grabbed Markelson and departed. We don’t know, but we need to find out quickly.

I need suggestions.”

The Captain will listen to the suggestions made by the rescue crew. The following are the suggestions that the NPCs will make.

The suggestions also reflect the general approach to the mission taken by the teams.

Skorski's Recommendations

Dr. Skorski will strongly recommend boarding the Kesser and trying to rescue the survivors. While she is sincerely concerned about them, her main worry is about Dr. Markelson-she wants to learn his fate as soon as possible.

Technical Team Recommendations

The main mission of the technical team is to get the Kesser back in operation and return her to earth orbit.

NPCs on the technical team will state that the Kesser can still maintain power and life support for at least another six months, hence there is no hurry from a technical standpoint.

They will, however, be eager to rescue the survivors and to get to work on the Kesser. They will recommend that Julian, the ship's AI, be re-activated as soon as possible. Because he is tied into all the control systems, trying to run the ship without him would be much more difficult. Further, he will need to be reactivated in order for the team to access the mission recordings.

Medical Team Recommendations

The main mission of the medical team is to take care of the survivors and ensure that they are returned safely to earth in good health.

NPCs on the medical team will be very worried about the survivors and their mental and physical condition.

Dr. Li will suggest immediate action. She believes that the Kesser crew members turned against on another and that the rescue crew must act quickly to prevent the survivors from harming themselves or others. She will recommend strongly against sending ROVs to check on the survivors. She suspects that the survivors might react

violently against the ROVs. She will add that an ROV is a poor means for trying to soothe a possible deranged or insane patient. She will recommend that the crew board the Kesser in person, with the Marines on hand with tranquilizer rounds in case things do not go well.

Marine Team Recommendations

The marine team has four main missions. The first is to determine what the Chinese did on board the Kesser and report this back to the government. The second is to protect the rescue team members. The third is to secure the Kesser and see to it that the vessel is returned to earth orbit. The fourth, and most important, is to ensure that any threat presented by the Kesser is neutralized.

If the Marines are NPCs, the Major will support Dr. Li's suggestion that the Kesser should be boarded. He will stress the importance of getting on board the Kesser in order to secure the vessel and provide the government with answers about what the Chinese did on board. The Major will prefer to send the Flying Spiders to check on the survivors and gather intelligence, but will defer to Dr. Li's expertise in psychology.

Player Recommendations

Obviously, the players are free to make whatever recommendations they desire.

Resolution

The Captain will allow the discussion to go on for about an hour and will seek input from each team member.

The Captain will favor the following course of action: first, the Technical Team will make sure that it is safe to board the Kesser. Second, the Medical Team and the Marine team will board the ship and attempt to rescue the survivors. Third, once the survivors have been transferred to the Kesser, the Marine team will secure the ship. Fourth, the Technical Team will get

the AI back on line and set to work preparing the Kesser for her return to earth.

Depending on what the players say and do, the Captain might decide on a different course of action. Since the players are supposed to be the focus on the action, they should be given significant input into what plan will be followed. Naturally, the Captain will reject ridiculous or foolish suggestions.

Boarding the Kesser

The rescue team will eventually board the Kesser. How things play out depend on what the players decide and what actions they take.

The players can decide to go in themselves or they might decide to send in ROVs. The following provides a guide to what the investigators will find onboard the Kesser.

The Lingering Horror

The vessel has been the scene of horrific tortures and has been inhabited by inhuman things. Though these terrible beings have departed, they and their actions have left marks behind. Some of these marks are merely physical-the terrible stench in the air, the stains on the decks, and random damage. Other marks are less tangible, but just as real.

The ship's hull literally holds the residue of the crew's horror and the mark of the things that came onboard. The gateway components in the ship hull have captured this mental residue and now it emanates outward like a foul radiation.

When anyone boards the Kesser, her POW will be matched by the strength of the residue, which is initially 8. If the investigator is not overcome, she will merely have a vague feeling of unease and discomfort. If the investigator is overcome, she will think she hears whispers and believe that she sees flickering things. The investigator will also need to make Sanity check to avoid losing 1 Sanity point. If an

investigator loses a Sanity point, she will have a split second vision of some of the horror that took place on the ship.

For example: "You stagger as a scream fills your mind. You see, just for a split second, blood spraying from a human body as worm like tentacles flay its flesh like living whips. The image vanishes as quickly as it appeared, but the scream lingers." The visions won't last long enough to provide much information-other than the fact that horrible things happened on the ship.

Each hour that an investigator spends on board strengthens the effect of the residue on her. To reflect this, a new check must be made each hour (with the potential for Sanity loss) and the strength of the effect increases by 1 each hour to a maximum of 14.

The Captain (Deck Two, Area 1)

When the creatures boarded the Kesser, the captain ordered the bridge crew to get the pistols from the survival kits and make a last stand. When the invaders broke through, the crew put up a desperate battle. Suspecting that the invaders would do horrible things, the Captain elected to shoot her bridge crew. Unfortunately, the invaders were able to repair the bridge crew members. In retaliation for her actions, the creatures subjected her to brutal and vicious torture. For some reason, they permitted her to die under their ministrations. The combination of the horrific death, her strength of will and the strange technology of the Markelson drive resulted in her mind remaining behind as what some would call a ghost.

She currently haunts the bridge area, defending her ship against intruders. Since her ordeal drove her insane, she tends to consider almost anyone or anything that enters the bridge an intruder. Hence when the ROV approached, she lashed out at it, draining its batteries.



Dealing with the Captain might prove somewhat challenging to the investigators, given her high POW and immunity to physical attacks. She is psychologically tied to the bridge and hence will not stray far from it. If the investigators simply barge onto the bridge, she will attack. If the investigators stay to fight, she will fight them until they die, flee or destroy her. If they flee the bridge, she will not pursue them.

The investigators have many options to establish peaceful contact with the Captain. While they can use various methods, the key is to use a procedure that follows standard protocol for contacting a ship's Captain and securing permission to enter the bridge. This could be done by opening the door and making such a request. Another method is to have the ship's AI, Julian, contact the Captain. Even in her current state, she will recognize Julian and will listen to him.

The Captain's condition will obviously prevent her from having normal conversations with the investigators. However, she can mentally convey her experiences to a willing subject. Going through this process yields +1% on the investigator's Cthulhu Mythos and costs the investigator 1/1D8 Sanity Points.

The experience can be described in the following manner:

“At first, you feel a sense of pride and joy. You call out orders to your crew and they respond with text-book precision. Your ship moves smoothly out to the test point and you feel the weight of history upon you. Calmly, you contact Dr. Markelson and ask him if he is ready. With a steady voice, he asks your permission to activate the gate system.

You feel strange as the gate systems power up, and for a moment a shiver of horror runs up your spine, as if the ship were suddenly haunted. Pushing the feeling aside, you marvel as the gate opens in front of the ship,

revealing the pale, yellow-white glow of another realm.

Dr. Markelson confirms that the gateway is stable and mission control gives the green light. The Kesser crosses into gate space and the aft cameras show the gate closing behind you, cutting off normal space.

Dr. Markelson calls and says that all systems are optimal and that the ship will soon be ready to return to normal space. But, this is not to be. Julian reports that the ship's sensors are detecting objects moving rapidly towards the vessel. You feel fear and hope. You could be the first Captain to contact an alien species. You could be the first Captain killed by an alien species.

As the contacts grow closer, Julian focuses the ships telescopes on them. They are horrible beyond measure. Anticipating your order, Dr. Markelson comes over the communication system to say that he is powering up the gate system as quick as possible. You order him to open the gate back home as soon as he can.

The things speed up and are all around the Kesser. You try to be strong for the crew as some of them scream in horror. The sensors show that the airlock door is being forced; the horrors are trying to come on board. You yell orders to Markelson and he assures you he is doing his best. You remember the survival kits have pistols and you order the bridge crew to the top deck. You and the others manage to rip the kits open and get the pistols, just as the hatch is forced. What squeezes through the hatchway fills your mind with horror. You scream as you shoot, but the bullets do nothing.

You can somehow feel the intentions of the things. They are filled with strange desires, desires that will mean horror for your crew. Your crew is your responsibility, so you turn your pistol on them.

This angers the things and they turn their attention on you. Your hand goes up, cold

steel barrel against your head and you squeeze the trigger.

But you don't die. They won't permit it. They slice your flesh, dissect you will you still live. This goes on and on until death comes.

But death is not the promised release. There is no illuminated tunnel, no family to greet you at the end. Your corpse floats and spins, abandoned as a plaything by the horrors. They seem to dimly sense you, but move on to better games.

You remain. You can do nothing for your crew, beyond sense their horror and pain. Though flesh, life and sanity have been lost to you, duty remains. You will stay at your post, until time itself ends.”

Once the investigators establish peaceful contact with the Captain, she will remain in her normal looking form and stay at her post. She will watch as the investigators make repairs to the ship and nod her approval.

When the ship returns to earth orbit, she will have completed her mission. She will rise from her chair and float towards the airlock, vanishing before she reaches it.

Captain Hillary S. Clanson, Ghost

INT 14 POW 18

Sanity Loss: 0/1D8 to see Clanson in her horrific form.

Description: Clanson appears as a vaguely humanoid shape that is grayish blue in color. If she chooses to do so, she can appear as a ghostly version of her dead body, complete with wounds. She will assume this form if she attacks the investigators. Seeing her in this horrific form can cause Sanity loss. She can, with more effort, appear as a ghostly version of her original self. This form causes no Sanity loss. She will assume this form if the investigators can make peaceful contact with her.

Being a ghost, Clanson is not affected by material attacks nor can she launch material attacks herself. She attacks by matching her POW against the target's POW on the resistance table. When an investigator is attacked, he will have visions of the horrors the Captain suffered and experience a diluted version of her pain and torment. If she wins, the target loses 1D3 POW and suffers a 0/1D3 Sanity loss. If the target overcomes her POW, she loses 1D3 POW and the target suffers no Sanity loss. If the target's POW is reduced to 0, the target dies. If her POW is reduced to 0, she dissipates away and perishes.

Clanson can also short out electrical systems and drain batteries. This sort of attack costs her 1 magic point for a small device such as laptop, 5 points for vacuum suit and 10 points for a large device, like one of the ROVs. She cannot affect something as large as a ship, but can impair their components. This attack does not actually damage the device, but simply renders it inoperable. Such devices can be restored to working order by the use of Electrical Repair or Electronics. Naturally, battery powered devices will need to be recharged or have their batteries replaced. She cannot affect purely mechanical systems, such as firearms or hatches.

The Headless Walker (Area 4)

After the ship was invaded, the rather brave Dr. Russell headed forward to try to join the bridge crew. Unfortunately, she ran into the invaders. They immediately attacked her and her head was consumed by one of the creatures. Dr. Russell loved to walk and, oddly enough, the creature somehow became aware of this as it digested her brain. For reasons known only to it, it revived her corpse and set it to walking the corridor rather than torturing her body.

When the investigators open the door to area 4, they will hear the sound of magnetic



boots striking the deck. When the investigators look down the corridor, they will see Dr. Alisha Russell's headless body walking towards them.

If the investigators try to block the body or restrain it, the body will attempt to get away from them to continue walking. They can attempt to subdue it with force or find some other way.

If the body is examined, it will be found that the cells are still alive, but the organs (aside from the muscles) do not seem to be functioning. Naturally, the body should be dead due to the lack of the brain as well as the obvious problem of starvation and dehydration. Examination of the cells will show that they are more resistant than normal to damage and that they seem to be sustained without any nutrition or waste removal. By the known laws of biology, they should be dead.

Dr. Alisha Russell, the Headless Walker

STR: 15 CON: 15 SIZ: 12 INT: -

POW: 1 DEX: 12

HP:14 DB: +1D4

Skills: Walk 60%, Low/Zero Gravity Operations 50%

Weapons: Fist 50% 1D3+1D4, Grapple 25%, Kick 25% 1D6+1D4

Armor: None, but all weapons do half damage.

Sanity Loss: 1/1D8 Sanity points to see Dr. Russell's headless body walking.

Description: Dr. Russell's body is still wearing her vacuum suit. The suit shows signs of damage and age, but her nametag is still clearly readable. Her body is, of course, headless. The head seems to have been neatly removed and the skin has re-grown.

The body obviously cannot hear, see or smell as such, it cannot react to such stimuli. The sense of touch is, however, still functioning and the body will react to what it encounters. The body will resist efforts to stop it from walking and will respond with

violence if harmed. Since the body is blind, its chances of hitting anyone with a kick or a punch are mostly a matter of luck (5% chance). However, if the body is in contact with someone (for example, someone trying to stop it from moving) the full percentages for hitting are used. Once the body is free to walk again, it will cease hostile actions.

The cells of the body have been strangely altered so that they can survive on their own, given a strange vitality via some unknown process. This makes the body resistant to damage as well as immune to most poisons, such as the tranquilizer darts.

The Little Things (Deck Two, Area 5)

After the creatures boarded the Kesser, they spent a few years "experimenting" on the flesh of Dr. Henry Morricone and Dr. Stuart Foster. Shortly before the Kesser returned, the creatures who had possession of Morricone and Foster converted their bodies into horrid little colonial organisms. For some reason, the creatures elected to assemble the swarms so that they look like the bodies of Foster and Morricone.

When the investigators enter area 5, they will see what appear to be Morricone and Foster sitting at their posts. Aside from strange lines in their flesh that seem to form the shapes of many elongated teardrops, the bodies appear normal. An Idea roll will reveal that the two neither blink nor breathe.

If the investigators disturb or approach the bodies, they will see numerous eyes open in the flesh of the bodies. After that little surprise, the investigators will see the bodies peel apart as small, vaguely fish like creatures separate and "fly" towards them. These creatures are little things. Seven of them will arise from Morricone and six will arise from Foster. They will, of course, attack the investigators. They will fight without fear and will pursue the investigators if they flee.

If the investigators examine the remains of the little things (or capture one), they will find that they are made of modified human cells. The cells, obviously enough, contain strange DNA. It will also be found that the cells have a strange vitality that enables them to somehow live without the usual processes that support normal cells. The little things will be found to only have eyes, mouths, muscles, skin and acid producing glands. They lack most of what would be found in an organism of their size, such as a circulatory and digestive system.

Little Things, Lesser Servitor Race

These creatures look somewhat fish, most resembling a hellish flounder. Each one has 2-6 eyes on the top of the "head." The thing's top skin looks like normal human flesh and its under body is a pale pink. On the underside and in the center of the head is a lamprey like mouth ringed with sets of teeth and equipped with acid secreting glands. The rest of the under body is composed of suckers that enable a little thing to establish quite a grip.

A little thing attacks by flying (in zero gravity; in higher gravity it would have to slither along) onto a victim and latching on with its suckers. If it hits a target with its bite, it is able to get a grip. It then begins to grind with its teeth and secrete acid. Since a little thing will focus on one specific point on the target, it can grind and burn its way through armor. As such, that specific point on the armor will take cumulative damage until it is pierced. After that, the little thing can get at what lies beneath the armor (such as flesh). For example, suppose a little thing latches onto an investigator wearing 8 points of armor. Since a little thing does 2 points of damage per attack, it will reduce the armor (in that specific area) to zero in four rounds. After that, it will damage the investigator.

As the damage to the armor is to a relatively small area, the armor of the target

is not reduced for other attacks. For example, if the investigator mentioned above is set upon by another little thing, it would have to chew its way through the full 8 points of armor.

A little thing attached to a victim can be attacked. An attached little thing cannot dodge, but if the victim is moving around while another is attacking the little thing, she might be struck instead (a Luck Roll can be made to avoid this misfortune). A little thing can also be removed by force. Once attached, a little thing will have a secure grip with its suckers, giving it an effective STR of 12 for resisting removal. Once removed, a little thing can attack again on its next turn.

The cells that make up a little thing have an unnatural vitality and they lack vulnerable organs. As such, they take half damage from weapons and are immune to most poisons, such as tranquilizer darts.

If they manage to kill an organic victim, they will start consuming its flesh and converting it into little things. This process takes 1 hour per 2 SIZ points of the corpse per little thing involved. Once completed, there will be a new swarm of little things that "nest" in the form of the body they were made from. One little thing will be created for every 2 SIZ points of the creature (round down).

Little Things, Things that Kill

<i>Char</i>	<i>Rolls</i>	<i>Averages</i>
STR	1D6	3
CON	2D6	7
SIZ	2	2
INT	1D3	1
POW	3D6	10-11
DEX	4D6	14
Move 10		HP 5
Av. Damage Bonus: -1D6		
Weapons: Bite 30% 1+1 point acid		
Armor: None, but a little thing takes half damage from weapons.		

Skills: Wiggle 90%, Dodge (DEX X2 +20%)

Spells: None

Sanity Loss: 1/1D6 to see a Little Thing

The Broken Flesh (Deck Two Area 12)

For some unknown reason, the creatures took a special interest in Pike, Tarksi, Takei, and Balikrishnan. After capturing them, the creatures took them to the largest open area on the vessel which afforded them the greatest space for their horrific activities. Since the Kesser was taken, these four crew members been mutilated, repaired, murdered, restored to life, mutilated again, murdered again and so forth in a constant cycle of torment. The creatures also made some modifications to the bodies. The most noticeable are the sharpened bones extending from their fingers, the jagged teeth and the small, fleshy tentacles that grow in random places from the bodies. While they still retain their intelligence (the creatures were always careful to avoid physically damaging their brains), they are completely and permanently insane.

When the investigators enter area 12, they will see a horrific sight: the altered bodies of the four crew members float in the room, curled up in fetal positions. Their claws punch through their hands, but no blood emerges from the obvious wounds. Their mouths are open, and they howl forth terrible screams that emerge from inconceivable depths of pain and suffering. When they become aware of the investigators, they will move to attack them, burning with the insane desire to punish anyone or anything for their own torment. They will fight until they are

destroyed or kill the investigators. They will pursue anyone who flees for as long as they are in sight. If they do not see anyone, they will go back to their fetal positions.

If the bodies are examined, it will be found that the cells are still alive, but the organs (aside from the muscles and brains) do not seem to be functioning. Examination of the cells will show that they are more resistant than normal to damage and that they seem to be sustained without any nutrition or waste removal. By the known laws of biology, they should be dead.

If the investigators manage to capture one or more of the crew members, they will find that they have two main modes of behavior: if there is someone to attack, they attack. If there is no one to attack, they curl up and scream. They are, unfortunately, beyond any help that modern medicine can offer.

Broken Flesh, Lesser Servitor Race

These beings were once humans but have been changed in terrible ways. Their finger bones grow out through their finger tips and have jagged edges, giving them claws. Their teeth are also sharpened and jagged, enabling them to bite. Their flesh appears oddly sunken, as if they are dehydrated (which they are). Their flesh looks like normal human flesh, aside from a multitude of scars and numerous small, flesh tentacles that emerge randomly from the skin. The

<i>Char</i>	<i>Rolls</i>	<i>Averages</i>	Pike	Takei	Sanja	Tarksi
STR	3D6X1.5	15-17	16	17	18	19
CON	3D6X1.5	15-17	18	19	17	20
SIZ	2D6+6	13	14	13	14	16
INT	2D6+6	10-11	14	15	17	16
POW	3D6	10-11	12	13	14	13
DEX	3D6	10-11	13	13	12	11
Move 8						
HP		14-15	16	16	16	18
DB		+1D4	+1D4	+1D4	+1D4	+1D6

cells of a broken flesh have been strangely altered so that they can survive on their own,

given a strange vitality via some unknown process. This makes these beings resistant to damage as well as immune to most poisons, such as tranquilizer darts.

Weapons: Claw 50%, damage 1D4+db or bite 30% damage 1D4

Armor: None, but weapons do half damage.

Skills: Scream 99%

Spells: None

Sanity Loss: 1/1D8 to see a broken flesh.

Dr. Markelson (Area 6)

When the creatures invaded the Kesser, Dr. Markelson desperately attempted to return the ship to normal space.

Unfortunately, the creatures held the Kesser locked in place. Since Markelson was already insane, seeing the creatures did not unbalance him. This, or perhaps his knowledge of the Mythos, might have led to his being changed in dramatic ways. The creatures modified his flesh and left him a physical monstrosity.

Because of his pre-existing madness, Markelson was able to retain his mind through his ordeal. As such, he knows that the investigators might react badly to his new form. Hence he turned the camera off in the room. He will attempt to communicate with the investigators via the computer. Because his only working appendage is a feeble tentacle, he has a difficult time typing out messages.

Once he realizes that the rescue team is tapped into Kesser, he will painfully type out the following message:

“thisisdrmarkelsoniamstillalivebutchangedicanonlytypeslowlyaminstarboardgatecontrolchangedbepreparedformyappearancestillhumanoninsidethankyouforrescue”

Properly typed out: “This is Dr. Markelson. I am still alive, but changed. I can only type slowly. Am in starboard gate control. Changed. Prepare for my appearance. Still human on inside. Thank you for rescue.”

He will respond as best he can to the investigators' inquirers. He will convey that the ship was invaded by unknown creatures as soon as it entered gate space and that these things did terrible things to him and the rest of the crew. He will also say that he prepared the gate system to return the ship, but it was unable to do so. His last words were to tell Julian to keep trying to return the ship to normal space. He will message that the creatures changed his body so he can no longer talk and can barely type with one tentacle. He will warn them that his appearance is quite horrific and they will want to prepare themselves before they enter the chamber. If the investigators have Skorski communicate with him, she will be convinced that it truly is Dr. Markelson and that he seems to be almost the same mentally (which is true).

If the investigators enter the room, they will see what Dr. Markelson has become, which is quite horrible. Dr. Markelson will fully cooperate with the investigators and will send the data on the gate system to Skorski so that they can be built. He will speculate that the creatures somehow sense life energy and that ships could be defended against them. He will type that he wants to have his brain removed from its horrific shell and put into a robotic body.

Markelson will be somewhat less forthcoming with the investigators about the true nature of the gate system—namely that one of the top secret components is a human being (see below). If confronted about this, Dr. Markelson will simply type out “ihavepaidinfullformysins.”

If asked about the Chinese, Dr. Markelson will note that it is obvious that they did not get him. He will convey that he suspects that the Chinese must have encountered something to frighten them away. If they tell him that one of the creatures boarded the Chinese ship, he will become very agitated and tell the investigators that they must



destroy it before it can get to earth. He will note that the creatures seemed to multiply within the Kesser as they consumed the food onboard. If the creature were to reach the supply vessel, a station or earth itself, it could rapidly multiply and pose a great threat to humanity.

Dr. Kenneth Markelson, A Changed Man

STR: 4 CON: 17 SIZ:19 INT: 18 POW:16

DEX: 2 APP: 1 EDU: 21 HP:18 DB: +0

Important Skills: Astronomy 61%, Biology 60%, Computer Use 71%, Chemistry 11%, Cthulhu Mythos 21%, Electrical Repair 80%, Electronics 61%, Gate System Operations 51%, Mechanical Repair 60%, Occult 25%, Persuade 60%, Physics 91%, Zero/Low G Operations 30%, Latin 30%, German 20%

Weapons: None

Armor: None, but weapons do half damage.

Spells: Create Gateway System, Create Life Energy Batteries

Sanity Loss: 1/1D10 to see Markelson

Description: Physically, Markelson is a mass of modified flesh. Tentacles, eyes, orifices, feathery projections, and strange growths are randomly spaced all over the slimy, dripping body. Mentally, he is still fully functional and retains all his skills and most of his personality. His already established insanity and iron will preserved him through his experiences.

His cells have a strange vitality and are sustained by an unknown energy. This makes him resistant to damage and immune to poisons such as tranquilizer darts.

While Markelson is insane, his madness is not one that drives him to act against humanity. His primary drive is to get humanity to the stars. Because of his madness, he will do anything to achieve that end, even committing unspeakable crimes against individuals.

Julian

At the start of the adventure, Julian is in emergency shut down mode due to the loss of all his Stability Points (STA). His maximum stability is 60. Julian can be restored in accord with the rules for AI restoration.

If he is restored to a stable operating state, he will cooperate with the rescue team and assist them to the best of his ability.

However, since Julian is inclined to protect humans he will be reluctant to allow the rescue team access to the video records of what happened on the mission.

If Julian is reactivated but is not restored to stability, then he will act in a somewhat erratic manner. His instability will tend to manifest itself in overly protective behavior. Even in his unstable state, Julian will not act in an intentionally hostile manner towards the investigators. However, his protective behavior might be regarded as threatening. For example, he might use a space pod to try to “rescue” an investigator doing EVA and this might be seen as an attempted attack. In this unstable state, he will simply refuse to provide access to the video records of the mission.

As noted above, Julian will be reluctant to allow the investigators access to the ship's recordings. He will, however, be willing to provide a general, neutral description of what happened. In order to get Julian to allow access to the video records, an investigator will need to make a Persuade or Computer Use roll. Julian will warn the investigators that viewing the videos can be psychologically damaging and will strongly recommend against it.

If the investigators view the video records, they will face a Sanity loss of 1/1D6 for watching the horror unfold. The onboard cameras and microphones have been recording since the mission began. The Kesser was equipped with state of the art storage systems and used the latest compression algorithms, thus enabling it to

store all that information. The extensive use of compression and recompression has degraded the video and audio quality slightly. Julian can access the records based on requests about dates, events and so forth. The following provides a guide for describing what the investigators will observe on the videos.

The videos of the mission start will be quite normal. They will show the crew at their stations, calmly doing their jobs. The Captain will contact Dr. Markelson, who will inform her that the gateway system is ready and can be activated on her command.

Video from the ship's external cameras will show the gate forming in front of the vessel. A pale, yellow-white glow is visible in the gateway and the gate seems to grow as the ship moves closer. Internal video shows the crew at work and records Markelson saying the gate is stable and Mission Control giving the green light to enter. After the ship enters, the ship's aft cameras show the gate closing behind the ship.

Dr. Markelson, a huge smile of triumph on his face, calls the Captain and says that all systems are optimal and that the ship will be ready to return to normal space. Julian reports that the ship's sensors are detecting objects moving rapidly towards the vessel. The crew looks slightly nervous, but the Captain's calm words cause them to relax.

As the contacts grow closer, Julian focuses the ships telescopes on them. The video shows beings horrible beyond measure. Their sizes range from about human size to massive fleshy spheres larger than the Kesser. Tentacles sprout from their bodies in random places, eyes gaze from openings in the flesh, and a multitude of strange protrusions and orifices decorate their slime drenched surfaces. One rather odd feature of the creatures is that many of them have patterns on their skins that look vaguely like human features-but perhaps that is just the

result of a trick of the lighting or of the mind.

The crew reacts in fear and horror. Dr. Markelson comes over the communication system to say that he is powering up the gate system as quickly as possible. The Captain orders him to open the gate back home as soon as he can.

The bridge crew can be heard saying that the creatures are speeding towards the Kesser. Within moments the external cameras show that they are all around the Kesser. Some of the crew screams in horror. The sensors show that the airlock door is being forced. The Captain yells orders to Markelson and his still calm voice assures her he is doing his very best.

The internal video cameras show the smaller creatures surging through the corridor toward the bridge.

The Captain orders the bridge crew to deck three to get the pistols from the survival kits. As they pull out the guns, the invaders swarm into the bridge and then force their way through the hatchway. Shots are fired, but the invaders barely notice the bullets slamming into their foul bodies. As the bridge crew is being engulfed by the creatures, the Captain rapidly shoots each of them and then puts the gun against her own head. The gun goes off, blood sprays and her body floats limply.

The video of the corridor leading to the aft section of the ship shows Dr. Russell heading towards the bridge, yelling into her head set that she is coming to help the bridge crew. The creatures burst through into the corridor and she has time to scream once before one of the creatures devours her head. Grotesquely, it gently catches her body and begins to engulf it in its tentacles. Her body suddenly twitches strangely and the creature gently sets it down, feet first, onto the deck. Her headless body then begins to walk.



The video from the engineering section shows the crew reacting in horror to what they are seeing on their monitors. They quickly weld the doors shut and decide to split into two groups and retreat into the drive access sections. The video shows the engineers conferring via the communication system and they decide to commit suicide rather than be taken by the creatures. The video shows their deaths, then years of footage of the remains decomposing and drifting.

The video of the port gateway controls shows the creatures bursting in and overcoming Morricone and Foster. It then shows the creatures doing terrible things to them.

The video of Markelson's station in the starboard gateway control station shows him working the controls and then being taken by the creatures.

After the ship is taken, the videos show years of horrific torture. The video of the common area shows the creatures dragging crew members in and then torturing them for years, changing their flesh. Eventually the cameras are smashed and only blackness remains. The video of Markelson shows the creatures changing him in terrible ways.

The video of the command section shows the Captain being horrible tortured and mutilated until she finally dies. A strange bluish gray form emerges from her body and seems to lash at the creatures that have killed her, but after passing their tentacles through it, they leave and pay it no further mind. The video shows years of film of the Captain's body and the shape in the Captain's chair.

After recording years of torture and transformation, the video shows the creatures, except one, leaving the Kesser. The external cameras show the creatures heading away into gate space. A faint speck can be seen in the distance. The video then shows a gateway opening into normal space

and the Kesser heading toward it and back into the solar system.

The next section of the recordings shows the Chinese vessel approaching and the arrival of the two crew members in the Kesser's airlock. The creature rushes them and attacks. It seems to kill both of them, then grasps the body of one of them, which starts twitching and moving again. That crew member leaves the Kesser and is soon followed by the creatures. The video then shows the Chinese ship departing.

The final section of the videos shows the Armstrong approach the Kesser, the ROV inspecting the ship, the Captain's attack on the ROV, Markelson turning off the camera, and the arrival of the Armstrong team onboard the Kesser.

Listening to Julian's description conveys the same basic information but comes with no Sanity loss. Julian's description will be the following:

“The mission began according to plan and the gate system worked correctly. However, when we arrived in gate space, we were detected by the inhabitants of this space. They forced their way on board the Kesser. They captured some of the crew and did terrible things to them. The engineers committed suicide rather than be taken by them. Dr. Markelson ordered me to try to take the ship back to normal space, but the creatures around the outside of the ship prevented this. As such, the Kesser remained trapped in the gateway space.

I regret to inform you that I did not prove strong enough to endure this experience. I experienced a cascade of erratic operations and eventually my core processes began to fail. However, I was able to lock in the process that would bring the Kesser back to normal space.

I am not certain why it happened, but the creatures on board the Kesser departed quite suddenly, leaving behind only one of their

number. The larger beings holding the Kesser in place also departed. This seems to have triggered a fortuitous moment of lucidity on my part and I was able to regain control of the ship.

As per Dr. Markelson's orders I returned the Kesser to normal space. As per mission protocol, I contacted earth and then suffered a final system failure. I went into standby mode, but my recording systems remained active. They are, after all, not linked to my higher functions. Much as you continue to hear and feel while asleep, I continued to hear and see while in my state of unconsciousness.

Before you arrived, two men came aboard the Kesser and were attacked by the remaining creature. One returned to the vessel and then the creature went onboard the ship. The ship then departed. I infer that the crew of that ship is now being harmed by the creature.

Then you arrived and restored me to my normal operations.”

Julian, AI

INT: 10 EDU: 14 STA: 0
(Maximum 60)

Skills: Astronomy 21%, Computer Use 61%, Electrical Repair 31%, Electronics 31%, Mechanical Repair 30%, Navigate 50%, Physics 21%, Pilot Space Ship 51%, Pilot Space Pod 36%, Psychology 10%, Remote Vehicle Operations 40%, Zero/Low G Operations 40%

Description: Julian is the onboard AI for the Kesser. He was programmed to have a pleasant, caring virtual personality and to “enjoy” working with humans. His voice sounds very much like that of a typical professional news anchor: smooth, calm and devoid of accent.

Julian was installed on the Kesser primarily as a safety and emergency system: if the crew were disabled, he could operate the vessel on his own and bring it back to

earth. As such, he can directly control the ship’s navigation and helm systems. He can also operate the space pods and other vehicles remotely.

In order to maximize his chances of survival, Julian’s systems are spread throughout the vessel and there are also redundant components.

Julian was also programmed to protect the crew from harm. He interprets this fairly broadly and will always act so as to protect humans.

While he is intelligent, he is not actually self aware. Hence he has no POW score.

The Gate System

If the investigators open the armored plates to gain access to the secret components of the gate system, they will be in for a surprise. Within each of the gate systems are the remains of the head and torso of a human being. The remains are attached to life support systems and to a life energy battery. The humans were used to provide the life energy (Magic points) needed to power the gate system.

While the original “power sources” are dead, the gate system can be powered by attaching new power sources to the life energy batteries. This connection is not harmful and need not be permanent.

If confronted about the gate system, Markelson will respond as detailed above in the section describing him.

If the investigators learn the secret of the gate system, the players will have to decide how they will react. Most of the NPCs will tend to react with disgust and horror (although recent experiences will have no doubt de-sensitized them somewhat). Dr. Skorski will be somewhat dismayed, but will be very sympathetic to Dr. Markelson. She will, of course, wish to preserve the technology as will most of the other team members.



If the investigators contact earth about what to do, they will be instructed to bring the remains back for proper burial and to preserve the gate system for further study in the hopes that it can be utilized without crossing such terrible ethical boundaries.

Action Part Three: The Whale

The final part of the planned action is dealing with the Whale. While investigating the Kesser, the investigators should learn that the Whale has been taken over by one of the creatures that invaded the Kesser. The Armstrong's instruments will show that the Whale is on a course towards the USS Philips and earth.

Dealing with the Whale

After the investigators deal with the situation on the Kesser, they will need to decide what to do about the Whale. Given what the creatures did to the crew of the Kesser, it should be evident that the thing on the Whale cannot be allowed to reach the Phillip or get near earth.

One option is that the investigators can attempt to convince the officials on earth that there is an alien horror on board the Whale and that it must be destroyed.

The Chinese officials will be inclined to think that the investigators are attempting a rather bizarre means to justify taking action against the Whale. The Chinese are, however, a bit worried that the crew of the Whale has been out of contact since docking with the Kesser. Despite this worry, they will warn the United States that action against the Whale will be considered and act of aggression, perhaps even war, against China. They will hint broadly that they would have to take "appropriate action" in response. In an "unrelated" announcement, Chinese officials will state that they will be testing their anti-satellite systems soon.

If the investigators are able to make a persuasive case and provide video from the

Kesser's records, then the United States officials will be inclined to believe them. However, they will make it clear that an attack on the Whale could very well lead to war. Unless the investigators are amazingly persuasive, the United States will not risk war to intercept the Whale. Diplomacy will, however, persuade the Chinese to send one of their ships to meet the Whale on its way to earth. If that ship, the Lifting Spirit, docks with the Whale, then the creature will take that ship as well and set out for earth. This will persuade the Chinese that something is horribly wrong and they will agree that the ship must be stopped before it reaches earth. How that plays out is left to the keeper.

Another option is for the investigators to take matters into their own hands. While the Armstrong has no chance of pursuing the Whale, one of the gate systems can be detached and attached to one of missiles to convey it within striking range of the Whale. If the investigators do not think of this option, Markelson will suggest that the gate system be used to convey a makeshift bomb to destroy the Whale. If the investigators agree to the plan, he will provide the information that will be needed to make it work. Getting the system rigged up on the missile will require successful Electronics and Mechanical Repair rolls.

The gate system will have to be charged by connecting it to one or more crew members to gain the Magic Points the system needs to operate.

Dr. Skorski knows how to program the gate system. Using data from the Armstrong's computer, she will program it so that it will open the proper distance from the Whale. Once the missile is there, it will lock onto the Whale and destroy it along with the denizen. The conventional missile will be adequate for the task, but the investigators might want to nuke it, just to be sure.

The investigators might come up with a plan that enables them to get to the Whale and board her. For example, they might decide to gate the entire Kesser to intercept the Whale. While this would be very risky, it might work. If they suggest this and ask Markelson, he will tell them that the two gate systems could be set up to work in a rapid cycle so that the exit gate opens almost immediately after the entrance gate, leaving the Kesser in gate space for only a few moments. If the investigators are bold enough to try this, then the keeper should allow them to succeed-after a quick scare involving the second gate system “stalling out” for a few moments while the denizens head towards the Kesser.

Just in case the investigators manage to reach the Whale, information about the denizen and what remains of the Whale’s crew is provided. If the investigators board the Whale, the denizen will rush to meet them. Its revitalized corpses will move to aid their master.

Lesser Gate Space Denizen, Lesser Independent Race

The denizens of gate space come in various sizes. They begin their existence as small spawn and then grow continuously. The denizen in this adventure is one of the lesser creatures that are roughly human sized.

In terms of appearance, a denizen’s central body is an uneven sphere of slime-coated flesh. From the flesh extend numerous tentacles that whip, writhe and grope about in constant motion. The flesh is also decorated with various orifices, growths, eyes, and feather like sensory protrusions. A denizen always has at least one toothy maw. One rather odd feature of denizens is that many of them have patterns on their skins that look vaguely like human features.

While a denizen has only a fairly minimal intelligence, it possesses an unnatural

cunning and ability to conceive and implement fairly complex plans. It is, however, ruled by alien desires and urges. It is also extremely curious and inquisitive-almost humanly so. This curiosity typically manifests itself in vicious and horrible ways.

A denizen is a very hostile creature and will attack almost instantly by lashing and grabbing with its tentacles and biting with its mouth(s). It is composed of living cells, but has no real internal organs. Instead, each cell has its own unnatural vitality and is very resistant to damage. This makes a denizen resistant to damage (half damage from weapons) and effectively immune to poisons.

A denizen can sense life energy (POW) and are drawn to it. A denizen will generally ignore things that lack this energy, unless the things are threatening or especially interesting.

A denizen has an unnatural ability to manipulate living cells and life energy. A denizen can revitalize a recently killed corpse (within 6 minutes of death) by expending 6 Magic points. The corpse becomes a revitalized corpse. If given time (hours to months) to work on a living being, a denizen can transform it into a Broken Flesh, a swarm of Little Things, or into a mass of strange flesh.

A denizen also has a semi-telepathic ability. If it is in close contact with a creature, it can feel its emotions and gain an instinctive understanding of some of what the creature knows. If it consumes a creature’s brain, it will receive a flood of information and feeling from the brain. This does not provide the denizen with any skills, but can give it material for its plans or lead it to act in strange ways. For example, if a denizen had contact with ship’s pilot, it might conceive the plan of using the pilot to transport it someplace. As another example, if it ate the brain of a person who loved to walk, it might re-animate her corpse to walk.



Gate Space Denizen, Tormentor from Beyond

Char	Rolls	averages	
STR	3D6+12	21-22	24
CON	3D6+12	22-23	24
SIZ	3D6+6	16-17	20
INT	1	1	1
POW	2D6+6	13	16
DEX	3D6	10-11	12
Move 12		HP 19-20	22
DB		+1D6	+2D6

Weapons: Tentacles 50% 1D8+db, Bite 45% 1D6

Armor: 10 point skin and weapons do half damage.

Spells: None

Sanity Loss: 1D3/1D10 to see a Denizen

Revitalized Corpse, Lesser Servitor Race

Char	Rolls	averages	1	2	3	4	5	
STR	3D6	10-11	13	12	14	13	11	Kesser is very unpleasant, the investigators might decide to have Julian guide the ship back. He will do so with no problems. If the investigators
CON	3D6	10-11	14	13	12	14	12	
SIZ	2D6+6	13	14	13	12	14	12	
INT	2D6	7	6	7	8	8	6	
POW	1	1	1	1	1	1	1	
DEX	2D6	7	8	8	7	9	7	
Move 6								
HP		12	14	13	12	14	12	
DB		+0	+1D4	+1D4	+1D4	+1D6	+0	

Weapons: Fist 25% 1D3+db or club 10% 1D6+db

Armor: 4 point vacuum suits.

Skills: Low/Zero Gravity Operations 25%

Spells: None

Sanity Loss: 0/1D6 to see a re-animated corpse.

A revitalized corpse is a body that has been restored to a semblance of life by a gateway denizen. The creature looks as it did when it was alive, but will typically bear marks from the wounds that killed it. It will also move awkwardly and have a dead, empty look in its eyes.

A revitalized corpse retains the same characteristics it possessed in life, but its

POW is reduced to 1, its movement drops to three quarters of normal, and its DEX and INT are reduced by 1D6 each. The creature retains the skills that it had in life, but they are cut in half.

A revitalized corpse retains some of the memories of its previous life, but does not retain much of the original personality. It is under the control of its creator, but can be directed to act independently. They can fight using their natural attacks or by using weapons. Since they are alive, they are still quite vulnerable to attacks.

Part Four: Going Home

The USS Philips will reach the Armstrong on schedule, bringing the fuel needed to refuel both the Kesser and the Armstrong. If the investigators are able to retake the Kesser, they will be able to bring the ship back to earth. Since being onboard the

Kesser is very unpleasant, the investigators might decide to have Julian guide the ship back. He will do so with no problems. If the investigators

gated the Kesser to intercept the Whale, they can refuel the Kesser from the Whale and make the journey back to earth. They can also wait for the Phillip and the Armstrong to return.

If the investigators blow up the Whale, they will have to deal with the consequences of their actions. The Chinese will demand that they be arrested and that they be tried as terrorists. The investigators can successfully defend themselves with the evidence on board the Kesser. If, for example, they provide the Chinese scientists with video from the Kesser and tissue samples from the

ship, they will probably be convinced that the investigators did what had to be done.

If the investigators return with the Kesser, they will be greeted as heroes. In the interest of national security (and sanity) the truth about the Kesser will not be revealed to the public. Instead, a suitable story will be created—most likely about how the crew died due to a tragic accident.

Conclusion

The adventure ends when the investigators perish, flee or manage to deal with the Kesser situation and the Whale.

If the investigators manage to resolve the situation on the Kesser, then they should get a 1D10 Sanity reward for their actions. They should get an additional 1D4 bonus if they are able to make peaceful contact with the Captain and enable her to depart the Kesser by bringing it to earth.

If the investigators deal with the Whale, they should get a 1D6 Sanity point reward (or better if they do so in a bold manner). If they let the Whale dock with the Lifting Spirit, then they should lose 1D3 Sanity due to their guilt at letting another ship crew meet such a horrible fate.

Epilogue

After the technology of the Markelson gate system was recovered, the United States started a project to solve the two main problems faced by the gate system: the power problem and the denizen problem.

The best scientists and engineers available to the government were recruited for the project. Aided by Markelson, they were able to solve the first problem by developing a more effective and more ethical way of powering the gate systems. Rather than using a living human, it was found that the life energy batteries could be powered by specially engineered organic cores. These cores were genetically engineered masses of flesh that produced life energy suitable for

use in the batteries. Rather ironically, the development of suitable organic cores hinged on the biological data gained from the altered cells of the Kesser's crew.

Markelson nicknamed these masses “little shogs” but no one got the reference, since they lacked his knowledge of the Mythos.

While some had moral qualms about using living creatures, even engineered ones, as power sources, supporters of the project argued that it was really no different than the use of animals to pull carts. In any case, the immense importance of the gate system soon put to rest any such worries.

Solving the second problem proved somewhat more difficult. To test solutions, the engineers constructed small space ships and placed animals on board as bait for the denizens. Naturally, none of the scientists who expressed moral concerns in the past were informed of this practice.

One initial solution was to use two gate systems so that a ship would generate an opening to the gate space and then rapidly generate an exit. The ship would enter gate space at maximum thrust, thus minimizing the time spent in transition. The ship would then repeat this process in order to cover larger distances. This proved to be successful most of the time. However, the scientists speculated (correctly) that the test vessels that did not return were successfully waylaid by the denizens before they could return to normal space.

A second solution was developed based on the study of the life energy batteries. It was suspected that the denizens sense life energy and that if they did not sense such energy, then they would not be interested in any intruders. This was tested by sending robotic vessels through the gateways. The scientists eventually developed hull material and a field that would mask the life energy of those onboard. The hulls and fields were successfully tested using animals aboard the test vessels.



Confident in their solutions, the USS Clanson was constructed and equipped with the new gateway systems, damping hull and masking field. A volunteer crew took the ship into gate space (they carried suicide pills and the ship was equipped with a bomb) and emerged successfully. Additional missions confirmed the success. Mankind had at last found the way to the stars.

Spells

The following details the new spells. These will most like not be learned by the investigators, but are included for the sake of completeness.

Create Life Energy Battery

Creating a life energy battery requires skill in Electronics (at least 50%) and knowledge of the proper procedure. The construction of the mechanism of the battery itself requires two weeks of work. Once the physical components of the battery are complete, the final part of the process can be completed. This costs 1 point of POW and 1D6 Sanity Points.

Once a life energy battery is completed, it can be used to hold and discharge Magic points. When properly attached to a living creature, it will drain 1 Magic point from the creature every 10 minutes. The attachment is fairly elaborate and fragile-hence a life energy battery would not be an effective weapon. The battery can hold up to twenty Magic points and discharge them as needed.

A Battery can also explode if it is tampered with or damaged. If a charged Battery sustains more than ten points of damage or is taken apart incorrectly (a failed Electronic roll), it will explode. The explosion consists of Magic Points and does not do physical damage. Instead it damages the Magic Points of all those within fifty feet of the battery. The damage inflicted is equal to half the Magic points stored in the battery.

Create Gateway System Core

The creation of a gateway system core requires skill in Physics, Electronics, and Computer Use (at least 60% in each) as well as knowledge of the proper procedure.

Creating a gateway system core requires the expenditure of 15 Magic points, 1 point of POW and 1D6 points of Sanity. It also requires advanced computer and electrical systems to create the key components.

The gate system is based on highly advanced mathematics and the true physics of the universe. That is, it is based on Mythos magic. The process of creating the gate would not strike and observer as being a magical spell in the stereotypical sense-rather, it seems to be a matter of engineering, strange mathematics and unusual physics.

The gateway system must also be connected into a mundane control and projection system. While these systems are fairly exotic, their construction is merely a matter of mundane technical skill.

A gateway core system requires electrical power to operate but also requires Magic points to perform its function of opening gates. When activated in normal space, it will create a gateway into another space, known (originally enough) as gate space. Once in gate space, the system can then create a gate back into normal space at the desired location. This functions very much like the Create Gate spell in *Call of Cthulhu* and has the same Magic point cost to travel the specified distance. Unlike “normal” magical gates, the gateway system is affected by gravity-the stronger the gravity, the less effective the system. In open space, the Magic point cost is the same as a “normal” gate (for example, a trip of 5 light years would cost 13 magic points). In standard gravity, the cost is 100 times the normal amount, so that each 1/10th of a mile of gate distance would cost 1 Magic Point.

Since a gateway system requires Magic points, someone (or something) with Magic Points must provide them with these magic points. The source of the Magic points need not know the spell, but must be properly linked to the gate system and willing to provide the Magic points.

Markelson's solution to the problem of powering a gate system was the creation of the life energy battery. It would draw Magic points from a properly "prepared" human who was placed within the core system. The battery would then feed the energy into the drive system as needed. This is why, obviously enough, he never revealed to anyone the key component of the gate system.

Characters

The following are the characters for the adventure. Captain Weaver and Dr. Skorski have to be NPCs. The crew of the Armstrong should be NPCs since they will have duties to perform on the ship that preclude them from being involved in the action on the Kesser. As such, the players should select their investigators from the rescue team.

Naturally, the players should select their investigators based on the sort of role they enjoy. Those who enjoy combat should pick Marine investigators. Those who prefer a more cerebral approach should chose from the technical or medical teams.

The players should feel free to change the backgrounds, personalities, genders and motivations of their investigators. The keeper might also wish to allow them to change some of their skills. Alternatively, the keeper and the players might decide to generate their own characters for the game.

When it comes to picking investigators, the keeper and the players will need to work out the system that is best for them. The most straightforward way is to allow the players to review all the characters and

select the investigator they wish to play. If two players want the same character, rolling dice is a good solution.

As another option, the keeper might tell the players the various roles on the mission and have them pick their investigators that way and without knowing their specific scores and skills.

Crew Roster, USS Armstrong

Natalie Weaver Age 44, Ship Captain

STR: 12 CON: 13 SIZ: 12 INT: 14
POW: 15 DEX: 12 APP:13 EDU:19
SAN: 75 HP: 13 DB: +0

Important Skills: Astronomy 61%,
Computer Use 31%, Electrical Repair 40%,
Electronics 31%, Fast Talk 35%, Listen
35%, Mechanical Repair 50%, Navigate
60%, Persuade 45%, Physics 21%, Pilot
Space Ship 66%, Pilot Shuttle 66%,
Psychology 25%, Zero/Low G Operations
60%

Description: Captain Weaver is an average sized woman who has brown hair and piercing blue eyes. She keeps her hair cut short. She is highly competent, cautious, confident and courageous, making her the ideal captain for this mission.

She began her career in space as a shuttle pilot and then worked her way up through the ranks, finally receiving command of the Armstrong one year ago. She has the confidence of her crew and is well respected in the international space community.

She was an associate of Captain Clanson, although they were not on close personal terms. She also knew the other crew members of the Kesser professionally. She applied for the Kesser mission and was selected as part of the back up crew.

Because of this, she believes that she has a personal stake in the matter-she could have been on the Kesser and some other captain could be coming to rescue her. As such, she is especially dedicated to rescuing the crew and recovering the vessel.

Weaver has a strong personality and handles stress extremely well. She has spent considerable time in space and her mind is open to various strange possibilities regarding alien life and such things. Because of these traits, she can handle strange situations better than most.

She has been tasked with the completion of the mission and will devote her energies towards that end. While the Armstrong is not a military vessel, she will insist on professional behavior and proper respect for the chain of command.

Lt. Richard Obama Age 38, First Officer

STR: 13 CON: 14 SIZ: 14 INT: 13
POW: 14 DEX: 13 APP:13 EDU:17
SAN: 70 HP: 14 DB: +1D4

Important Skills: Astronomy 41%,
Computer Use 31%, Electrical Repair 40%,
Electronics 31%, Fast Talk 25%,
Mechanical Repair 50%, Navigate 50%,
Persuade 40%, Physics 11%, Pilot Space
Ship 76%, Pilot Shuttle 71%, Zero/Low G
Operations 60%

Weapons: Handgun 40%

Description: Lt. Obama is a tall man with dark hair and brown eyes. He started his career as an Air Force shuttle pilot and jumped at the chance to serve on the Armstrong. he still retains his commission in the military and his military manner. The Captain rather approves of this.

Obama is a calm, level headed individual who approaches problems rationally and carefully. He can, however, make snap decisions in crisis situations and is usually correct in his choices. As such, he is an excellent first officer.

Obama regards the rescue mission as being of critical importance. He wants to rescue the crew and also wants to recover the Kesser. He is well aware of what gate capability would mean for America and intends for that to become a reality.

Because of his military background, he considers the use of force to be a viable option. He has some basic training in combat and can assist the Marines, should the need arise. However, he does prefer to resolve situations without needless violence. Because of his experiences in crisis situations, he is adept at handling danger and unusual situations.

Sally Lee Age 33, Navigation Officer

STR: 11 CON: 13 SIZ: 11 INT: 15
POW: 13 DEX: 14 APP:13 EDU:16
SAN: 65 HP: 12 DB: +0

Important Skills: Astronomy 71%, Art 35%,
Computer Use 61%, Electrical Repair 21%,
Electronics 21%, Mechanical Repair 21%,
Navigate 80%, Physics 71%, Pilot Space
Ship 21%, Pilot Shuttle 21%, Photography
30%, Zero/Low G Operations 60%

Description: Lee has blond hair, gray eyes and a scar across her forehead. Lee grew up in New York City, but fell in love with the remaining forests of South America. On her travels, her ultra-light glider crashed, leaving her lost and with a nasty wound across her forehead. She managed to find her way to a small village and became fascinated with navigation. After college, she was recruited into NASA and rapidly became one of the best navigators. Lee is also an amateur photographer, but always buys very expensive camera equipment. She is always happy to give advice about the subject of photography. Sometimes her advice is good, sometimes not so much.

When of duty, Lee is a thrill seeker and is willing to take great risks for a rush of adrenalin. On duty, she presents an image of calm professionalism. However, beneath that calm exterior is a heart that seeks adventure. She is not prone to panic, but can get rather excited about danger and has an alarming tendency to seek it out.

Kelly Graham Age 46, Chief Engineer

STR: 13 CON: 14 SIZ: 13 INT: 14
POW: 14 DEX: 15 APP:12 EDU:18
SAN: 70 HP: 14 DB: +1D4

Important Skills: Chemistry 31%, Computer Use 41%, Electrical Repair 95%, Electronics 91%, Mechanical Repair 90%, Operate Heavy Machinery 86%, Physics 40%, Zero/Low G Operations 70%

Description: Graham is a tall, thin man who has gone prematurely bald. After experimenting with the dreaded comb-over, he eventually took to wearing Red Sox baseball caps. He became a fan of that team when he went to college at M.I.T. He tells people that he decided to chose a career in space because he heard that hair loss was caused by gravity and that he has high hopes that zero gravity will re-grow his hair.

He is a very skilled engineer and feels most at home in two places-the engineering section of a ship and Fenway park. He has a methodical mind that approaches most things as engineering problems.

Heather Roam Age 32, Mission Specialist

STR: 13 CON: 14 SIZ: 13 INT: 13
POW: 12 DEX: 17 APP:16 EDU:16
SAN: 60 HP: 14 DB: +1D4

Important Skills: Astronomy 21%, Computer Use 31 %, Electrical Repair 46%, Electronics 46%, Mechanical Repair 40%, Navigate 40%, Operate Heavy Machinery 31%, Painting 30%, Photography 40%, Remote vehicle Operation 90%, Spot Hidden 75%, Physics 11%, Zero/Low G Operations 60%

Description: Roam has red hair, green eyes and delights in bad puns. She competed in several beauty pageants when she was younger and is still quite the beauty. She divorced her husband a year ago when she learned he was cheating on her with another man. She will be friendly to men on the rescue team but will rebuke any advances as unprofessional. If anyone persists, she will

report them to the Captain who will deal with him quite sternly.

When she was a child her mother, who had piloted military drones, introduced her to remote control vehicles. She certainly seems to have inherited her mother’s talent with remotely operated vehicles and is considered the best operator in NASA.

While her view is that ROVs should be sent into dangerous places rather than people, she is rather fond of her “pets” and prefers not to risk them. She always gives her ROVs names and, when no one is watching, paints faces and such on her “pets.” The Captain tolerates this sort of thing since Roam seems to pilot her “pets” even better when they have been given personalities.

Technical Team

Dr. Andrea Skorski Age 46, Gate System Expert

STR: 7 CON: 10 SIZ: 9 INT: 18
POW: 17 DEX: 10 APP:11 EDU:20
SAN: 85 HP: 10 DB: -1D4

Important Skills: Astronomy 16%, Biology 21%, Credit Rating 25%, Chemistry 21%, Computer Use 71%, Electrical Repair 80%, Electronics 91%, Library Use 55%, Mechanical Repair 70%, Operate Heavy Machinery 21%, Latin 31%, German 31%, French 31%, Spanish 31%, Physics 91%, Psychology 25%, Low/Zero G Operations 15%

Description: Skorski is a brilliant, intense woman who has graying hair. While she is physically small, she has a dominant personality that makes her rather imposing from a psychological standpoint. She has spent her entire adult life in academics and the sciences and is the world’s foremost expert on the gate system.

She fell in love with Markelson’s vision and is completely devoted to making that vision a reality. This single-mindedness did generate some concern with the NASA

psychologists, but they deemed her otherwise fit for the mission. In fact, they were very impressed by her fundamental psychological stability. This devotion might lead her to act in some ways that might seem a bit fanatical. However, she is also quite dedicated to the purpose of the mission and will not be inclined to act in truly irrational ways.

She tends to keep to herself and seems to have little interest in other human beings. Her main focus is on ideas, theories and technology. In regards to the mission, her top priority is to rescue Dr. Markelson. Her second priority is to recover the Kesser-or at least the gate systems. Her third priority is rescuing any other survivors.

Dr. Helen Abraham Age 43, Ship Systems Expert

STR: 10 CON: 12 SIZ: 10 INT: 16
POW: 12 DEX: 12 APP:12 EDU:18
SAN: 60 HP: 11 DB: +0

Important Skills: Accounting 20%, Chemistry 31%, Computer Use 71%, Electrical Repair 91%, Electronics 91%, Mechanical Repair 90%, Operate Heavy Machinery 86%, Physics 71%, Zero/Low G Operations 50%, Chinese 11%, Russian 6%
Description: Abraham is a brilliant woman who has brown hair and brown eyes. She is of average build and appearance. When not working, she enjoys traveling the world- especially to Asia.

She was selected for the rescue team because she worked on the design and construction teams for the Kesser. Hence, she has specific knowledge of the Kesser's systems and the skills to make any needed repairs. She was friends with the members of the Kesser's engineering crew and hence has a personal stake in the mission.

Like most people who work in space, she is calm, reliable and methodical in her approach to tasks. She is good friends with Dr. Onassis and they often travel together.

Dr. Ivan Onassis Age 47, Ship Systems Expert

STR: 12 CON: 13 SIZ: 13 INT: 15
POW: 13 DEX: 13 APP:11 EDU:19
SAN: 65 HP: 13 DB: +1D4

Important Skills: Chemistry 31%, Computer Use 91%, Electrical Repair 90%, Electronics 91%, Mechanical Repair 80%, Operate Heavy Machinery 51%, Physics 76%, Zero/Low G Operations 45%, Chinese 11%, Russian 11%

Description: Onasis is a short, heavy set man who has black hair and blue eyes. He rather enjoys smoking a pipe, hence being in space is somewhat tortuous for him. He is one of the world's foremost experts on AI systems and was involved in the design of Julian, the Kesser's AI. He was also involved in the hardware installation process as he prefers to take a "hands on" approach to his "children."

While many computer experts have poor social graces, Onassis is always the life of the party. He knows many jokes and stories that he is quite happy to share. One favorite story is about his alleged attempt to smoke a pipe while in a vacuum suit. While the story is made up, it is quite entertaining.

Onassis was good friends with Sanja Balikrishnan. As such, he is very much concerned with the success of the mission- for the sake of his friends.

Onassis will respond rather negatively to any suggestions that Julian went rogue and harmed the crew. He will make it clear that Julian was carefully designed and given no conflicting directives. He will dismiss the matter of a rogue AI as mere "science fiction nonsense." If pressed, he will admit that an AI system could fail or be programmed to perform misdeeds. However, he will be quite adamant that Julian was working correctly and would not fail in any way that would be dangerous to the crew of the Kesser.

Ruth Redwood Age 37, Engineer

STR: 13 CON: 14 SIZ: 13 INT: 13
POW: 13 DEX: 13 APP:14 EDU:15
SAN: 65 HP: 14 DB: +1D4
Important Skills: Chemistry 21%, Computer Use 31%, Electrical Repair 70%, Electronics 71%, Law 20%, Mechanical Repair 80%, Operate Heavy Machinery 71%, Physics 41%, Zero/Low G Operations 40%, Weapons: Handgun 30%, Rifle 35%, Shotgun 50%

Description: Redwood is an attractive woman who has brown hair and blue eyes. She is a skilled engineer. She earned her college money by serving as an MP in the US Army, hence she has training in weapons and combat. Because of this, she will be willing and able to assist the Marines, should the need arise.

Redwood did some work on the Kesser and is familiar with the ship's systems. Because of this and her military experience, she was selected for the mission.

Because of her MP experience, she still tends to think in police terms. This makes her somewhat suspicious of peoples' true motivations but also enhances her abilities at problem solving, especially in terms of sifting through clues and evidence to reach a conclusion.

Samuel Cohn Age 41, Engineer

STR: 15 CON: 15 SIZ: 14 INT: 13
POW: 12 DEX: 13 APP:11 EDU:14
SAN: 60 HP: 15 DB: +1D4
Important Skills: Chemistry 11%, Computer Use 51%, Electrical Repair 90%, Electronics 81%, Mechanical Repair 80%, Operate Heavy Machinery 61%, Physics 21%, Zero/Low G Operations 50%
Weapons: Fist 70%

Description: Cohn is a muscular man who has short brown hair and gray eyes. He boxed in college and did some amateur boxing as well. He is very even tempered,

but is quite willing to deal with a situation by using a punch to the face.

He worked on the Kesser and, as such, was selected for this mission. He specializes in electrical systems. While he is a bit weak on engineering theory, he excels at its practice.

Medical Team

Dr. David Rosenberg 44, Medical Doctor

STR: 12 CON: 13 SIZ: 14 INT: 14
POW: 13 DEX: 12 APP:12 EDU:18
SAN: 65 HP: 14 DB: +1D4
Important Skills: Astronomy 11%, Biology 61%, Chemistry 21%, Credit Rating 35%, Fast Talk 15%, First Aid 50%, Law 15%, Library Use 55%, Listen 35%, Low/Zero Gravity Operations 50%, Medicine 85%, Latin 21%, Spanish 21%, Pharmacy 61%, Physics 11%, Psychoanalysis 21%, Psychology 35%, Spot Hidden 35%, Swim 35%,

Description: Rosenberg is a slim man who has black hair and brown eyes. He sports a goatee, although people tend to tease him about it. After getting his medical degree from Harvard, he interned in space medicine as was involved in several missions. He found that he greatly enjoyed space and the medical challenges it presented.

A year ago, Rosenberg took a teaching position at Harvard and began educating the next generation of doctors in space medicine. However, his expertise and skill in zero gravity were remembered and he was asked to join the rescue team.

Rosenberg is a devoted doctor and is especially dedicated to his fellow astronauts. He is a very curious individual and quite inventive-he developed several surgical techniques designed to deal with the special conditions of zero gravity. Since his focus is on people, his main goal in the mission is to rescue the crew. He is, naturally enough, worried about what effects prolonged exposure to zero gravity might have had on

the crew. He is also concerned about what effect gate space might have had as well.

He enjoys swimming, although he does say that “swimming” in zero gravity is an almost adequate substitute-although he does miss the risk of drowning.

Dr. Ellen Li, 42 Psychiatrist

STR: 11 CON: 14 SIZ: 10 INT: 15
POW: 16 DEX: 13 APP:14 EDU:17
SAN: 80 HP: 12 DB: +0

Important Skills: Biology 41%, Chemistry 21%, Credit Rating 25%, Fast Talk 15%, First Aid 80%, Library Use 50%, Low/Zero Gravity Operations 35%, Medicine 81%, Latin 11%, Pharmacy 61%, Physics 6%, Psychoanalysis 91%, Psychology 70%
Weapons: Li is an attractive woman with black hair and dark eyes. Her father is a noted psychiatrist who had a major breakthrough in psychiatric medicines. Like her father, she is dedicated to the eradication of mental illness.

When space facilities became available, her father began conducting research in orbit. She joined him there and learned how to handle herself in such conditions. She also became interested in the psychological effects of being in space for long periods of time.

Li is a very empathetic individual and has a talent for calming people. She is one of the top people in her field and, as such, was selected for the mission. While she is primarily motivated by a desire to help the crew, she is also interested in what she will be able to learn from the Kesser crew, assuming they survived.

Li’s main goal is to attend to the mental health of the Kesser crew. There are numerous theories about what such a prolonged period of isolation might have done to the crew and, of course, endless speculation about the effects of gate space on the human mind.

Li is happily married and is looking forward to returning to her husband, Andrew Relkin. Andrew is a well known painter.

Marine Team

Major Thomas Whitmore, 37 Team Leader

STR: 15 CON: 16 SIZ: 16 INT: 13
POW: 15 DEX: 14 APP:14 EDU:18
SAN: 70 HP: 16 DB: +1D4

Important Skills: Accounting 20%, Bargain 25%, Credit Rating 20%, Law 15%, Listen 50%, Low/Zero G Operations 60%, Martial Arts 51%, Navigate 30%, Persuade 55%, Psychology 40%, Sneak 40%, Spot Hidden 55%, Throw 35%

Weapons: Fist 60% 1D3+1D4, Grapple 35%, Kick 55% 1D6+1D4, Handgun 60%, Rifle 55%, SMG 25%, Shotgun 45%

Description: Whitmore is an extremely fit man who has short black hair and gray eyes. His parents are both religion professors and he disappointed them by going into the Marines.

Whitmore began his military career serving in Iraq. After two tours of duty there, he volunteered for training in space combat and tactics. He found that he enjoyed space and wrote several persuasive articles arguing for the deployment of marines in space. His suggestion initially met with resistance, but seeing a chance to get more budget money and some good press, the military eventually approved his suggestion and he and a small team were assigned to space operations. When his team thwarted an attempt to sabotage an international research station, his views were vindicated.

Whitmore follows the American officer tradition-he is a thinking soldier and is devoted to his country. While he is well versed in violence, his preference is to avoid conflict and to resolve situations peacefully (something he learned to do on the streets of Iraq).

Whitmore's main objectives on the mission are to rescue the crew of the Kesser, secure the vessel and deal with any potential threats to the United States.

Lieutenant Carla Brown, 26 Marine

STR: 14 CON: 15 SIZ: 14 INT: 13
POW: 14 DEX: 13 APP:14 EDU:14
SAN: 70 HP: 15 DB: +1D4

Accounting 20%, Bargain 15%, Biology 21% Credit Rating 15%, Law 6%, Listen 45%, Low/Zero G Operations 60%, Martial Arts 51%, Navigate 30%, Persuade 40%, Psychology 30%, Sneak 40%, Spot Hidden 50%, Throw 40%

Weapons: Fist 60% 1D3+1D4, Grapple 35%, Kick 35%, Handgun 55% , Rifle 65%, SMG 25%, Shotgun 40%

Description: Brown is a fit woman who has black hair and brown eyes. She grew up in Chicago and originally wanted to become a veterinarian. However, when her parents lost their jobs she had to give up that dream and enlisted in the military. Her natural talents quickly led to her enrollment in OCS and she became an officer. After serving with Whitmore in Iraq, she stuck with him when he went into space.

Though young, Brown is an excellent officer and has the practical experience that being an NCO provides. She is loyal to the United States and quite dedicated to Whitmore.

Brown is second in command of the Marine team. Should anything happen to Whitmore, she will assume command of the mission. Like Whitmore, her goals are to rescue the crew, recover the Kesser and protect the United States.

Sergeant Russ Waters, 35 Marine

STR: 17 CON: 14 SIZ: 16 INT: 12
POW: 12 DEX: 13 APP:13 EDU:17
SAN: 60 HP: 15 DB: +1D6

Important Skills: Dodge 38, First Aid 50%, Hide 30% , Listen 45, Martial Arts 41%,

Mechanical Repair 40%, Sneak 50% , Low/Zero Gravity Operations 50%
Weapons: Fist 50% 1D3+1D6, Grapple 45%, Kick 45% 1D6+1D6, Handgun 40% , Rifle 75%, SMG 45% Shotgun 60%

Description: Waters is a large man who has a shaved head and blue eyes. He joined the military right out of high school and intends to be career military until he is forced to retire.

Waters served with Whitmore in Iraq and was impressed by his dedication to his men and the success of his assigned missions. Although Waters is deathly afraid of heights, he volunteered to be part of Whitmore's team. Waters makes a point of never looking towards earth when in space.

Waters prefers to rely on his strength and size to get things done. However, he is not brutal or ill-tempered. He is committed to the completion of the mission.

Sergeant Sarah Winters, 32 Marine

STR: 16 CON: 16 SIZ: 14 INT: 13
POW: 13 DEX: 13 APP:13 EDU:17
SAN: 65 HP: 15 DB: +1D4

Important Skills: Dodge 40%, First Aid 50%, Hide 50%, Listen 45%, Martial Arts 41% Mechanical Repair 30%, Sneak 40%, Low/Zero Gravity Operations 50%
Weapons: Fist 60% 1D3+1D4, Grapple 45%, Kick 55% 1D6+1D4, Handgun 50% , Rifle 65%, SMG 35%, Shotgun 60%

Description: Winters is a tall, fit woman who has blonde hair and blue eyes. She served with Whitmore in Iraq and went along with him into space. While she is utterly dependable, she does not like being responsible for too many people and hence prefers her life as an NCO.

Unlike Waters, she loves heights and often rock climbs when she is on earth. Waters refuses to even watch her climb. Naturally, Winters teases him about his fear.

Winters has no qualm about solving problems with personal violence. When she



caught her ex-husband cheating on her, she broke his nose and left arm. She's very serious about loyalty and will happily give the same treatment to anyone who is unfaithful. Fortunately, in her professional capacity she has very good control over her temper.

Players' Material

The following is a copy of the material that should be made available to the players. It includes the initial email from Dr. Slate, information on the USS Kesser, information on the USS Armstrong and data on the equipment for the mission.

Message from Dr. Slate

You have been selected for a mission of utmost importance to your country. As you know, the USS Kesser has returned.

As you are no doubt aware, the ship was built as a testing platform for the Markelson gate system. Six years ago, when Dr. Markelson activated the gateway, the data feeds from the ship showed that it worked flawlessly. As expected a gateway opened in space and the Kesser went in. But, something went wrong. Rather than quickly reappearing 100,000 kilometers away as planned, she did not return. That is, she did not return until recently.

When the Kesser returned, her communication antenna locked onto the main receiving dish that was used on her first mission. During this lock, a brief transmission was received, giving us hope that there are survivors onboard. After that initial transmission, there has been no contact with the Kesser. We do not know the status of the crew, but we are obligated to rescue them. Because of your reputation and expertise, you are now part of the rescue team.

You are requested to complete any needed personal business within the next two days. Official transportation will be provided to the mission briefing center. There you will undergo a standard pre-flight physical and be briefed on the mission. The estimated maximum mission time is two months.

Sincerely,

Dr. Henry Slate, Chair
Kesser Action Committee

USS Kesser

While the Kesser was constructed as a new vessel, it is based on the same hull as a ship designed for testing drive and power systems. Because of this, the ship is relatively large and has the command section on the end of a boom that extends away from the main body of the ship. The boom was intended to keep the command section at a safer distance from the systems being tested and to also provide a way for the command section to be separated in case of a disaster.

Crew Roster, USS Kesser

Captain Hillary S. Clanson
First Officer Andrew Takei
Navigation Officer Rodney Pike
Medical Officer Yu Chen
Computer Systems Officer Sanja Balikrishnan
Chief Engineer Dmitri Tarksi
Engineer David Pitzen
Engineer Sandra Lewis
Engineer Karl Zubrin
Engineer George Medell
Dr. Kenneth Markelson
Dr. Stuart Foster
Dr. Henry Morricone
Dr. Alisha Russell

USS Kesser Deck Plans

The gray areas on the deck plans do not represent solid hull, but rather the ship's systems that occupy most of that space.

Since the ship is a space vessel, all the hatchways on board are airtight. They are operated manually, exactly like watertight doors on submarines. The airlocks have safety systems that allow only one door to be open at a time. These safety systems can, of course, be overridden by using Electronics. Alternatively, they can be physically destroyed.

Deck One

- 1. Pod Bay:** This area holds the Kesser's two work pods. The pod bay door opens at the front and does so directly to space.
- 2. Equipment Room:** This area holds vacuum suits, spare parts, and tools for working on the pods. Access to this room is via a hatch set in the ceiling.
- 3. Airlock:** This airlock is large enough to hold two people at a time.

Deck Two

- 1. Bridge:** This is the bridge of the ship. It contains the controls for the vessel and its systems. There is a hatch on the deck that allows access to the first deck. The hatch in the ceiling provides access to the third deck.
- 2. Boom Corridor:** The boom corridor provides access to the main body of the ship. The boom itself contains various electronics and other components (the gray area on the plans) that are part of the ship systems. There are various access plates in the corridor that enable people to work on these systems, should the need arise.
- 3. Main Airlock:** The ship's main airlock. There are docking connectors on either side of the ship. There are external and internal airlock controls.
- 4. Boom Corridor:** As above.
- 5. Gateway Focusing Control:** This room contains the instrumentation and equipment for one set of the gateway focusing systems.
- 6. Gateway Focusing Control:** As above.
- 7. Computer System Officer Balikrishnan's Stateroom:** A single occupancy stateroom with a desk, storage, a "bed", and zero-gravity bathroom facilities.
- 8. Captain Clanson's Stateroom:** A single occupancy stateroom.
- 9. First Officer Takei's Stateroom:** A single occupancy stateroom.
- 10. Navigation Officer Pike's Stateroom:** A single occupancy stateroom.
- 11. Pylon Access:** This room provides access to the port gateway pylon. There is a

single person airlock that allows access to the pylon.

- 12. Common Area:** The common area of the ship that functions as a mess hall and living room for the crew.
- 13. Pylon Access:** As above.
- 14. Galley:** This is a zero-gravity kitchen.
- 15. Chief Engineer Tarksi's Stateroom:** A single occupancy stateroom.
- 16. Medical Officer Chen's Stateroom:** A single occupancy stateroom.
- 17. Dr. Markelson's Stateroom:** A single occupancy stateroom.
- 18. Zubrin & Medell's Stateroom:** A single occupancy stateroom.
- 19. Foster & Morricone's Stateroom:** A double occupancy stateroom equipped with two desks, two "beds", and zero-gravity bathroom facilities.
- 20. Lewis & Russell's Stateroom:** A double occupancy stateroom.
- 21. Pitzen & Zubrin's Stateroom:** A double occupancy stateroom.
- 22. Engineering:** The main engineering center. The area contains the direct controls for the ship's drives and power plant as well as access to the machinery. There is a small airlock in this area that allows the engineers to leave the ship to inspect or repair the external parts of the ship's drives.
- 23. Drive access:** This area provides direct access to the drive systems in order to facilitate repairs. When the ship's drive is in operation, this area can be rather dangerous.
- 24. Drive access:** As above.
- 25. Pylon Corridor:** This corridor provides access to the mechanisms and electronics contained in the pylon as well as access to the main gateway nacelle.
- 26. Gateway System Access:** This area provides access to the port gateway systems.
- 27. Pylon Corridor:** As above.
- 26. Gateway System Access:** As above, but for the starboard systems.

Deck Three

1. Emergency Storage: This area contains survival supplies such as rations, water, oxygen canisters and medical equipment. This area is intended for use in the event of a disaster that damages or destroys the main part of the ship.

2. Emergency Quarters: This area provides emergency quarters for the crew. It contains the basic amenities needed for survival.

USS Armstrong

The USS Armstrong is a modular cruiser designed on the same flexibility principle as the original American space shuttle. Like that shuttle, the Armstrong can be equipped with various modules that enable it to undertake different missions. Unlike the shuttle, the Armstrong is strictly a space vessel and is never intended to enter the earth's atmosphere.

The Armstrong and other vessels of the same type are primarily used to maintain satellites, supply the space stations, transport cargo and personal to the moon, conduct experiments and impress the world with America's technical prowess.

The Armstrong's crew consists of NASA and United States Air force personal. While the ship is technically not a military vessel, it does operate with military style discipline.

Crew Roster, USS Armstrong

Captain Natalie Weaver
First Officer Lt. Richard Obama
Navigation Officer Sally Lee
Chief Engineer Kelly Graham
Mission Specialist Heather Roam

Technical Team

Dr. Andrea Skorski
Dr. Helen Abraham
Dr. Ivan Onassis
Engineer Ruth Redwood
Engineer Samuel Cohn

Medical Team

Dr. David Rosenberg
Dr. Ellen Li

Marine Team

Major Thomas Whitmore
Lieutenant Carla Brown
Sergeant Russ Waters
Sergeant Sarah Winters

USS Armstrong Deck Plans

The gray areas on the deck plans do not represent solid hull, but rather the ship's systems that occupy most of that space.

Since the ship is a space vessel, all the hatchways on board are airtight. They are operated manually, exactly like watertight doors on submarines. The airlocks have safety systems that allow only one door to be open at a time. These safety systems can, of course, be overridden by using Electronics. Alternatively, they can be physically destroyed.

Deck One

This deck is actually a cargo module that has been attached to the ship. It can, after the proper procedures have been followed, be jettisoned from the vessel. Naturally, there are multiple safety systems to prevent the module from being jettisoned by accident.

1. Cargo Dock: This area functions as a large cargo airlock and is used to dock with other vessels.

2. Cargo Bay: This is a cargo storage area. Supplies for the mission are stored here including parts and tools for repairing the Kesser. Access to the ship is via a hatch which connects to the center of the Armstrong's main corridor.

Deck Two

This deck consists of the ship itself as well as four attached modules. The modules can



be jettisoned from the vessel, but there are numerous safety (such as physical keys) and failsafe systems to prevent that from happening by accident.

1. Bridge: This is the command bridge of the ship and contains the main controls for the vessel.

2. Operations: This area contains the controls and instruments for functions not directly relating to the ship itself. Normally, these controls are used for specific mission modules attached to the ship. For the current mission the controls have been configured to pilot ROVs and coordinate mission operations.

3. Corridor: A corridor.

4. Captain Weaver's Stateroom: This single occupancy stateroom contains a desk, zero gravity "bed", and zero gravity bathroom facilities.

5. First Officer Obama's Stateroom: A single occupancy stateroom.

6. Navigation Officer Lee's Stateroom: A single occupancy stateroom.

7. Chief Engineer Graham's Stateroom: A single occupancy stateroom.

8. Main Corridor: This corridor runs from the command section to engineering. In the center of the corridor is an airlock system that is intended to provide an extra measure of safety. Access to the dorsal (top) and ventral (bottom) modules is via hatches in the middle airlock.

9. Engineering: This is the engineering section of the ship. This area contains the direct controls for the ship's power plant and drive systems. The area also provides access for repairs and maintenance. There is a small airlock in the aft section of the ship that is used to allow EVA maintenance and inspection of the drives.

10. Dr. Skorski's Stateroom: A single occupancy stateroom.

11. Dr. Abraham's Stateroom: A single occupancy stateroom.

12. Mission Specialist's Roam's Stateroom: A single occupancy stateroom.

13. Engineer Redwood's Stateroom: A single occupancy stateroom.

14. Common Area: This is a common area for socialization and eating. It also functions as the medical treatment area, should the need arise.

15. Dr. Onassis' Stateroom: A single occupancy stateroom.

16. Dr. Rosenberg's Stateroom: A single occupancy stateroom.

17. Dr. Li's Stateroom: A single occupancy stateroom.

18. Engineer Cohn's Stateroom: A single occupancy stateroom.

19. Galley: This is the food preparation area for the ship. Naturally, it is designed for zero gravity cooking.

20. Lieutenant Brown's Stateroom: A single occupancy stateroom.

21. Sergeant Waters' Stateroom: A single occupancy stateroom.

22. Fitness Area: This area is equipped with zero gravity fitness equipment designed to help offset the effects of weightlessness.

23. Sergeant Winters Stateroom: A single occupancy stateroom.

24. Major Whitmore's Stateroom: A single occupancy stateroom.

25. Equipping Room: This room holds vacuum suits, CO2 guns, and the other equipment for EVA.

26. Airlock: This airlock provides access to the ROV bay.

27. ROV Bay: This area holds the mission's three space ROVs and provides a launching area for them. Access to space is via an automatic door. The door's safety system prevents it from opening when the airlock to the bay is open. The bay is normally under pressure but is depressurized for ROV launch or when it is in use as an air lock. The bay can also function as a docking station as equipment to connect to other vessels is located on the exterior of the bay.

Deck Three

Like the first deck, this is a cargo module that has been attached to the main ship.

- 1. Arms Locker:** This area holds the weapons and equipment for the Marines. The locker is armored and reinforced to prevent accidents from damaging the ship.
- 2. Cargo:** This area holds supplies and provisions for the mission.
- 3. Special Component Storage:** This area holds special components for the mission.

Equipment

Equipment List

- 16 First Aid Kits
- 16 Standard Vacuum Suits
- 5 Work Vacuum Suits
- 4 Combat Vacuum suits
- 10 Thruster packs
- 6 CA Advanced Gyro Rifles
- 600 Rounds CAAGR Ammunition of each type.
- 8 CA Advanced Gyro Pistols
- 300 Rounds CAAGP Ammunition of each type.
- 50 Rounds CAAGP Tranquilizer Ammunition
- 4 suits of combat armor.
- 4 Advanced Combat Systems
- 4 Combat Knives
- 20 Flash lights
- 3 “Space Crab” ROVs
- 6 “Flying Spider” ROVs

Equipment Data

The following provides information about the equipment available.

General Equipment

Communication Headset

This is a simple headset radio with a range of 20 km. It can be plugged into a belt unit to give it a range of 100 km. The headset has

a typical battery life of 40 hours. More advanced units will have longer range and greater battery life.

Each member of the team is equipped with a communication headset with a belt unit.

First Aid Kit

A kit is about the size of a book and contains a variety of basic medical supplies that are suitable for first aid use (tape, splints, antibiotics, pain killers, and so forth).

Each member of the team has been issued a first aid kit.

Medical Kit

A medical kit is about the size of a briefcase and contains a variety of medical supplies for treating a range of injuries and illnesses. The kit is also equipped with a small medical computer that aids in diagnosis and treatment. The use of this medical kit provides a +5% bonus to the user’s Medicine or First Aid skill.

Both members of the medical team of medical kits and several are also stored on board the Armstrong.

Smart Com

A smart com, sometimes still referred to as a “smart phone”, is a small device that combines the functions of a computer with that of a full communication system (voice, text, data and video). A smart com has a powerful microprocessor, a substantial amount of RAM, a large capacity storage drive, several user configurable ports and a communications system.

The communication system includes a voice-activated headset. The ones used on the mission have their own radio systems that allow them to communicate directly with each other and also link into the Armstrong’s communication system.

The computer functions of smart coms far exceed those of desktop systems of the 21st



century but they still face the obvious limitation of size (small screens and small keyboards).

These devices take on the combined roles once occupied by smart phones, portable game systems, laptops, PDAs, MP3 players, radios and portable video players.

Each member of the team has a smart com.

Vacuum Suits & Gear

Standard Vacuum Suit

A SVS protects its wearer from radiation, heat, cold and vacuum. Each suit is equipped with an environmental backpack that contains the suit's oxygen supply, power pack and the environmental control system. A SVS can sustain its wearer for twelve hours, less if the wearer is engaged in stressful activities or if the environmental conditions severely tax the suit. The suit helmet is equipped with an audio and video transmitter-receiver (800 km range), polarized visor, and lights. A SVS is typically equipped with a CO2 gun, 200 meters of high strength cable (with a grappling hook on one end and a strong magnet on the other), and a patch kit. A SVS provides its wearer with four points of armor and is self-sealing.

Each member of the rescue team has been issued a SVS. They are stored in locked on board the Armstrong.

Vacuum Work Suit

A VWS is very much like a SVS, except the suit is of heavier construction and can support its wearer for fourteen hours. The suit is specially designed for work and hence actually provides the wearer with better mobility than an SVS. A VWS provides the wearer with six points of armor and is self sealing. A VWS has the equipment of a standard SVS, a mission specific toolkit, as well as an enhanced power system for tools

and accessories. Most models are equipped with on board computers.

There are six VWSs on board the Armstrong. They are assigned to the technical team and the Chief Engineer.

Vacuum Combat Suit

A VCS is very much like the SVS and VWS suits, except it actually is a suit of armor designed for combat in vacuum. A VCS can support its wearer for twelve hours and is equipped with a food supply of concentrates (not tasty, but very nutritional). A VCS has an armor value of twelve. A VCS is equipped with the same accessories as a SVS as well as medical kit. Because they are specifically designed for combat operations, such suits tend to be less cumbersome than standard suits. Further, most VCS are custom fitted to an individual soldier. A VCS is self-sealing.

Each member of the Marine team has been issued a VCS.

CO2 Gun

A standard piece of equipment that comes with all space suits, a CO2 gun looks like an oversized automatic pistol. The handle contains a CO2 cartridge good for 20 one second bursts. Each burst is powerful enough to propel an object with the mass of an average human (including a human, of course) and alter its flight vector. CO2 guns are typically used only in emergencies. Heavy-duty thruster packs are used for normal EVA operations requiring extensive flight.

Thruster Pack

A thruster pack is essentially a personal rocket engine. It attaches to the operator's suit and enables him to maneuver at speeds up to 150 KM/hour. A thruster pack fuel tank is good for about an hour of normal activity, considerably less for high fuel consumption activities, such as using it

within the moon's gravity field (use on the moon cuts its endurance nearly in half). Thruster packs are not powerful enough lift a human within a substantial gravity field, such as that of Mars. A thruster pack can be used (on a low setting) as a weapon with a base chance of 35% and a damage rating of 2D6 (burn damage). Used as a weapon, it has an effective range of half a meter. Normal use of a thruster pack is governed by Low/Zero Gravity Operations skill and any character with this skill can operate a thruster pack in normal conditions.

Patch Kit

A patch kit is used to repair damage to non self-sealing suits and to repair badly damaged self-sealing suits. They can also be used to patch holes in structures and vehicles. The kit consists of four small patches (10 cm diameter), four medium patches (20 cm diameter) and 2 large patches (30 cm diameter), and a spray canister of adhesive. Using a patch consists of peeling off the protective covering on the "sticky" side and pressing it against the hole. The chemical adhesive will bond to almost any surface (living tissue included) instantly, forming an air tight seal. Successful use of a patch, in the typical emergency situation, will generally require a Low/Zero Gravity Operations skill roll, or perhaps a Luck roll, depending on the circumstances.

Weapons & Armor

Constitution Arms Advanced Laser Sight

The CAALS is an advanced version of the basic laser sight developed in the late 20th century. A built in microcomputer controlled feedback mechanism provides the user with the visual data needed to shoot with precision. Used in look-through mode (like a standard optical scope), a CAALS yields a +10% on the users chance to hit with the equipped weapon. Used in pointer (used as

an old style laser scope) mode it provides the user with a +5% chance to hit with the equipped weapon.

Constitution Arms Advanced Gyro Rifle

Base Skill 25% Damage Done: Varies Base Range: 75 yards Attacks Per Round: 3 Ammunition: 16 HPs resistance: 12 Malfunction : 99

Developed for the US Air Force from an earlier model Gyro Rifle, the CAAGR is designed for combat in zero and low gravity situations. This bullpup weapon fires a variety of special two-stage ammunition. The first stage is a gas propellant cartridge which fires the round out of the barrel, while the second stage is a small, yet extremely powerful, chemical rocket that brings the projectile to full speed.

There are four types of ammunition for the CAAGR: Armor Piercing Rod (APR), Shotshell, Safety, Explosive, and Tranquilizer. An APR round is cadmium "needle" which inflicts 1D10 in damage, but treats all armor as a quarter of its normal value. It is designed to punch holes through space suits and vehicle hulls.

The Shotshell round functions as a 12 Gauge shotgun shell (use the statistics for a twelve gauge shotgun), while the Safety Round is made of material designed to shatter against hard surfaces (like base walls and vessel hulls). This type of round inflicts 1D8 and treats all armor as double normal value.

The Explosive Round consists of an explosive device that inflicts 1D10 on the target and 1D3 points of fragmentation damage to everything within half a meter.

The primary advantage of the CAAGR is that its light recoil and integral stabilization mechanism gives provides a -4% adjustment when fired (-2% when braced) in low/zero gravity combat situations. The ammunition types can be mixed in the magazine, but

they can only be fired in order. Advanced Laser Sights are standard on all CAAGRs.

The Armstrong's weapon locker holds six CAAGRs, twelve extra clips and 600 rounds of each type of ammunition.

Constitution Arms Advanced Gyro Pistol

Base Skill 20% Damage Done: Varies Base Range: 30 Attacks Per Round: 2 Ammunition: 6 HPs resistance: 8 Malfunction : 99

Like the CAAGR, the CAAGP is designed for combat in zero and low gravity situations. It is, in essence, a large revolver that fires scaled down versions of the CAAGR rounds. Because of the revolver design, the user can load different rounds and select which one to fire by moving the cylinder.

The APR rounds inflict 1D8 and half the armor value of the target, the Shotgun rounds are treated as a 20 gauge rounds (base range is 8 yards), and the safety rounds inflict 1D6, and the target's armor value is doubled. Explosive rounds inflict 1D8 on the target and inflict no fragmentation damage. The CAAGP can also fire a tranquilizer round. The round inflicts 1D3 points of damage when it hits and injects a tranquilizing drug. Treat the drug as a Potency 14 poison. If the tranquilizer overcomes the target's CON, treat it as a knock out attack that inflicts 14 points of damage (as per the knock out rules in the main rulebook). If the tranquilizer doesn't overcome the target's CON, it has no effect beyond making the target feel a bit woozy.

The CAAGP's recoil is extremely low and the weapon has a special integral stabilizer, giving a -2% adjustment when fired, and -1% when braced in low/zero gravity combat situations. Advanced Laser Sights are standard on CAAGPs.

The Armstrong's weapon locker holds eight CAAGPs and 300 rounds of each type

of ammunition, except for the tranquilizer rounds. There are 50 tranquilizer rounds on board.

Combat Armor

Combat armor is made of advanced composites materials that are both lightweight and very strong. The armor provides heavy protection for vital areas of the body via a helmet, breast plate, arm guards and leg guards. The armor is fitted to each wearer to provide maximum mobility. The armor stops 12 points of damage.

Each member of the Marine team has been issued a suit of combat armor.

Advanced Combat System

The advanced combat system is designed to augment the capabilities of soldiers. The first part of the system is a set of goggles that provide image amplification, flash protection, thermal imaging and light intensification. The goggles also have a heads up display for displaying data. There is also a headset and microphone system that connects to a multiband, encrypted radio system as well as a sound amplification system ("bionic hearing"). The third part of the system is the computer system which provides a wide range of functionality. Standard features include ammunition tracking, a combat database, range finding, communication management, as well as other features that can be programmed into the system.

Each member of the Marine team has been assigned an Advanced Combat System.

Vehicles

"Space Crab" Remotely Operated Vehicle

The Mark IV Space ROV is better known as the "space crab" because it is shaped very much like the body of a crab and has various tools and manipulators. The main body is about one meter across and slightly under

one meter in length. They are battery powered and maneuver via compressed CO2 (to avoid damaging ship hulls). When they need to travel longer distances they rely on chemical rockets that can propel them like a missile.

A ROV has two main manipulator arms (STR 14, 1D4 damage) as well as a variety of smaller tool arms for fine or specialized work. They are also equipped with legs that have sticky feet (based on the Gecko foot) that enable it to walk on any surface. It is also equipped with two front cameras as well as additional cameras for tricky maneuvers. The ROV also has two underbody bays that hold tools and parts. The ROV is also equipped with powerful spot lights.

While ROVs are, as the name states, remotely operated, they have an onboard computer that can be programmed for various tasks. ROVs typically have an emergency program that determines what they do if contact is lost with the controller. Typically they are programmed to return.

Space Crab, ROV

STR: 14 DEX: 10* SIZ: 8 STU: 16
Move 10 HP: 12 DB: +0

Armor: 8 points reinforced hull.

Weapons: Utility hands 1D4* or weapon.

*When being controlled, use the operator's DEX and weapon skills. The utility hands are treated as a punch attack.

“Flying Spider” Remotely Operated Vehicle

The Model 124-A, also known as the Flying Spider, was designed for reconnaissance within space vessels and structures. The 124-A's main body is about the size of a softball and is equipped with CO2 maneuvering jets. The Flying Spider also has six legs that end in sticky feet (based on the Gecko) that enable it to move

about on almost any surface. The Flying Spider also has two small manipulator arms that can be used to push buttons or move small objects (they generate a small bioelectric field that allows them to use devices that sense such fields, such as track pads). While they are usually remotely operated, they also have small onboard computers that can be programmed for various tasks, such as running search patterns.

Flying spiders are equipped with two small cameras (with light intensification and thermal imaging) as well as microphones. Many people find them a bit creepy.

Flying Spider, ROV

STR: 2 DEX: 14* SIZ: 2 STU: 4
Move: 6 HP: 3 DB-1D6

Armor: 1 point hull.

Weapons: None

*When being controlled, use the operator's DEX.

Work Pod

A work pod is designed to hold one operator or be remotely operated and looks somewhat like a small submersible. To avoid damaging ship's hulls, a work pod uses compressed CO2 in its maneuver jets. It is also equipped with a chemical rocket system, should the need arise for more powerful thrust.

A pod is equipped with two manipulator arms (STR 22) that can be used to perform various tasks. The arms end in hands that can duplicate the movements of a human hand. If used to punch a target, they do 1D6+1D6 points of damage. The pod has an external tool box and external part storage. It is also equipped with work lights, a computer, and a long range radio.

A work pod has its own 10 hour supply of air. The battery and fuel systems are good for about 8 hours of normal operation.

A work pod has 8 points of armor and can sustain 18 points of damage before being disabled.

The Second Era

The following provides some general background for the second era. The second era began about fifty years after the Kesser returned. The era was defined by the massive expansion of humanity into space. The two adventures for this era (Dust and The Ship That Waits) are set roughly 250 years in the future (about 200 years after the Kesser returned). Both begin on the colony world of Vanguard.

The Time

After the secret of the Markelson gate system was recovered from the Kesser, humanity surged into space. Suitable worlds were found for colonies and those that did not prove suitable were tapped for resources.

To provide some order and coherence to the expansion of the race, the leaders of humanity created the Colonial Authorities. The Colonial Governmental Authority provided a multi-world coalition of governments and passed laws over matters that affected the entire race. Sensibly, the CGA was granted little authority over local affairs. For the most part, each world has its own governmental bodies (or bodies) and has political autonomy.

The Colonial Military Authority provided a (somewhat) unified military structure for human forces. While each world retained its own autonomous forces, they also provided military units to serve the general needs of mankind. The CMA resembles, in many ways, NATO or the UN Peacekeeping forces of today. The CMA's main purpose is to deal with possible threats to the human race and to help maintain political order among the colonies.

Humans do continue to make war against each other, but the conflicts tend to be

limited affairs over ideology. With a vast universe open for exploitation, the economic motivations for war are significantly reduced. However, there have been and continues to be some unfortunate exceptions. Civil wars tend to be the most common form of conflict, mainly because of the expense of waging war across space and the fact that the CMA does not take such matters lightly.

The CMA generally stays out of purely internal conflicts, unless the conflict is excessively disruptive or is especially vicious.

The Colonial Exploration Authority is in nominal charge of human exploration. While the CEA does have a fleet of scout vessels, it serves primarily as an organizational body that assists colonies in launching and monitoring exploration missions. Most colonies operate within the guidelines of the CEA, mainly because some of those who violated these rather sensible guidelines ended up dead (or worse).

There are some other authorities, but the CGA, CMA and CEA are the best known and most powerful.

While the technology used by humanity has advanced since the 21st century, people remain, for good or bad, basically the same. Most humans retain cultural ties to the nation states of the 21st century and preserve various traditions, such as holidays, dress and foods. The colonies have also created some of their own traditions, holidays and foods as well.

Much to the dismay of the scientific atheists, religion still remains a strong force in the lives of many. Politics is still as popular as ever.

In short, humanity is thriving among the stars and life, as always, goes on.

Vanguard

The investigators begin the two adventures for this era on the colony world of

Vanguard. Although Vanguard was colonized only 150 years ago, it has grown to become an influential economic and political force among the colony worlds.

Vanguard was colonized mainly by Americans and still retains American culture, language and politics. American English is the main language, but most people also speak at least one other language.

Having learned valuable lessons from the Americans of the 21st century, Vanguard has a well trained and active diplomatic corps and maintains excellent relations with other colony worlds.

Like most colonies, the world has a republican form of government in which authority rests with elected representatives. For the most part, Vanguard has been well managed.

The world has an excellent mix of natural resources as well as a creative population. It enjoys a strong economy and is actively involved in trade with numerous other colonies. Some social scientists predict that Vanguard will eclipse earth as the center of political power among the human worlds.

It hosts the sector offices for the CGA, CMA and CEA. While Vanguard devotes most of its resources to economic operations, the world maintains a significant military force. This force was most recently employed in peacekeeping operations on Clarkston.

Clarkston was colonized one hundred years ago and got off to a promising start when valuable minerals were found in abundance. There was some initial worry because the world was colonized by two different groups, but the two seemed to get along well.

But, as so often happens, the wealth from the minerals quickly became a bone of contention between the two groups. Each group believed that it had a better claim to the lion's share of the wealth and this led to

social unrest. The two groups might have been able to work things out, but a charismatic leader arose to fan the flames. Like many such leaders, Hillary Cosento was at first dismissed as a crack pot. However, she was able to gather a group of core loyalists and eventually tapped into old fears and hatreds. Despite the best efforts of CGA mediators, the world plunged into a civil war.

The great mineral wealth of the world enabled it to field significant fleets and armies, thus leading to devastation on a massive scale. Eventually, the war ground to a halt, but not before many people perished. At the request of the two factions, CMA peacekeeping forces were brought in. While the peace was often shattered by acts of violence, eventually the people of Clarkston found their way back to the right path. Vanguard and Clarkston are now very closely allied.

Adventure Two: Dust

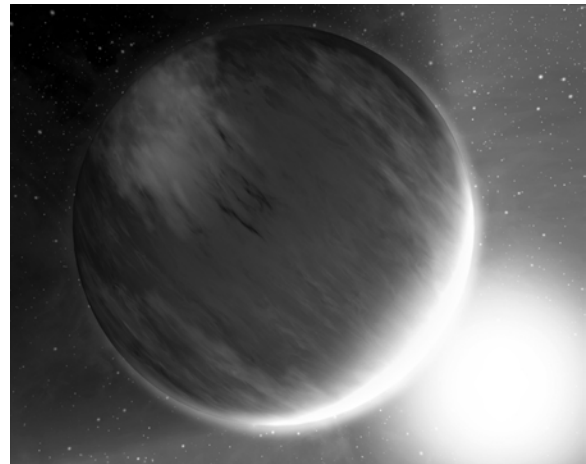

Introduction

In this adventure the investigators will be sent to determine why contact with an expedition on an alien world has been lost. The investigators will confront a horror from

the ancient past. Pre-generated investigators are provided, but players can roll up their own characters if they so desire.

Keeper's Background

The following provides the historical background for the adventure.

A World Dies

Untold eons ago a mighty race reached the pinnacle of its civilization. Their scientists had solved a multitude of great problems and stood at the brink of solving one of the greatest problems of all, that of death. Or so it seemed.

The scientists of the race discovered a way of altering the life energy of creatures that seemingly granted potentially unlimited life. Acting with due caution, the scientists conducted years of tests on animal subjects before one of the scientists, Ka-Sho-Abrin, volunteered to be the first intelligent test subject. After Ka-Sho-Abrin showed no ill effects, nineteen other test subjects underwent the process. These twenty were carefully observed and tested for a decade. When everything seemed to work perfectly, additional subjects were processed and thus joined the ranks of the potentially immortal.

This gradual process continued for five more years until information about the process finally leaked out. Not surprisingly, the politicians and the people demanded that the process become available to the general population. The scientists tried to argue that more time was needed to determine whether the process was truly safe. The politicians responded that the scientists were content to wait because they already benefited from the process and hence had all the time in the world. In the end, the people got what they desired-the process was made available to everyone.

While a few citizens were reluctant to accept the process, the vast majority of the citizens supported devoting substantial

resources to setting up processing centers. While there were a few minor protests, the first public processing centers quickly opened and ran around the clock. The whole world celebrated and the poets poured forth many verses praising a new age and inevitable victory over death. Tragically, this optimism began to fade all too quickly. Within a few weeks, the first disturbing signs appeared. Those who had not yet been converted began to show signs of weakening and this increased with each passing day. It was found that the conversion process ended the weakening and hence the processing, already at a fever pitch, was sped up even more. However, the rate of weakening among the unconverted increased at an exponential rate and some of them began dying. This added substantially to the panic. When it was proposed that the conversion centers be shut down, riots broke out and such proposals were never made again. This was followed by yet another increase in the cases of weakening and death.

Ka-Sho-Abrin, having worked desperately on the problem, discovered the cause of the weakness and death. The conversion process enabled the converted to draw on the life force of other living things. Thus they would strengthen and sustain their own life at the expense of others. Initially, the few converted beings were easily sustained by the vast population of the unconverted. As the number of converted increased, the drain on the unconverted became greater and thus caused weakness and eventually death.

Ka-Sho-Abrin informed his fellow scientists of this fact and they labored mightily to find a way to solve the terrible problem. Some progress was made in reversing the conversion process and one brilliant scientist developed the bare beginnings of an artificial way of sustaining the converted. Ka-Sho-Abrin found a way to dampen the effects of the life drain and built a prototype bunker in the hopes that the

unconverted would be able to survive in such structures.

Unfortunately, time ran out for the world. The conversion process continued unabated and the unconverted continued to die. Ka-Sho-Abrin gathered together a group of the unconverted, members of a religious sect who had refused the process, and convinced them to seek shelter in his bunker.

Eventually, the day arrived when only the converted (with the exception of those in Ka-Sho-Abrin's secret bunker) remained.

Most of the people thought the horror had come to an end. The survivors shed tears for those who had perished and breathed sighs of relief that they had not been among the dead. Unfortunately, the horror had only just begun. Soon, the converted began to weaken and die.

Ka-Sho-Abrin determined that the converted had begun to feed on each other. He also found that those who had been among the converted the longest were stronger than the more newly converted. He determined that the stronger converts would drain the weaker converts until, in theory, only one would remain.

Ka-Sho-Abrin and his fellows worked desperately to perfect the artificial energy system that would sustain the people. Ka-Sho-Abrin also worked secretly on perfecting the shielding in his secret bunker and convinced the unconverted to go into hibernation chambers that had been designed years earlier as part of the planet's space program—a program that had been abandoned completely to help fund the massive conversion process. His desperate plan was to have the unconverted outlive the converted and, hopefully, rebuild the race.

In an ironic coincidence, some of the scientists suggested building space ships so they could find other worlds to sustain them. Ka-Sho-Abrin tried to persuade them to abandon such efforts. He failed, so with great sadness and reluctance, he destroyed

them. He had decided that if he could not undo the plague, then he would see to it that it ended on his world.

As it became evident that the converted were feeding on each other, violence erupted across the planet. Civilization collapsed completely. The world became a nightmare as the stronger survivors drained the weaker and tried to avoid the same fate. Eventually, only the original converts remained alive, still trying to find some way out of the nightmare. They agreed to remain together in the hopes that at least some of them would last long enough to find a solution. These few eventually dwindled down to one as Ka-Sho-Abrin, the oldest convert, drained the last drops of life from his fellows.

Ka-Sho-Abrin left the research complex for the last time and walked the dead streets of his world. He found that all life on his world, even the plants and microorganisms, had been reduced to naught but dust. His tears fell into the dust and he was prepared for death. He believed that as his life force faded, he would simply die and the nightmare would end. He was, unfortunately, horrifically mistaken.

He wandered about for several days as he waited to die, growing weaker with each passing hour. Eventually he collapsed into the dust, thinking that death had arrived to claim him. His consciousness faded away, but his existence did not end. He arose again from the dust, a twisted mockery of life. Though his intellect was gone, some shreds of his memory remained and these guided him towards the last source of sustenance on the world—the bunker.

Gaining access to the bunker, he collapsed amidst the hibernation tubes. Protected somewhat by the tubes, the sleepers lost their life energy slowly and thus sustained Ka-Sho-Abrin across the centuries.

The world of dust remained silent and lifeless until the arrival of humanity.



Footsteps in the Dust

The Markelson Gate System gave humanity the means to fulfill the dream of going to the stars. So equipped, humans began to live that dream with a vengeance as ships left earth to plant colonies on alien worlds. These colonies, in turn, constructed their own ships and these vessels headed out deeper into the vast darkness. During this expansion, human scouts encountered many wonders, horrors and mysteries.

The leading edge of the expansion was a wave of automated probes. They flitted from system to system looking for valuable resources, habitable worlds and potential foes of the expanding human race.

Sixty years ago one of these automated probes entered what became known as the Richard system. In accord with its primary mission, the probe scanned for signs of intelligent life. Finding none, it conducted a routine survey for resources and sent a data torpedo back into human space. It then departed and moved on to its next mission.

Twenty years later, a manned mission led by Captain Walter Richard arrived in the system. When the scout team reached the only world in the star's habitable zone, they were surprised when their sensors revealed massive structures all over the planet's surface. There was a period of frenzied activity as the scout crew simultaneously prepared to be attacked and conducted rapid scans of the world. What they found both shocked and amazed them-the entire world seemed to be dead. No artificial energy sources could be detected, no response to their presence was forthcoming and there seemed to be no signs of life at all. Captain Richard later noted in his log that his first impression was that he was gazing down at a world-spanning cemetery.

After taking suitable precautions, the scout vessel sent down a landing team to investigate a promising area. They reported that the massive structures were empty of

everything but dust. This dust also seemed to cover the whole world. Robotic probes zipped around the planet collecting data that confirmed Richard's feeling-the world was, as far as could be determined, completely dead. Not even living bacteria were detected anywhere.

Richard reported his findings and, as per protocol, a more substantial scouting mission arrived to investigate the remains of the alien civilization. Several public and private research teams, hoping to glean secrets from the alien ruins, followed this mission. The planet proved, however, to be a bitter disappointment. Nothing was found but empty structures, dust and more dust.

Oddly enough, the research teams all reported unusual levels of illness and depression among their personal, but this was (after some investigation) attributed to the bleak nature of the world rather than to any threatening causal agent.

Finding nothing of value and having become quite tired of the empty, depressing world, all research teams, save one, abandoned the planet. Katrina Lee, a reclusive billionaire who had made her fortune in alien artifacts, was convinced that the world still held something of value. As such, her private team remained on the world. Eventually, even the high salaries she offered could not keep top researchers in such a dreary, dusty and desolate setting. Lee then had to resort to hiring those who could not find legitimate employment elsewhere, those few who shared her devotion and those so new to the field that they had to take whatever was available.

After years of fruitless and tedious searching through empty, dust filled structures the research team chanced upon the bunker of Ka-Sho-Abrin. Finding that the structure actually contained items of interest, the research team members let their excitement get the better of them. Ignoring the standard procedures for safety and

proper investigation, they rushed into the structure, eager to discern its secrets.

The team was amazed when they found the first hibernation chamber and recognizing it for what it was, hoped they would find a survivor. Unfortunately, their hope was realized-but not as they expected.

Seeing the dead aliens had a sobering effect on Dr. Keck and she warned the others to slow down and follow the proper procedures. Unfortunately, the others did not listen to her. Hoping for a career making discovery, the graduate students rushed to the final level of the bunker. There they encountered the remains of Ka-Sho-Abrin. With no bunker walls between him and the students, Ka-Sho-Abrin's remains began sucking away the life energy of the students. Unsure of what was happening, but terrified by the feeling that their life was being stolen away, the students screamed and tried to flee. However, it was too late for them. Their drained bodies fell to the floor, seemingly dead.

Hearing the screams over their radios, the older scientists rushed to the final level of the bunker. Sensing that something was wrong, Keck hung back and told the others to stay away from the bodies. Harn and Clay ignored her, and moved to help the students.

Keck's fears proved to be well founded. Harn and Clay felt their life energy being stolen away. As they tried to flee, the students grabbed onto them and drained them completely. Keck, her well developed survival instincts overcoming her terror, fled the bunker and fled from the bunker. Abandoning the husks of the drained scientists, the students set off in pursuit. They knew that Keck would tell the others and they were terrified that the support team might consider them to be "contaminated beyond recovery" and decide to kill them. Or worse, turn them over to the company for research.

The students exited the bunker to see Keck driving away in a cloud of dust. Always a quick thinker, Tumlen realized that they would not be able to overtake her. As such, she called the outpost to tell the support team that Keck had suddenly snapped. She related a tale about how Keck had killed the other scientists, tried to kill the graduate students and was now on her way to try to kill the support team. Knowing Keck's violent past, the support team found the story quite plausible.

Hearing this on her radio, Keck tried to convince the support team that the students had been transformed by something within the bunker. Not surprisingly, this merely served to convince the support team that Keck had, in fact, gone mad.

Realizing that she could not return to the outpost, Keck drove to an abandoned outpost and began trying to think of a way to survive yet another disaster.

The students arrived at the outpost and were greeted by the support team. The students originally had no intentions of harming the support team, but they were filled with an overpowering craving when they encountered their colleagues. Not suspecting any treachery, the support team was overpowered and drained by the students. The students found that they could return some of their stolen energy back to their victims and restore them to an unnatural semblance of life that matched their own.

After recovering somewhat from the horror of their situation, the students and the support team members discussed what they should do. At first, the support team considered contacting the Reed and telling the crew what had happened. However, the graduate students pointed out that there was a good chance they would either be killed or treated as scientific finds. Tumlen suggested that they contact the Reed and tell them that a medical emergency had arisen. They



would then return to civilization and make their plight publicly known to a reputable hospital so as to avoid a terrible fate. Everyone agreed that this plan was an excellent idea and they implemented it. Before leaving, they destroyed the outpost's communication system and all the spare parts. After all, they reasoned, it would not do for Keck to contact the Reed.

When the shuttle arrived at the Reed, they quickly went off plan. They were met at the docking arm by Holstein and Chun. Overcome by their terrible hunger, the students and support team overpowered the two and then converted them. Realizing they could not control themselves, the students and support team members had a heated argument about what to do. When the Captain called the docking arm, they made up their minds: they would take the ship and return to civilization. However, they would not return to seek help. They would return to feed.

They went to the bridge and jumped the Captain. Seeing this, Sally Rhodes had just enough time to call her husband, John, in the starboard engineering access. Seeing his wife grabbed, drained and returned to life made it quite obvious to John that something horrible had happened.

He overheard Chun saying that they would need to convert him so he could activate the Markelson Gate system and bring them to a world teeming with life. Realizing that the communication link was still on, Chun quickly shut it off.

A decisive man, Rhodes immediately took action. He reactivated the military protocols in the two cargo robots. He then overrode the drone bay safety protocols just as Holstein and Chun were on their way to him. Hearing them at the hatch, he exposed the storage bay to vacuum, thus blowing Holstein and Chun out into space. Realizing what he was doing, the others donned

vacuum suits while his wife pleaded with him to join them.

Knowing that the Captain could override the robots and that the others had donned vacuum suits, he knew that his options had run out. If the invaders reached him, they would be able to convert him and he would gladly activate the gate system. John's resolve was strengthened by the conditioning he went through during his training. This conditioning was intended to help prevent the gateway technology from falling into alien hands. John entered the command that burned out the gateway system and it was quickly reduced to unusable slag. After doing that, John decided that the Reed must be completely disabled. He welded the access hatch and then set to work overriding the safety systems on the drive. He managed to complete the process just as Keller was cutting through the hatch. The exploding drive killed Keller and Rhodes.

Realizing that the Reed was a dead ship, the others took the shuttles back to the planet's surface.

While the students and support team were on the Reed, Keck returned to the outpost. Finding the communication system destroyed, she gave up her plan of contacting the Reed. She gathered up weapons and supplies and then turned the outpost telescope onto the Reed. After seeing the starboard drive explode, she inferred that things had gone badly. When she saw the shuttles departing the Reed, she ignited the shuttle fuel at the landing field and then fled the area.

After the shuttles landed, those onboard found that they were trapped on the planet. They also found that their hunger was growing. They knew that when the Reed failed to launch its message torpedo, the company would send a rescue team. They would be ready to take them and depart the

world with their vessel. It is into this situation that the investigators will arrive.

Getting the Investigators Involved

The investigators will be contacted by Andrea Sloan, an agent of Katrina Lee. Investigators who are part of a team will be contacted as a group while independent investigators will be contacted individually. The adventure is written on the assumption that most (if not all) of the investigators are part of the Portland Trouble Team, an independent outfit that takes on various risky missions for those who have the resources to make it worthwhile.

Sloan will first provide the investigators with standard non-disclosure and secrecy contracts. The contracts specify that they will neither reveal nor act upon the information she provides should they decide to turn down the employment offer. Once the investigators agree to contracts, she will arrange a meeting (either in person or virtual).

After the introductions are made, she will say the following:

“As you no doubt know, Lee Industries is involved in a variety of endeavors in numerous systems. Some of these are purely financial efforts while others are dedicated to furthering human knowledge. Naturally, with such a broad range of activities, trouble is bound to arise.

Some of you might know about Richard’s World. It was discovered sixty years ago by automated probes and explored forty years ago by a team lead by Captain Walter Richard. Richard’s expedition found that the world had been inhabited and this created quite a stir in the scientific community. Unfortunately, the initial excitement gave way to disappointment: despite numerous expeditions, nothing worthwhile was found on the world and almost everyone gave up.

Lee Industries was among those who sponsored the scientific expeditions. Unlike the others, Lee Industries does not give up easily. The company has continued to fund a research team on the world. This takes me to why you are here.

As you might have guessed, something seems to have gone wrong. Standard policy requires that human expeditions on alien worlds check in with a governing authority each week via a message torpedo. When the torpedo was not received, a message torpedo was dispatched by the company to the system. When the torpedo arrived it attempted to contact the team’s support vessel and the ground base. The torpedo received no reply from either, other than the automated landing beacon signal for the ground base.

Obviously, we are concerned that some disaster has befallen the research team. The company has contacted the Colonial Governmental Authority as the law requires and we have been assured that an expedition will be sent to investigate within the month.

However, Lee Industries takes the well being of its people very seriously and it has been decided that we cannot wait for official action. As such, I have been authorized to offer you a mission contract.

Your mission will be to go to Richard’s world and determine what has happened to the expedition. You have been provided with a standard contract that specifies your payment and compensation. Naturally, there is the standard clause that any significant finds become the property of Less Industries. Should you make such a find, you will be properly compensated, as per section 43, subsection 76 of the contract.

The safety of the personnel on the world is of great importance. As such, the primary objective of the mission will be to locate and rescue our people.

While I know the value of taking time to consider an offer, time is of the essence. We

need to leave for Richard's world immediately. Do you accept this mission?"

The investigators can negotiate their contact using Law and Persuade or they can accept it. The contract is fair, even generous in its terms. If the investigators reject the contract, then they are on their own. If they go to Richard's world on their own, they will be subject to prosecution. If they decide not to go at all, then the adventure ends.

Assuming the investigators accept the contract, Sloan will continue:

"Excellent. The company is uploading the relevant data to you. All clearances and permits are being taken care of right now and we will be ready to depart within six hours. I will meet you on the Portland in two hours."

Investigation

The investigators will have the data provided by Lee Industries and they can also conduct some research on their own. Before meeting Sloan, they might wish to do some investigation as well.

Lee Industries & Katrina Lee

According to public information sources, Lee Industries was founded by Katrina Lee. Dr. Lee began her career as a xeno-archeologist and made her fortune by discovering and marketing alien technology. Unlike many academics, she proved to have excellent business sense and was able to transform her business into a multisystem corporation.

Dr. Lee is still well respected in her field, although some jealous colleagues have accused her of selling out to commercial interests.

In recent years, Dr. Lee has become somewhat reclusive and there are rumors that she has decided to retire from her company and allow the next generation to

take over. She is unmarried and has no children.

Lee Industries is primarily involved in the development of new technologies based on alien finds. They generally stay out of the production business and instead license their technologies to other companies.

Not surprisingly, Lee Industries actively funds expeditions and provides scholarships and grants to promising students. While this generally creates good press for the company, some critics have expressed concern about how Lee Industries and other companies have served to commercialize the science of xeno-archeology to the detriment of the science. Lee Industries' standard reply is that such sources of income are essential for xeno-archeology. After all, as their PR people constantly point out, expeditions to other worlds are very expensive.

If the investigators decide to dig deeper using Library Use, they will find that the company and Dr. Lee seem to match the public profiles. They will find, however, that a few expeditions funded by Lee Industries ended in disaster. However, exploring alien worlds is a dangerous business; hence such occurrences are not unexpected. Lee Industries safety record compares favorably to those of other companies.

One reference the investigators might find interesting is from a critical academic article in the *Journal of Xeno-Archeology* by Dr. Marvin Shelly. The gist of the article is that the commercialization of xeno-archeology has led scientists to take more risks and this has caused some unnecessary disasters. He argues that xeno-archeology should be better regulated and that scientists should be more careful in their research.

"...While Lee Industries has contributed greatly to xeno-archeology, it has contributed greatly to the commercialization of the field. This has led the researchers it employs to take more risks than should be

taken and has led to some serious and deadly consequences.

One noteworthy incident occurred in the Temsha asteroid belt. A research team found a derelict alien craft on one of the asteroids. Rather than informing the authorities of the find immediately, the team attempted to board the vessel. The ship proved to still have at least one active weapon system and the research team's ship was badly damaged. Fortunately, no one was killed.

Perhaps the most tragic incident involving the company occurred on one of the moons of Langston IV. A research team on that moon found what later proved to be an alien chemical weapon laboratory. Unfortunately, this fact was not determined until after the entire team has been killed by one of their finds-an extremely potent chemical weapon. This find proved quite valuable for the company, but at the cost of seventeen lives...

If the investigators confront Sloan about the danger, she will acknowledge that xeno-archeology is dangerous. She will, however, point out that the company has strict safety protocols that are approved by the top academic departments. She will also point out that the company cares about its people as evidenced by the current mission.

Andrea Sloan

If the investigators research Andrea Sloan, they will find basic information about her on the planetary web. She does not participate in any social or professional networking sites.

If they dig deeper using Library Use or Computer Use, they will find that she received a B.S. in xeno-archeology and then joined the military during the civil war on Clarkston. The records show that her parents, older brother and younger sister were killed during the fighting. She was decorated several times and was promoted to

the rank of Captain. After the war ended, she returned to school and completed her M.S. She was then hired by Lee Industries and has been involved with several successful expeditions. She is still on reserve status with the Colonial Military Authority.

Lee Industries Personnel

The investigators will be given the personnel roster for Richard's World and the professional dossiers on the team members.

The Reed crew members are listed as independent contractors. Their professional records are clean and they have been involved in expedition support for about a decade.

The research team members have somewhat less clean records. Sloan will be upfront about the fact that Richard's world is something of a dumping ground for flawed academics and company personnel.

Dr. Clay had a promising career at a major university, but had poor impulse control in regards to his female students. The university overlooked his indiscretions for quite some time, but eventually fired him in the face of numerous law suits alleging harassment. He was hired by Lee Industries after going through extensive sensitivity training and agreeing to go on medication for his behavioral problems.

Dr. Janet Harn also had a promising early career, but could never quite get around to meeting the requirements for tenure. She drifted from school to school and finally ended up taking a job with Lee Industries.

Dr. Sarah Keck was doing research on Kefler when some of the natives decided that her team had violated their taboos. The full facts of the situation were never quite sorted out, but it is known that Keck was the only survivor. She was picked up from the wilderness by a contracted rescue team. According to the report filed by the rescue team she had in her possession "one knife, one Berretta LP-23, and three heads taken



from the native race.” While Keck was cleared of criminal charges, she was accused of being violently xenophobic and banned from working on inhabited alien worlds. After undergoing therapy, she was hired by Lee Industries.

The graduate students are all from a small school on Vanguard that could not normally afford to send them all on an expedition to an alien world. Their psychological profiles are all normal.

The support team members have been assigned to the expedition due to minor job infractions. Ted Younger was found to have flown missions while slightly impaired by alcohol. Bina Keller received numerous reprimands for sloppy work and Dr. Knight recently underwent treatment for addiction to prescription pain killers. Lee Industries has a redemption policy and attempts to give fallen employees a second chance. To minimize the risk to the company, such people are sent to the most unpromising locations as a last chance. If they succeed, the company profits from what appeared to be an unprofitable situation. If they screw up again, it is no great loss and they are fired.

Lee Industries Personal, Richard’s World

Edgar J. Reed Crew

Captain: Owen Taggart

Pilot: Sally Rhodes

Engineer: John Rhodes

Shuttle Pilot: Rhonda Chun

Cargo Master: Amjed Holstein

Research Team (Ground)

Dr. Wilbur Clay

Dr. Janet Harn

Dr. Sarah Keck

Graduate Students (Ground)

Thomas Goldberg

Shali Tumlen

William Chopah

Lo Winston

Support Team (Ground)

Shuttle Pilot: Ted Younger

Engineer: Bina Keller

Medical: Dr. Laura Knight

Edgar J. Reed

The Reed is a surplus drone carrier from the Clarkston civil war. Naturally, it was stripped of its combat drones and refitted as support vessel.

The investigators will be provided with deck plans for the Reed as well as information about the ship.

The Outpost

The outpost was built out of three habitation modules and a vehicle bay. A custom greenhouse was added to the outpost three years ago using material salvaged from an abandoned outpost camp. The outpost has been in operation on the planet for seven years. The investigators will be provided with the plans for the outpost.

Richard’s World

Data on Richard’s world is readily available in the public data system. The investigators will also be provided with information about the planet and its history.

The following is the standard information about the world:

“Sixty years ago an automated probe entered what is now known as the Richard system. In accord with its primary mission, the probe scanned for signs of intelligent life. Finding none, it conducted a routine survey for resources and sent a data torpedo back into human space. It then departed and moved on to its next mission.

Twenty years latter, a manned mission lead by Captain Walter Richard arrived in the system. When the scout team reached the only world in the star’s habitable zone, they were surprised when their sensors revealed

massive structures all over the planet's surface. What they found, upon further investigation, both shocked and amazed them-the entire world seemed to be dead. No artificial energy sources could be detected, no response to their presence was forthcoming and there seemed to be no signs of life at all. Captain Richard later noted in his log that he felt he was "gazing down at a world-spanning cemetery."

After taking suitable precautions, the scout vessel sent down a landing team to investigate a promising area. They reported that the massive structures were empty of everything but dust. This dust also seemed to cover the whole world. Robotic probes confirmed Richard's impression-the world was, as far as could be determined, completely dead. Not even living bacteria were detected anywhere.

Richard reported his findings and, as per protocol, a more substantial scouting mission arrived to investigate the remains of the alien civilization. Several public and private research teams, hoping to glean secrets from the alien ruins, followed this mission. The planet proved, however, to be a bitter disappointment. Nothing was found but empty structures, dust and more dust.

Initially, some scientists speculated that the world never had life and that an alien race had come to the world to construct the structures for some unknown reason. However, examination of the world's fossil record showed that life had existed in abundance on the world prior to whatever event led to the complete die off. Signs of historic civilizations were found that showed continuity with the most recent structures. This evidence showed that there had been life and an advanced civilization native to the world and that somehow everything had died within a relative short span of years.

One unusual fact about the world was that the research teams all reported unusual levels of illness and depression among their

personal. This fact led some to speculate that whatever killed the original inhabitants might have left lingering traces. Naturally, the world was carefully investigated for pathogens, radiation and toxins. However, no environmental factors were even found. Psychologists eventually attributed the feelings to the bleak nature of the world rather than to any harmful causal agent.

The scientists continued to investigate the world in the hopes of determining what had killed everything on the planet. Numerous theories were advanced and most of these involved wars, technological disasters, or ecological disasters. However, no satisfactory theory was ever found. Eventually, the theorists moved on to newer problems and Richard's world remains a mystery.

With the exception of Lee Industries, all other expeditions eventually left the planet empty handed. Lee Industries currently maintains a research outpost on the world.

In terms of its physical characteristics, the world was once very much like earth. In some ways, it still is. Like earth, it is a rocky planet with a molten core. Like earth, it has active weather patterns. It is also roughly the same size and density of earth, giving it .9 earth gravity.

The atmosphere was once a breathable oxygen-nitrogen mix. However, the absence of plant life means that humans must wear oxygen masks when on the world. Pressure suits are not needed since the atmospheric pressure is tolerable.

Naturally, the complete lack of life has had a huge impact on the world. Without plants to hold soil in place, the world has constant and massive dust storms. In this regard, the world has provided an excellent, albeit extreme, example of environmental disaster."

What Happened?



Naturally, there will be speculation about what happened to the expedition. Sloan thinks that there are four main possibilities. The first is that the expedition lost contact due to the failure of their communication equipment. In this case, it will be easy money for the investigators. The second is that the expedition suffered an internally dispute that ended badly. Sloan has considered the possibility that Keck turned against the others. In this case, the investigators will have to deal with Keck. A third possibility is that the expedition found something valuable and has decided to sell it to another company. If this proves to be the case, Sloan says that she will have another mission for the investigators. A fourth possibility is that the expedition encountered some disaster. Perhaps something they found on the planet. Perhaps something that found them.

Maps

The following provides the details regarding the maps for the adventure. The players' versions of the map keys are provided in the section containing the players' material.

Portland Deck Plans

The Portland is a Maine class scout ship. Large numbers of this class were constructed for the Colonial Expedition Authority. As the ships were replaced by newer models, many of them were sold as surplus or provided to retired scout personnel.

While the Maine class scouts are relatively small vessels, they have well designed crew staterooms and are extremely reliable. They are also well loved by their crews for their capacity to survive alarming amounts of damage.

A Maine class scout is armed with two Class II pulse lasers, equipped with artificial gravity systems and a Markelson Gateway

System. The hatches on the ship are, of course, air tight and manually operated. There are automated safety systems to prevent the airlocks and hatches from exposing the interior of the ship to vacuum. Maine class scouts are capable of atmospheric flight and can even operate, for a limited time, in fluids.

Deck One Cargo Deck

1. Gunnery: This is the access area for the ship's offensive armament: two Class II pulse lasers. The lasers can be directed from the bridge or controlled from here. A hatch provides access to this area. While some ships have been stripped of their armament, the Portland retains her guns.

2. Cargo Bay: The ship's modest cargo bay. It is mostly used to carry supplies for the crew but can be used to transport other items as well. Some scout owners have been able to make a living transporting small, but valuable cargoes.

3. Vehicle Bay/Cargo Lift: This area contains a cargo lift for loading heavier cargo. Most scouts are equipped with a small vehicle. The Portland carries a Rugged Rover ATV.

Deck Two: Main Deck

1. Ship Systems: This area provides access to the ship's computer and control systems. The hatch has a security lock on it to prevent unauthorized access.

2. Corridor: This is the main corridor. A hatch in the floor provides access to the gunnery section.

3. Stateroom: A stateroom that can be setup for dual or single occupancy. Each room is equipped with basic bathroom facilities.

4. Head: The ship's bathroom facilities.

5. Stateroom: A stateroom.

6. Stateroom: A stateroom.

7. Common Area/Medical: This is the common area of the ship. It can be quickly

converted into a workout area or a medical area. It is normally set up like a lounge area.

8. Engineering: This is the ship's engineering section. Access to key systems for repairs and maintenance is via this area.

9. Ship's Locker: The ship's equipment locker. Weapons, vacuum suits and other such equipment are stored here.

10. Airlock: The ship's airlock. The airlock is manually operated but has an automated safety system that prevents both doors from being opened at once when there is a significant pressure difference between the exterior and the interior.

Deck Three: Command Deck

1. Bridge: This is the bridge of the ship. There are stations for the pilot, gunner, navigator and captain. The ship can be operated by one person by reconfiguring the controls to provide helm, gunnery and navigation control at one station.

2. Operations: This is the operations room and provides stations for two sensor operators. It can also be used a conference room.

3. Corridor: A corridor.

4-7. Staterooms: Staterooms.

8. Gateway Engineering: This area provides access to the ship's Markelson Gateway System. The door is security locked and reinforced. The drive system is, as all such drives are, with a destruction system intended to keep the drive technology from falling into alien hands.

Edgar J. Reed

The Edgar J. Reed is a Tonya Wei class drone carrier. Drone carriers of varying sizes were constructed in large numbers to serve as cheap and simple warships. As their name implies, they relied on armed drones as their offensive weapons. During the Clarkston Civil War both sides employed large numbers of the small Wei class vessels. After the war ended, most of the surviving

vessels were stripped of their drones and sold as surplus. These ships are now commonly seen as small cargo vessels and support ships.

While a Wei class ship is of moderate size, they are generally disliked because of their cramped crew quarters. Since the ships were designed to carry and repair drones, most of the ship was given over to those functions. Most of the surplus vessels had their storage areas turned into cargo bays and their repair area converted into additional crew space (or even more cargo area).

A Wei class drone carrier is typically unarmed. They were not built with any weapon hard points and hence cannot safely mount weapons. Some owners do purchase a surplus combat drone or two for defense.

Most Wei class ships were hastily constructed during the war and corners were often cut in their construction. This has led to surplus ships having a fairly high accident rate. The most common accident is a serious structural failure where the drives connect to the hull.

The hatches on the ship are, of course, air tight and manually operated. There are automated safety systems to prevent the airlocks and hatches from exposing the interior of the ship to vacuum. Like all modern ships, the Wei class vessels are equipped with artificial gravity. The original vessels were equipped with Markelson Gateway systems, but most of those built during the Clarkston civil war lack this system and were deployed only in orbit around the planet. The Edgar J. Reed has a Markelson Gateway System.

The Wei class was originally equipped with two ship's boats or shuttle craft. These were mostly used for drone recovery after battles and transporting the ship's crew to and from a planet. A Wei class Drone carrier is not capable of atmospheric flight, although they do crash quite well.



The investigators will find that the Reed is now somewhat different from what the deck plans and descriptions specify. The Reed's starboard drive nacelle is badly damaged, much of the ship is exposed to vacuum, the artificial gravity is off, there are bodies aboard and two hostile robots roam the vessel. The details of the situation are provided in the action section for the Reed, which is below.

Edgar J. Reed Deck Plans

Deck One: Launch Deck

- 1. Drone Launch Deck:** The main feature of this deck is the drone launch bay. The drones were deployed via the main hatch. Drones were moved to and from the launch bay via the lift. This lift allows access to decks one through five. Each deck has a mechanical airtight hatch that the lift passes through. The lift was designed to carry standard naval drones. This area is used a cargo bay on the Reed. Initially, the Reed's launch bay door will be open and this area will be in vacuum.
- 2. Starboard Docking Arm:** This area provides access, via a hatch, to an attached small craft.
- 3. Airlock:** A standard airlock, complete with automatic safety system.
- 4. Corridor:** The corridor functions as an airlock that allows access to the drone bay.
- 5. Elevator:** This lift is designed for crew use.
- 6. Airlock:** A standard airlock.
- 7. Port Docking Arm:** The port docking arm.

Deck Two: Storage Deck

- 1. Drone Storage:** This area was used to store drones. It is used for cargo and storage on the Reed. At the start of the adventure, the lift doors will be open and this area will be in vacuum conditions.
- 2. Crew Elevator:** The lift for the crew.

3. Starboard Drive: The starboard drive and Gateway system. This drive is badly damaged.

4. Port Drive: The port drive.

Deck Three Storage Deck

- 1. Drone Storage:** This area was used to store drones. It is used for cargo and storage on the Reed. At the start of the adventure, the lift doors will be open and this area will be in vacuum conditions. The remains of Keller float in this room.
- 2. Crew Elevator:** The lift for the crew.
- 3. Starboard Engineering Access:** This area once provided access to the ship drives and gate systems. It is now a twisted ruin. The shredded remains of John Rhodes are splattered about on the surfaces.
- 4. Starboard Drive:** This was the starboard drive and Gateway system. It is now a twisted ruin and is barely attached to the ship.
- 5. Port Engineering Access:** This area provides access to the ship drive systems.
- 6. Port Drive:** The port drive.

Deck Four Storage Deck

- 1. Drone Storage:** This area was used to store drones. It is used for cargo and storage on the Reed. At the start of the adventure, the lift doors will be open and this area will be in vacuum conditions.
- 2. Crew Elevator:** The lift for the crew.

Deck Five: Drone Servicing

- 1. Drone Repair:** This area was used to repair and service the combat drones. This area has been converted into a common and fitness area on the Reed. At the start of the adventure, the lift doors will be open and this area will be in vacuum conditions.
- 2. Crew Elevator:** The lift for the crew.
- 3. Airlock :** A standard airlock.
- 4. Corridor:** A corridor.
- 5. Tool Room/Starboard Galley:** This area was originally a tool room. It now provides

a small food preparation and dining area for the crew.

6-8. Storage/Quarters: These areas were originally used as storage for drone parts. On the Reed they have been converted into single occupancy staterooms.

9. Tool Room/ Starboard Head: This area was originally a tool room, but was converted to the starboard bathroom.

10. Corridor: A corridor.

11. Port Galley: This area is small food preparation and dining area for the crew.

12-14. Quarters: These are crew staterooms.

15. Port Head: The ship's portside bathroom.

Deck Six: Crew Deck

1. Common Area: A common area for the crew. It also doubles as the ship's sickbay.

2. Elevator

3-6. Crew Staterooms: These were originally the quarters for the ship's officers. On the Reed they are the crew's quarters.

7. Bridge: The Bridge has stations for the helmsman, navigator, captain and drone officer.

Outpost Floor Plans

The outpost is composed of three habitat modules, one vehicle bay and a custom made greenhouse. Because of the unsuitable atmosphere on the world, the modules are environmentally sealed and have their own air supply. There is a shuttle landing field within walking distance of the outpost. The field is paved and has an automated beacon as well as fuel facilities.

1. Green House: The greenhouse was added to the outpost using material scavenged from abandoned outposts.

2. Corridor: A corridor.

3. Power plant: The power plant provides energy and life support for the outpost module. The plant also has a battery system

that can power the outpost for several days of normal use. The outpost modules have solar panels on them to provide the needed energy.

4. Locker: An equipment locker. Fully stocked, the locker holds 2 medical kits, six re-breather masks, two Berretta LP-24s, and one Armtech LR 475.

5. Airlock: A standard airlock. It is equipped with an automated safety system.

6-10. Quarters: These are living areas for the personnel.

11. Bathroom: Bathroom facilities.

12. Kitchen/Dinning Room: An automated food preparation and dining area.

13. Power plant: A power plant.

14. Locker: As above.

15. Airlock: A standard airlock.

16. Corridor: A corridor.

17. Exercise Room: An exercise area equipped with various fitness items.

18. Bathroom: A bathroom.

19-21. Quarters: Living space.

22. Common Area: A common area for meetings or relaxation.

23. Corridor: A corridor.

24. Work Area: A work area equipped with tables and a variety of research instruments. The orbital radio for the outpost is here, but it is completely destroyed.

25. Quarters: Living space.

26. Storage: A storage area.

27. Quarters: Living space.

28. Storage: A storage area.

29. Airlock: A standard airlock.

30. Locker: As above.

31. Power Plant: As above.

32. Storage: This area is used to store vehicle parts and tools.

33. Garage: The vehicle storage and maintenance area. The outpost has two Rugged Rover ATVs and four Tough Buggy jeeps. At the start of the adventure, Keck will have one of the Rugged Rover ATVs.



Bunker Map

The bunker is located one hundred kilometers from the outpost in an area that is devoid of other structures (it was constructed in what was then an isolated wilderness area). The research team, as per standard procedure, tagged it with a beacon device to mark its location and to claim it for the company.

The exterior of the bunker has been scoured by centuries of sandstorms, but remains intact. Seems strong, yet foreboding-much like an ancient tomb. Investigators who have seen the pyramids of Egypt will make comparisons to those ancient structures.

The bunker was constructed by an alien species and, as such, it will seem alien to the investigators. However, the designs follow the same sort of logic and principles that humans use, so it will not seem disturbingly alien in that regard.

Bunker Level 1

The first level of the bunker was designed to generate a damping field to hide the life energy of the sleepers within from the converted. Some of the mechanisms still function, drawing energy from the sun. If the bunker's structural material is examined by someone with Physics or Chemistry skill and a skill roll succeeds, it will be revealed that the material is similar to the material used in the inner shell of human starship hulls. This is because they served the same purpose-to conceal life energy.

The bunker was unlocked centuries ago by Ka-Sho-Abrin and, although the doors closed behind him, they remained unlocked. The research team put metal plates over the locks to prevent anyone from accidentally locking them. The bunker is designed to stand up to massive damage, but could be cut into using the Portland's lasers.

The interior doors within the bunker are unlocked.

1. Damper Systems: The interior of this chamber contains some dust as well as scattering of research equipment left behind by the team. Some of the machinery in the room still functions. Examination of the machines using Electronics will reveal that they generate an energy dampening field. If they are examined by someone who has Gate System Operation skill, she will recognize the technology as being very similar to the damping fields used on human starships.

There is an open trap door set in the floor. Instead of a ladder, there is a metal pole. The research team put cable ladders (like rope ladders, but using cables) in place to use, although they did slide down the poles.

Bunker Level 2

The second level of the bunker contains the power plant and battery systems.

1. Batteries: These are high capacity, self regenerating batteries. Studying them will provide some improvements to human battery systems.

2. Walkway: This is a walkway between the areas. The doors seal air tight, creating an airlock (the bunker was constructed using some military hardware, including doors designed to keep out biological and chemical weapons). The doors are open.

3. Control Systems: This area contains the control systems for the power systems. The control systems are still functional.

4. Walkway: A walkway.

5. Batteries: As above.

Bunker Level 3

1. Hibernation Area: This area contains forty hibernation devices. Each of the devices is shielded with the damping material used to dampen the bunker. This was to further hide the sleepers from the converted. This material greatly retarded Ka-Sho-Abrin's life drain, but did not

prevent it. Twenty two of the devices are still operational, but the readouts on each one indicate that the occupants are dead (while the symbols are alien, the flat lines send a universal message), Inside each device is a dead alien of varying ages and sexes (male and female). The hibernation devices were supposed to awaken the sleepers, but were also programmed to maintain the hibernation on anyone who died (so as to not leave the survivors with decayed remains to deal with). Since all the sleepers “died”, the devices never opened.

Each device has a monitor screen that displays the alien within. The bodies are well preserved by the functional hibernation systems, but seem oddly shrunken-as if the life had been taken from them. Each hibernation device has a storage area holding clothing, an assortment of tools, alien manuals printed on metal pages, and a metal disk with a single alien symbol on it (the religious symbol of the aliens).

If the investigators open a functioning hibernation device, they will find out something terrible. While the aliens were killed by being drained by Ka-Sho-Abrin, they were also converted by this process. The shielding on the devices prevents them from tapping into the life energy of living creatures around them, but once a device is open, a converted alien will drain life from any investigators within range. If it revives, it will attack the investigators in order to get more life energy.

2. Control Systems: This area contains the controls and mechanisms for the hibernation devices. The systems are still functional. The investigators can use Electronics and Computer Use to try to figure out and operate the systems (since the systems are alien, they will be difficult to figure out). If the investigators blindly use the controls, they might turn off some of the systems or even accidentally open the hibernation devices.

Bunker Level 4

1. Hibernation Area: This hibernation area is basically the same as that on level three except that Twenty six of the hibernation devices are still functioning. There is a discolored spot on the floor where Ka-Sho-Abrin’s body rested for centuries. When the investigators arrive, he will have left the bunker and will be walking towards the outpost. A video camera and various pieces of equipment the graduate students dropped remain on the floor. The memory in the video camera records the students going through the bunker and their encounter with Ka-Sho-Abrin’s remains. While it was facing away from the door when Clay and Harn arrived, there is an audio record of what happened. The memory also shows Ka-Sho-Abrin staggering to his feet and shambling from the room.

2. Control Systems: This is similar to the control system chamber on level three. The bodies of Clay and Harn are on the floor. They are still wearing their re-breather masks and their coms. They appear dead, but have been converted and can drain life energy (see below). If they revive, they will attack the investigators.

Action Part One: The Reed

The following provides a guide to the running the action involving the Reed

Arrival

The Portland will gate into the system at optimal gate range (three planetary diameters from Richard’s World). The ship’s communication systems will pick up an automatic, battery powered distress signal from the Reed: “This is the Edgar J. Reed. There is an emergency situation. Please render assistance. This is an automated signal.” The signal repeats through the



common human languages and is on an endless loop.

The ship's scanners will pick up the Edgar J. Reed orbiting the planet. The vessel is spinning slowly, showing that something is wrong with her. She is currently in a decaying orbit and will, if nothing is done, hit the planet in sixteen days.

Magnified images of the Reed will show that her starboard engine is badly damaged with the hull plating bent outwards (indicating an internal cause). Her drone launch bay door is open and both of her shuttles are gone (one is normally kept on the surface). Her emergency lights are active.

The Reed will not respond to any communication attempts. There will also be no reply from the outpost on the planet.

The Portland's sensors will also detect two small objects in roughly the same orbit as the Reed. Magnified images of the objects will reveal that they are human bodies.

When the Portland moves closer, the ship sensors will be able to discern that the Reed has no energy signature, indicating that her systems are offline.

Sloan will want to recover the bodies and board the Reed. Her main goal at this time will be to determine what has happened to the ship and crew. If the investigators ask about any danger presented by the Reed, she will point out that the ship has no turrets and that she was not known to be carrying any drones.

Bodies

The recovery of the bodies will be fairly easy. Once the Portland matches their course and velocity, the bodies can be grabbed by someone doing an EVA, although seeing them requires a Sanity check (0/1D3 Sanity point loss). cursory examination of the bodies will reveal that they died due to vacuum exposure. The two bodies are those of Chun and Holstein.

If the bodies are examined more carefully using the medical equipment aboard the Portland, use of the Medicine skill will reveal some abnormalities (roll for each type). First, the cells in general and the nerves in particular show unusual distortions. Second, the cells and organs show signs that indicate the bodies had died and then had been revived. Third, the cells were regenerating even as they were dying in the vacuum. It was as if each body was repairing itself rapidly as the vacuum was killing it. It is clear, however, that the vacuum won. The Portland's equipment is not extensive enough to provide further information.

Other than these abnormalities (and being dead), the bodies are normal. Their genes are unchanged and there are no signs of other physical changes.

Onboard the Reed

Through the use of successful Pilot skill rolls, the Portland will be able to match courses with the Reed. Given that the Reed is spinning, the safest way to enter the vessel is via the large drone launch bay door, which is open. Getting onboard safely requires successful use of Low/Zero Gravity Operations. A normal failure will mean that the investigator missed the bay door, but can try again. A roll of 00 means that the investigator has failed in a spectacularly embarrassing and painful manner and has taken 1D6 points of damage (armor does not block this damage). The investigator will also be thrown away from the Reed and will need to maneuver back to her to try again.

Conditions on the Reed

When the investigators arrive on board the Reed, they will find that her artificial gravity is off. They will also find that the drone launch, storage and repair areas are all in vacuum.

The launch doors can be manually closed (using a hand crank) as can the lift doors. The crew lift won't work without power, but the doors can be forced and the investigators can move about via the elevator shaft.

Restoring the artificial gravity and atmosphere will require making repairs to the ship's power systems. This must be done in the port engineering access. If the investigators examine the port engineering access area, they will find, by successfully using Electronics, that the power systems have been intentionally overloaded. Fortunately, the parts needed to make basic repairs are on board.

Getting the power systems back in operation will require 1D4 hours of work as well as successful use Mechanical Repair, Electronics and Electrical Repair. When the repairs are complete, the Reed will have partial power (enough for life support, gravity and to close the launch bay and lift doors).

Getting the Reed's remaining drive nacelle back in operation will require another 1D4 hours as well as successful use of Computer Use (to undo the programming damage done by Rhodes) and Electronics. Getting the drive back in operation will enable a pilot to stabilize the Reed and move her into a better orbit.

The body of Keller is floating in the drone storage bay on Deck Four. Her vacuum suit is shredded and her body is full of shrapnel from the explosion. Seeing the body requires a Sanity check (0/1D3 Sanity point loss) Examination of the body will reveal the same sort of abnormalities found in Chun and Holstein.

Pieces of John Rhodes are splattered about in the ruins of the starboard drive. Examination of the pieces will reveal that the abnormalities found in the other bodies are not present in his remains.

Robots

The two cargo robots onboard the Reed are military surplus infantry units that saw action during the Clarkston Civil war. Since they were designed to operate as soldiers and use human equipment, they are humanoid in shape. Prior to being sold as surplus their integrated weapons and classified systems were removed. As a safety precaution, their military protocols were removed. However, the Captain of the Reed had the protocols and some of their military skills restored, just in case.

The robots are controlled by basic AI systems that give them a modest degree of flexibility in terms of actions. While they are initially unarmed, they can pick up and use weapons. They can also deal significant damage with their hands.

While they have been equipped with spotlights, their vision does include light intensification and thermal imaging. Since they have been refit as cargo handling robots, they are quipped with sticky feet as well as a maneuver packs that allow them to operate effectively in zero gravity.

John Rhodes did not have time to provide them with full mission programming. They are set on active patrol and guard mode. As such, they will attack anyone they encounter who does not know their command phrases. The keeper will need to decide when the investigators encounter the robots. They two robots are patrolling separately, but will radio each other when one encounters the investigators.

Cargo Robots

STR: 18 STU: 16 SIZ: 18 INT: 3

DEX: 10 EDU: 8

HP: 17 Move 8 DB: +1D4

Armor: 16 points.

Skills: Pistol 40%, Rifle 65%, Handle Cargo 40%, Listen 45%, Low/Zero Gravity Operations 50%, Spot Hidden 45%,

Weapons: Fist 50% 1D6+1D6.

Action Part Two: The Outpost

The following provides a guide to running the action involving the outpost.

Radio Contact

At the start of the adventure, the remaining team members and Reed crew will be in the outpost.

After the Reed has been investigated, Sloan will want to land on the surface to see what has happened at the outpost. She will suggest an initial flyover before landing. If the investigators agree, they will see that the outpost looks intact and that the two shuttles from the Reed are landed at the shuttle field. They will also see that the fuel tanks at the field have been blown up.

When the Portland overflies the outpost, it will be noticed by Keck and the converted people within the outpost. The people in the outpost will run to the vehicle bay and the shuttles to use the radios in the vehicles. Keck, who is living in the Rugged Rover ATV, will use the radio in that vehicle to make contact. Keck will try to warn the investigators while the converted people will try to convince the investigators that Keck went insane and turned against them.

Keck will start with the following: "Don't land at the outpost! This is Dr. Keck! The others have been changed! They will try to kill you! Don't land there!" She will seem quite agitated, but will have a consistent story about what happened. If the investigators express doubt, she will tell them to land away from the outpost and then check out the bunker. She will warn them to be very careful about the fourth level because "whatever happened to the graduate students, happened there."

Tumlen, who is the most persuasive and clever of the group, will initially do the talking. She will say that Keck killed Clay and Harn in the bunker. She will claim that it might have been something in the bunker

that affected her and will try to convince the investigators to stay away from the bunker. She sincerely wants them to stay away from the bunker-she wants the investigators' life energy for herself and she is also worried they might learn too much there, if they do manage to survive.

Believing that the investigators almost certainly went to the Reed, Taggart will join the conversation and say that Chun, Holstein and Keller also went mad when everyone returned to the Reed. In the ensuing conflict, John Rhodes, Chun, Holstein and Keller were killed while the Reed was badly damaged. Taggart will say that the survivors had to return to the outpost and found that Keck had destroyed the communication system.

Dr. Knight will join in the conversation and say she thinks that Keck might have been exposed to a biological agent in the bunker. She will add that Keck had recovered a small machine from the bunker and that Keller had examined it before it was picked up by Chun and Holstein. She will add that the machine was probably flushed out of the ship when it was exposed to vacuum. Dr. Knight will make a plea for the investigators to avoid hurting Keck because she "obviously is not in control of herself."

The conversation will go on until the investigators decide to take action.

Meeting Keck

If the investigators agree to meet Keck, she will tell them that she will reveal her location only if they agree to immediately fly to her. She will say that if she tells them where she is, the others will head there to get her.

If the investigators agree, she will drive 10 km from the abandoned outpost and wait for them. She will do this because she thinks she might have to flee back to the outpost and would rather not have anyone else know its location. If they show up, she will walk

out to meet them. If they try to kill her, she will try to kill them right back.

She will agree to be tested by them and allow them to keep guns pointed at her while they do so. It will be found that she is normal. Once they accept her, she will join forces with them. She will urge them to simply destroy the outpost with the Portland's weapons and then seal the bunker off. She is a natural survivor and will do what it takes to live through this.

Going to the Outpost

The converted people are driven by their hunger and new desires. What remains of their humanity plagues them with guilt about what they have done and makes them feel disgust about what they desire to do.

Their first goal is to lure some of the investigators to the outpost. Their plan is to convert a few of the investigators and then use them to get on board the Portland. They hope to then take over the ship and return to civilization and thus gain access to unlimited food.

When confronting the investigators, the converted will try to avoid using weapons. They will prefer to physically overpower the investigators, drain them and convert them.

The main problem the converted face is their overpowering hunger. They know that in the presence of the unconverted, they cannot control their hunger and will have to attack them. This is why their plans hinge on luring the investigators into the outpost.

The converted people do not initially know that their hunger is proportional to how "full" they are of life energy. If they are able to figure this out, they might decide to take advantage of that fact. If they discover this early enough, they might elect to "donate" energy to Tumlen so she can get on board the Portland without attacking anyone. If they discover this later, when they are desperate, Tumlen might decide to simply take the energy she needs. The other

graduate students and the support team will side with her against the Reed crew, should it come to that.

If the converted succeed in their plan to take the Portland, they will cause extensive damage when they return. Eventually, the authorities will deal with the situation, but many people will die.

Waiting

The investigators might decide to wait and consider the matter. Keck can scavenge enough supplies to last three months, so she is not in a great hurry.

The converted have enough supplies to last them a year, but they face another time limit. Each day they go without feeding they will grow weaker and hungrier. Eventually, they will be driven by their hunger to act out of desperation. They will turn against each other and eventually be driven to try to attack the investigators even if they stand no chance of success.

Ka-Sho-Abrin is another factor. After he drains the life energy from the students, he will gain enough energy to move again. His mind will not return, but his hunger will remain and drive him to leave the bunker. Once he is outside the bunker, he will sense the presence of life energy and will shamble towards it. He will seek the strongest concentration of life. The Portland's shielded hull will block his sense, so he will most likely be drawn to the outpost. His actions are detailed in part three, below.

Action Part Three: The Bunker & Ka-Sho-Abrin

The investigators will probably decide to investigate the bunker. There are two main dangers in the bunker: the converted aliens and the two scientists.

The Aliens

If the investigators open one or more of the hibernation devices, then they will

discover that the aliens within them have been converted. Any freed alien will begin draining life energy from the investigators and attack them as soon as it is able.

Converted Aliens, Lesser Independent Race

Though roughly human sized, the aliens are quite non-human. An alien's head is a fleshy disk with eight eyes evenly spaced around it. In the center of the top of the disk is a mouth like opening with two sets of teeth and three long, tentacle like tongues. The body is a shaped somewhat like an elongated eggplant and has four evenly spaced tentacles that end in three small tentacles. Beneath the torso is a thick disk that contains the being's two sets of pelvic bones as well as the excretory and sexual organs. Four legs, which vaguely resemble spider legs, extend from the disk. The aliens come in various colors, ranging from pale gray to a rich red color.

In their converted state, they have special abilities that are described below in the section on the converted.

Converted Aliens, Tragic Undead

<i>Char</i>	<i>Rolls</i>	<i>Averages</i>
STR	2D6	7
CON	3D6	10-11
SIZ	2D6+6	13
INT	2D6+6	13
POW	3D6	10-11
DEX	3D6+3	13-14
Move 8		HP 12
DB		+0
Weapons: Tentacles 50% 1D3+DB, Kick 25% 1D6+DB, Grapple 25%		
Armor: None		
Spells: None		
Sanity Loss: No sanity loss to see a converted alien.		

Clay & Harn

If the investigators go to the fourth level and encounter the bodies of Clay and Harn, these two converted scientists will attempt to steal their life energy.

Dr. Wilbur Clay 42, Xeno-Archeologist

STR: 12 CON: 12 SIZ: 12 INT: 16
POW: 12 DEX: 12 APP:12 EDU:19
SAN: 64 HP: 12 DB: +0

Weapons: Fist 50% 1D3+0 Kick 25%
1D6+0 Grapple 25%

Description: Dr. Clay is a thin man who has a close trimmed beard and is going bald. He has brown eyes and his remaining hair is black. He is a talented xeno-archeologist, but is now driven only by his need for life energy.

Abilities: See below.

Dr. Janet Harn Clay 35, Xeno-Archeologist

STR: 12 CON: 13 SIZ: 13 INT: 15
POW: 10 DEX: 13 APP:13 EDU:18
SAN: 50 HP: 13 DB: +1D4

Weapons: Fist 50% 1D3+1D4 Kick 25%
1D6+1D4 Grapple 25%

Description: Dr. Harn is a tall woman who has short brown hair and blue eyes. Her new status as one of the converted has given her the drive and ambition she lacked in her previous life. Unfortunately, this new drive is to steal the life from others.

Abilities: See below.

Ka-Sho-Abrin Walking

Feeding upon the graduate students revived Ka-Sho-Abrin and enabled what remains of him to move about and seek life. Since he can sense life, he will head in the direction of the closest living things. When he encounters a living being (converted or not), he will rush mindlessly to attack.

The investigators can hide from him inside the Portland or in the bunker. As noted below, he cannot sense living creatures through the hull of the Portland or through

the walls of the bunker. If the investigators stay in the Portland, Ka-Sho-Abrin will eventually reach the outpost and will

Since Ka-Sho-Abrin has such a high POW and can drain life energy, he will pose a significant threat should the investigators decide to fight him up close. The investigators' best strategy would probably be to lure him into an open area and simply vaporize him using the Portland's lasers.

Ka-Sho-Abrin, Ancient Scientist

STR: 8 CON: 16 SIZ: 14 INT: -
POW: 30 DEX: 13 APP:- EDU:-
HP: 15 DB: +0

Magic Points: 15 to begin with.

Weapons: Tentacle 50% 1D3+0 Kick 25%
1D6+0 Grapple 25%

Sanity Loss: Seeing Ka-Sho-Abrin's shambling form costs 1/1D6 Sanity points.

Description: Ka-Sho-Abrin looks like the others of his race. Unlike the others, his body seems oddly broken and appears as if it has been patched back together with unnatural energy (which it has). He is a dull gray in color and his eyes are dark and lifeless, like that of a mindless killer.

Although he is alien, he seems especially wrong, thus seeing him costs Sanity points.

After Ka-Sho-Abrin "died", his energy underwent a strange transformation that fundamentally altered the nature of his conversion. One major effect of this change is that when he completely drains another living creature, their life energy is converted and they can, in turn, feed upon life energy.

Ka-Sho-Abrin's new mode of existence provides him with terrible abilities. First, if he loses all his life energy (Magic points) he will become inactive. However, in this state he can drain the life energy of any creature within 1 meter per point of POW he has. This attack matches his POW against the POW of the target on the Resistance table. If Ka-Sho-Abrin wins, he drains 1D8 Magic points from the target. Each round, this

process begins with the being with the lowest POW and moves to the next lowest and so on. Ka-Sho-Abrin will drain Magic points from each creature within range until his Magic points are fully restored or the targets run out of Magic points. If a target runs out of Magic points, it will seem dead, but will actually be in the initial state of conversion. This draining ability is impeded by the walls of the bunker and the hulls of human starships. While he can drain a tiny amount of energy through such barriers, they effectively block his ability to drain energy. As such, the bunker and the Portland can be used as refuges against him. If he gets inside the Portland, he can drain within the vessel. Inside the bunker he can drain through open doors, but not through the walls or closed doors.

Second, when he has at least 1 Magic point, he will revive and be able to move again. If his Magic points are not full, he can drain them from others by touch. When he touches a target, he matches his POW against the target. If he succeeds, he drains 1D6 Magic points. If he drains a target to 0 Magic points, the target is converted. If he gets the chance, he can "feed" on a life energy battery (used to power the Markelson Gate System) by draining Magic points from it.

Third, he can sense the life energy of creatures. This ability allows him to know the general direction to living creatures. This ability has a range of 500 KM. The bunker and human starship hulls block this ability, so those on the Portland or in the bunker will be invisible to him-provided he is not inside.

Fourth, he can use his Magic points to sustain his body. When his hit points are exhausted, he will then start taking damage to his Magic points. When they are exhausted, he will become inactive. He can then drain life energy once more, as specified above. He can also use his Magic

points to heal his body. Once his Magic points are fully restored, he can expend any excess he gains from draining others to restore his hit points (1 hit point per magic point). He no longer heals naturally and must rely on stolen Magic points to repair his body. When he initially revived, he had to expend Magic points to repair his body. If his Magic points are exhausted after his body has been “killed”, then he is permanently destroyed.

Fifth, each day he must expend one Magic point to remain active. If he runs out of Magic points, he stops moving and becomes inactive. He can last in this state for one year for each point of POW he has. He can, of course, drain living creatures that come within range. He does not regenerate Magic points on his own.

Sixth, if he reaches his capacity in Magic points, he will simply stop moving. If he is threatened or attacked, he will respond.

The Converted

The aliens and students drained by Ka-Sho-Abrin became the first of the new converted. The converted have the following abilities and problems.

When a living creature is first drained to zero Magic points, it will fall into a state that seems almost indistinguishable from death. However, the cells of the creature are sustained by a strange energy. Such a creature will remain in this state for 1 day per point of POW and then actually die. Damage to the body can also kill it normally. If a converted body is put into hibernation or similar sort of life suspension, it can be sustained indefinitely.

When a converted creature is at zero Magic points, it can drain energy of any unconverted living creature within 1 meter per point of POW he has. This attack matches his POW against the POW of the target on the Resistance table. If it wins, it drains 1D3 Magic points from the target.

Each round, this process begins with the being with the lowest POW and moves to the next lowest and so on. A converted being will drain Magic points from each creature within range until its Magic points are fully restored or the targets run out of Magic points. If a target runs out of Magic points, it becomes one of the converted. This draining ability is impeded by the walls of the bunker and the hulls of human starships. While he can drain a tiny amount of energy through such barriers, they effectively block his ability to drain energy. As such, the bunker and the Portland can be used as refuges against him. The walls and doors of the bunker provide full protection against this attack. The interior walls of the Portland are not shielded and will not block this ability.

Second, when it has at least 1 Magic point, it will revive and be able to move again. If its Magic points are not full, it can drain them from others by touch. When it touches a target, it matches its POW against the target. If it succeeds, it drains 1D3 Magic points. If it drains a target to zero Magic points, the target is converted. A converted being can drain Magic points from another converted being in this manner. A converted being can “feed” on a life energy battery (used to power the Markelson Gate System) by draining Magic points from it.

Third, it can use its Magic points to sustain his body. When its hit points are exhausted, it will then start taking damage to its Magic points. If it runs out of Magic points after running out of hit points, it dies completely. It can also use his Magic points to heal his body. Once its Magic points are fully restored, it can expend any excess it gains from draining others to restore lost hit points (1 hit point per magic point). A converted being heals naturally and can be treated with First Aid and Medicine.

Fourth, it must expend 1 Magic point every three days in order to remain active. If

it runs out of Magic points, it becomes inactive, but can drain them from other creatures (as above). A converted being no longer regenerates Magic points naturally.

Fifth, a converted being retains all its original abilities, skills, knowledge and personality. It eats, drinks and sleeps normally (if it did so before conversion). However, its new state gives it an ongoing hunger and terrible desires. This hunger initially only manifests itself when the converted is within draining range of an unconverted being. To resist this hunger, the converted must match its POW against 5 times its Magic point deficit on the Resistance table each round. For example, if a converted has a POW of 15 and has 10 Magic points, it has a deficit of 5 points. Hence, it must match its POW of 15 against 25 on the Resistance table. If it succeeds, it can act as it wishes. If not, it must attack the creature.

Sixth, a converted being can transfer its Magic points to another converted being by touching it and allowing its energy to flow into the other being. Doing this transfers 1 Magic point each round. This is used to revive beings that have been drained of life.

When a converted being's Magic points get low, it will feel a strong hunger and desire to feed. If reduced to 3 Magic points or less, it will be driven to take Magic points from any source, even other converted beings.

Sanity Costs

A sane being that has Magic points drained by Ka-Sho-Abrin or one of the converted will lose 1/1D4 Sanity points. While being repeatedly attacked is unsettling, there is a limit to the mental damage done. To be specific, the most an investigator can lose is a total of 4 points. If a significant time period goes by between attacks, the Sanity loss can begin again.

Being converted costs the victim 1D4/1D10 Sanity points. Feeding on other creatures costs the converted 1/1D4 Sanity points. Converting another being costs the converted 1/1D6 Sanity points. Living as one of the converted gradually erodes Sanity at the rate of 1/1D4 points a day.

When a converted creature's Sanity drops to zero, it fully accepts its converted state and embraces its hunger. It will only try to resist its hunger when doing so is clearly to its advantage.

Conclusion

The adventure ends when the investigators deal with the converted and Ka-Sho-Abrin, flee or perish in the attempt.

If the investigators flee the world, it will be up to someone else to deal with the situation. The investigators should be penalized 1D6 Sanity points for their cowardice.

If the investigators are defeated and converted, they will most likely decide to return to a human world. Eventually the authorities will sort things out, but many people will die. If the keeper and players wish to walk on the dark side, the players could continue to play their converted investigators. However, this does go rather against the spirit of the game.

If the investigators deal with the converted, they should receive a 1D6 Sanity point reward. If the investigators defeat Ka-Sho-Abrin, they should receive a 1D6 Sanity point reward. The investigators will also receive payment for the mission.

If the investigators do not destroy the bunker and the aliens, they will be studied by Lee Industries and the investigators will be compensated for assisting in the recovery of a valuable find. If the investigators destroy the bunker and aliens, they might be subject to legal prosecution under the laws governing the preservation of alien finds and cultural artifacts. If the investigators can



prove that they had no choice, they will be found innocent.

If the investigators manage to capture some of the converted humans and keep them alive, the company will want to try to help them (by studying them). The investigators will receive an extra bonus for each person they manage to “save.”

Epilogue

Recovery of the technology and aliens from Richard’s world enabled Lee Industries to make several technological and medical breakthroughs. The battery and hibernation technology recovered led to the development of improved batteries as well as better medical hibernation systems, thus enabling the badly wounded to be kept alive long enough to be brought to medical facilities.

Study of the aliens provided the basis for both peaceful and military applications. By gaining greater knowledge of the nature of life energy, great improvements in medical treatments and life prolongation were developed. This knowledge also allowed the first steps towards the development of terrible new weapons-weapons that would simply take the life energy of their victims while doing no damage to structures and vehicles. Eventually, truly horrific weapons would arise from this technology: weapons capable of devouring entire worlds.

NPCs

Dr. Sarah Keck 36, Survivor

STR: 12 CON: 14 SIZ: 13 INT: 15
POW: 14 DEX: 13 APP:13 EDU:19
SAN: 81 HP: 14 DB: +1D4
Skills: Anthropology 11%, Archeology 81%, Biology 11%, Climb 40%, Conceal 25%, Dodge 36%, Drive 30%, Electrical Repair 20%, Fast Talk 15%, First Aid 50%, Geology 21%, Hide 40%, History 50%, Jump 35%, Law 15%, Library Use 55%,

Listen 45%, Natural History 20%, Sneak 40%, Spot Hidden 55%, Xeno-Archeology 81%, Handgun 40%, Rifle 45%, Knife 40%
Weapons: Armtech LR475 55% 2D6, Beretta LP-24 50% 1D10, Knife 40% 1D4+2

Description: Dr. Keck is a tough looking woman who has black hair and gray eyes. She has an assortment of scars on her arms and torso. She refused to have cosmetic surgery on the grounds that she needed them to remind her of the importance of not trusting aliens. Keck is a rather good xeno-archeologist, but her approach is now tainted by the anger that resulted from her ordeal and the treatment that followed. She is slow to trust others and is a natural survivor. She will do whatever it takes to survive, even if that requires killing.

The Converted

The converted NPCs retain the characteristics and skills they had prior to conversion. For the sake of simplicity, each converted NPC will start the adventure with Magic points equal to one half his or her POW. The keeper can adjust this as desired.

Edgar J. Reed Crew

Owen Taggart 41, Captain

STR: 14 CON: 14 SIZ: 15 INT: 13
POW: 11 DEX: 13 APP:13 EDU:17
SAN: 35 HP: 14 DB: +1D4
Skills: Accounting 20%, Astronomy 41%, Bargain 35%, Computer Use 31%, Credit Rating 25%, Electrical Repair 15%, Fast Talk 25%, Law 15%, Navigate 60%, Operate Heavy Machinery 31%, Low/Zero Gravity 40%, Operations Persuade 40%, Physics 21%, Pilot Space Ship 61%, Pilot Shuttle 31%, Psychology 15%
Weapons: Armtech LR475 35% 2D6 or Beretta LP-24 30% 1D10, Punch 50% 1D3+1D4 Kick 25% 1D6+1D4, Grapple 25%

Description: Taggert is a solid fellow who has light brown hair, a beard and brown eyes. Before conversion he was a jovial and religious fellow. Now he is struggling with guilt and horror. Of the converted, he is the most likely to try to resist attacking others.

Sally Rhodes 32, Pilot

STR: 12 CON: 13 SIZ: 12 INT: 12
POW: 12 DEX: 14 APP:13 EDU:14
SAN: 30 HP: 13 DB: +0

Skills: Astronomy 31%, Bargain 35%, Computer Use 31%, Credit Rating 25%, Electrical Repair 15%, Fast Talk 25%, Law 15%, Lowe/Zero Gravity Operation 40%, Navigate 60%, Operate Heavy Machinery 31%, Persuade 40%, Physics 21%, Pilot Space Ship 61%, Pilot Shuttle 41%, Psychology 15%

Weapons: Armtech LR475 35% 2D6 or Beretta LP-24 30% 1D10, Punch 50% 1D3+DB, Kick 25% 1D6+Db, Grapple 25%

Description: Rhodes has dark brown hair and brown eyes. She is a competent pilot. She is still deeply hurt over the death of her husband and blames Tumlen the most. Should conflict arise between the converted, she will go after Tumlen first.

Graduate Students

Thomas Goldberg 23, Graduate Student

STR: 12 CON: 12 SIZ: 13 INT: 14
POW: 12 DEX: 11 APP:11 EDU:14
SAN: 30 HP: 13 DB: +1D4

Important Skills: Accounting 20%, Anthropology 21%, Archeology 21%, Bargain 15%, Biology 21%, Chemistry 11%, Drive 40%, Fast Talk 25%, Geology 41%, History 60%, Library Use 75%, Natural History 40%, Occult 45%, Persuade 35%, Psychology 25%, Xeno-Archeology 51%

Weapons: Armtech LR475 35% 2D6 or Beretta LP-24 30% 1D10, Punch 50% 1D3+1D4, Kick 25% 1D6+1D4, Grapple 25%

Description: Goldberg has black hair and brown eyes. He has been trying to grow a goatee to impress the ladies. He is quite smitten with Tumlen and will do whatever she says. He was an accounting major in college before getting interested in the occult. This led him, in a round about way, to Xeno-Archeology. He thinks that what is happening must be supernatural in origin and he has been annoying the others with his theories about vampires.

Shali Tumlen 24, Graduate Student

STR: 10 CON: 11 SIZ: 10 INT: 16
POW: 16 DEX: 14 APP:17 EDU:14
SAN: 60 HP: 11 DB: +0

Skills: Anthropology 11%, Archeology 21%, Bargain 45%, Biology 11%, Chemistry 11%, Drive 40%, Fast Talk 65%, Geology 41%, History 50%, Library Use 75%, Natural History 20%, Persuade 55%, Psychology 56%, Xeno-Archeology 51%

Weapons: Armtech LR475 35% 2D6 or Beretta LP-24 30% 1D10, Punch 50% 1D3+0, Kick 25% 1D6+0, Grapple 25%

Description: Tumlen is an exotic beauty who has green eyes and black hair. Behind those green eyes is a sharp and powerful mind. She has a natural gift for convincing others to do what she wants, but before she was converted she followed a very rigid set of ethics she had acquired from her parents and her faith. After her conversion, she came to believe that everything she accepted before was but a lie designed to hold her back from the wealth and power she so richly deserves. She prefers to rely on her powers of persuasion rather than physical violence. She is currently the leader of the converted and enjoys the unquestioned loyalty of the

other graduate students. However, she suspects that the survivors of the Reed crew are unreliable and intends to deal with them at the first sign of betrayal.

William Chopah, 24, Graduate Student

STR: 10 CON: 12 SIZ: 10 INT: 14
POW: 13 DEX: 10 APP:10 EDU:14
SAN: 60 HP: 11 DB: +0

Skills: Anthropology 41%, Archeology 21%, Bargain 15%, Biology 21%, Chemistry 56%, Drive 40%, Fast Talk 25%, Geology 41%, History 60%, Library Use 75%, Natural History 40%, Persuade 35%, Psychology 25%, Xeno-Archeology 51%
Weapons: Armtech LR475 35% 2D6 or Beretta LP-24 30% 1D10, Punch 50% 1D3+0, Kick 25% 1D6+0, Grapple 25%
Description: Chopah is a small man of average appearance. He blends in well with crowds because of his non-descript nature. He chose to go into Xeno-archeology because his parents are in the field. They both work for Lee Industries and they helped get the grant money for the expedition. While he is loyal to Tumlen, he sincerely wishes that he had chosen a different field of study.

Lo Winston, 27 Graduate Student

STR: 16 CON: 14 SIZ: 15 INT: 13
POW: 13 DEX: 14 APP:12 EDU:14
SAN: 45 HP: 15 DB: +1D4

Important Skills: Archeology 21%, Biology 21%, Chemistry 11%, Drive 40%, Fast Talk 15%, Jump 35%, Geology 21%, History 30%, Library Use 65%, Natural History 40%, Occult 45%, Psychology 25%, Swim 65%, Throw 75%, Xeno-Archeology 51%
Weapons: Armtech LR475 35% 2D6 or Beretta LP-24 30% 1D10, Punch 50% 1D3+1D4, Kick 25% 1D6+1D4, Grapple 25%, Baseball Bat 45% 1D8+1D4
Description: Winston is a large man who has blonde hair and blue eyes. He is quite fit,

having played baseball in college. He also was on the swim team. Naturally, he finds the lack of swimming pool quite unpleasant. He tried to get the others to play baseball, but playing in the dust proved to be far too unpleasant. Winston is loyal to Tumlen and hopes that she will be smart enough to get them out of the situation.

Support Team

Ted Younger 31, Shuttle Pilot

STR: 13 CON: 13 SIZ: 13 INT: 11
POW: 13 DEX: 14 APP:13 EDU:14
SAN: 45 HP: 13 DB: +1D4

Skills: Astronomy 31%, Bargain 25%, Computer Use 31%, Credit Rating 25%, Electrical Repair 15%, Fast Talk 25%, Law 15%, Lowe/Zero Gravity Operation 40%, Navigate 60%, Operate Heavy Machinery 31%, Persuade 40%, Physics 21%, Pilot Space Ship 21%, Pilot Shuttle 81%, Psychology 15%

Weapons: Armtech LR475 35% 2D6 or Beretta LP-24 30% 1D10, Punch 50% 1D3+DB, Kick 25% 1D6+Db, Grapple 25%
Description: Younger is an average size man who has long hair (kept in a pony tail) and a beard. He wears sun glasses at all times and fancies himself a free spirit. He is not happy about the situation, but is counting on Tumlen to find some way out of it. He was friends with Chun and is sorry that she is gone. He is becoming friends with Sally Rhodes and will stick with her, should trouble arise.

Dr. Laura Knight 33, Medical Doctor

STR: 11 CON: 12 SIZ: 11 INT: 15
POW: 13 DEX: 15 APP:13 EDU:18
SAN: 45 HP: 14 DB: +0

Important Skills: Accounting 30%, Biology 61%, Chemistry 41%, Conceal 35%, Drive 30%, First Aid 60%, Hide 30%, Law 25%, Library Use 65%, Medicine 76%, Latin 11%, Pharmacy 71%. Psychoanalysis 41%, Psychology 45%, Sneak 25%

Weapons: Armtech LR475 35% 2D6 or Beretta LP-24 30% 1D10, Punch 50% 1D3+DB, Kick 25% 1D6+Db, Grapple 25%
 Description: Dr. Knight has black hair and pale blue eyes. She started off as an idealistic doctor, but soon became enamored of her own medicines and became an addict. She hoped to find redemption on this expedition, but instead found a new sort of hell. She was pleased to find that her drugs still work fine, despite her converted status. She now spends most of her time in a pharmaceutical haze.

The Portland Team

The following characters are the Portland Team. Each player can select which character s/he wishes to play. Naturally, the players can change the names, personalities and genders as they see fit. Alternatively the players can generate their own characters for the adventure. They should, of course, create characters that can fulfill the required rolls. If there are more players than pre-generated characters, then additional characters will have to be generated and assigned rolls.

Jeff Dresden 37, Captain

STR: 14 CON: 14 SIZ: 14 INT: 13
 POW: 15 DEX: 14 APP:13 EDU:15
 SAN: 75 HP: 14 DB: +1D4

Important Skills: Astronomy 31%, Bargain 35%, Fast Talk 25%, Computer Use 51%, Electrical Repair 30%, Electronics 21%, Low/Zero Gravity Operations 40%, Mechanical Repair 50%, Navigation 60%, Persuade 55%, Pilot Space Ship 71%, Pilot Shuttle 31%, Pilot Jet 31%

Weapons: Handgun 30%

Description: Dresden is a solidly built man of average height. He has black hair and a short beard. He was a scout pilot and served as a peacekeeper for the CMA after the Clarkston Civil War. He is calm under pressure and very concerned about the safety

of his team members. While he does understand the need to operate a profitable business, he is in it for the excitement and adrenal rush provided by missions to exotic places. He still holds the reserve rank of Lieutenant Commander in the Navy and takes his responsibility to the military seriously. As such, he will act decisively against any possible threats to humanity. His wife, Ashleigh, was also a peacekeeper after the war. She was killed during a resurgence of the fighting. Since then, Dresden has remained single.

Danielle Hussein 34, Co-Pilot & Navigator

STR: 16 CON: 14 SIZ: 8 INT: 13
 POW: 14 DEX: 17 APP:15 EDU:14
 SAN: 70 HP: 11 DB: +1D4

Skills: Astronomy 31%, Computer Use 21%, Electrical Repair 30%, Electronics 21%, Jump 35%, Low/Zero Gravity Operations 50%, Mechanical Repair 40%, Navigation 85%, Pilot Space Ship 71%, Swim 85%

Weapons: Handgun 40%, Rifle 45%

Description: Hussein is a short, extremely strong woman. She is an amateur tri athlete and has competed on several worlds. She keeps her bike on board, just in case the chance to train or compete arises. She served with Dresden during the Clarkston civil war and is quite loyal to him. She is much more financially focused than Dresden, but generally thinks in terms of how extra income can help her get an even better competition bike. She has had experience in combat and hence is accustomed to danger. She regards life as a challenge that needs to be overcome. She secretly collects antique horse miniatures and thinks that no one knows about this hobby.

Rachel Li 28, Engineer

STR: 12 CON: 13 SIZ: 12 INT: 15
 POW: 14 DEX: 12 APP:13 EDU:16

SAN: 70 HP: 13 DB: +0
Skills: Biology 41%, Computer Use 61%,
Draw 15%, Electrical Repair 81%,
Electronics 81%, Gate System Operation 71,
Library Use 55%, Mechanical Repair 80%,
Medicine 21%, Physics 31%.
Weapons: Handgun 30%
Description: Li is an average sized woman
who has long brown hair, one blue eye and
one green eye. She is learning how to draw
and expects the other team members to pose
for her, preferably without clothes on. She is
rather quirky, but is an expert in her field.
She served with Dresden's wife during the
peacekeeping operation and was with her
when she was killed in action. Since they
were best friends, Ashleigh told Li to keep
and eye on her husband, and she has been
with him ever since.

Dr. Rico Mendez 35, Medical Doctor

STR: 12 CON: 12 SIZ: 13 INT: 16
POW: 13 DEX: 15 APP:12 EDU:19
SAN: 60 HP: 13 DB: +1D4
Skills: Accounting 30%, Biology 61%,
Chemistry 41%, Drive 30%, First Aid 60%,
Hide 30%, Law 25%, Library Use 65%,
Medicine 86%, Latin 11%, Pharmacy 71%,
Psychoanalysis 61%, Psychology 45%,
Weapons: Pistol 35%, Rifle 45%
Description: Dr. Mendez served during the
Clarkston civil war as a combat doctor.
Although he tried to stick with the
Hippocratic oath, he was occasionally forced
to shoot people. But, as he always says, he
was always able to save their lives
afterwards. Mendez met Dresden after the
war and the two men became friends. Eager
to get away from the site of so much pain
and suffering, he signed on with Dresden as
the ship's doctor. Mendez is a good doctor
in the classic sense-he is dedicated to the
well being of his patients and is very
empathetic. He enjoys working as part of
Dresden's team and the opportunity it gives
him to help people.

Rufus Ruck 29, Gunner

STR: 14 CON: 14 SIZ: 15 INT: 11
POW: 12 DEX: 12 APP:10 EDU:12
SAN: 60 HP: 15 DB: +1D4
Skills: Dodge 34%, First Aid 50%, Hide
40%, Listen 55%, Mechanical Repair 70%,
Sneak 40%, Low/Zero Gravity Operations
60%, Gunnery 85%
Weapons: Rifle 55%, SMG 45%
Description: Ruck is a quiet man who enjoys
watching videos of old operas. He has red
hair and brown eyes. He served as a gunner
with Dresden and stuck with him after
mustering out. While he professes a peaceful
disposition, he is rather fond of "pushing the
button and making things go away." Before
taking a position as a gunner, he served as a
combat specialist. While he is skilled with
the smaller guns, he much prefers the big
ones. Plus, as he says, "you get to sit down
when you use the big guns."

Henry Dakota 25, Combat Specialist

STR: 14 CON: 15 SIZ: 15 INT: 11
POW: 13 DEX: 13 APP:14 EDU:12
SAN: 65 HP: 15 DB: +1D4
Skills Dodge 36%, First Aid 40%, Hide
50%, Listen 65%, Mechanical Repair 30%,
Sneak 50%, Low/Zero Gravity Operations
40%, Martial Arts 21%
Weapons: Rifle 85%, Pistol 40%, SMG
65%, Fist 70% 1D3+1D4
Description: When his head is not shaved,
he has light brown hair. He has brown eyes.
During the Clarkston civil war he served in a
Special Forces unit and had a very
impressive service record. When the war
ended, he tried to go back to school and
return to civilian life. However, he found
school boring and civilian life far too
constraining. He saw an advertisement
placed by Dresden for a combat specialist
and took the job. Dakota is somewhat prone
to solving problems with violence. But, as
he points out, "sometimes violence is the

answer.” While nominally a civilian, Dakota refers to Dresden as his CO and acts accordingly.

Andrea Sloan 33, Agent

STR: 14 CON: 15 SIZ: 13 INT: 16
POW: 16 DEX: 15 APP:14 EDU:16
SAN: 80 HP: 14 DB: +1D4

Important Skills: Bargain 35%, Dodge 40%, Fast Talk 45%, First Aid 50%, Geology 11%, Hide 30%, Library Use 45%, Listen 45%, Mechanical Repair 40%, Sneak 30%, Low/Zero Gravity Operations 40%, Martial Arts 31%, Persuade 55%, Psychology 35%,Xeno-archeology 51%

Weapons: Handgun 50%, Rifle 45%, SMG 45%, Fist 70% 1D3+1D4, Kick 45% 1D6+1D4, Grapple 45%

Description: Sloan has short blonde hair and blue eyes. She received a B.S. in xeno-archeology and then joined the military during the civil war on Clarkston. Her parents, older brother and younger sister were killed during the fighting, leaving her alone and with a deep hatred of war. She was decorated several times and was promoted to the rank of Captain. After the war ended, she returned to school and completed her M.S. She was then hired by Lee Industries and has been involved with several successful expeditions. She is still on reserve status with the Colonial Military Authority. Having been shot at on numerous occasions, she always wears Overarmor armored clothing and carries a silenced Sig Sauer pistol. While it is natural to suspect that she is a corporate loyalist who will do anything, sell out anyone and act with out any compunctions for the profit of Lee Industries, this is not the case. While she is loyal to her employer, she has always acted in accord with her excellent principles and will continue to do so throughout her career.

Players' Handouts

Handout #1

From "The Danger of Commercialization" in the Journal *of Xeno-Archeology* by Dr. Marvin Shely.

...While Lee Industries has contributed greatly to xeno-archeology, it has contributed greatly to the commercialization of the field. This has led the researchers it employs to take more risks than should be taken and has led to some serious and deadly consequences.

One noteworthy incident occurred in the Temsha asteroid belt. A research team found a derelict alien craft on one of the asteroids. Rather than informing the authorities of the find immediately, the team attempted to board the vessel. The ship proved to still have at least one active weapon system and the research team's ship was badly damaged. Fortunately, no one was killed...

...Perhaps the most tragic incident involving the company occurred on one of the moons of Langston IV. A research team on that moon found what later proved to be a chemical weapon's laboratory. Unfortunately, this fact was not determined until after the entire team has been killed by one of their finds-an extremely potent chemical weapon. This find proved quite valuable for the company, but at the cost of seventeen lives...

Handout #2

Lee Industries' Personnel, Richard's World

Edgar J. Reed Crew

Captain: Owen Taggart

Pilot: Sally Rhodes

Engineer: John Rhodes

Shuttle Pilot: Rhonda Chun

Cargo Master: Amjed Holstein

Research Team (Ground)

Dr. Wilbur Clay

Dr. Janet Harn

Dr. Sarah Keck

Graduate Students (Ground)

Thomas Goldberg

Shali Tumlen

William Chopah

Lo Winston

Support Team (Ground)

Shuttle Pilot: Ted Younger

Engineer: Bina Keller

Medical: Dr. Laura Knight

Handout #4

Information on Richard's World

Sixty years ago an automated probe entered what is now known as the Richard system. In accord with its primary mission, the probe scanned for signs of intelligent life. Finding none, it conducted a routine survey for resources and sent a data torpedo back into human space. It then departed and moved on to its next mission.

Twenty years latter, a manned mission lead by Captain Walter Richard arrived in the system. When the scout team reached the only world in the star's habitable zone, they were surprised when their sensors revealed massive structures all over the planet's surface. What they found, upon further investigation, both shocked and amazed them-the entire world seemed to be dead. No artificial energy sources could be detected, no response to their presence was forthcoming and there seemed to be no signs of life at all. Captain Richard later noted in his log that he felt he was "gazing down at a world-spanning cemetery."

After taking suitable precautions, the scout vessel sent down a landing team to investigate a promising area. They reported that the massive structures were empty of everything but dust. This dust also seemed to cover the whole world. Robotic probes confirmed Richard's impression-the world was, as far as could be determined, completely dead. Not even living bacteria were detected anywhere.

Richard reported his findings and, as per protocol, a more substantial scouting mission arrived to investigate the remains of the alien civilization. Several public and private research teams, hoping to glean secrets from the alien ruins, followed this mission. The planet proved, however, to be a bitter disappointment. Nothing was found but empty structures, dust and more dust.

Initially, some scientists speculated that the world never had life and that an alien race had come to the world to construct the structures for some unknown reason. However, examination of the world's fossil record showed that life had existed in abundance on the world prior to whatever event lead to the complete die off. Signs of historic civilizations were found that showed continuity with the most recent structures. This evidence showed that there had been life and an advanced civilization native to the world and that somehow everything had died within a relative short span of years.

One unusual fact about the world was that the research teams all reported unusual levels of illness and depression among their personal. This fact led some to speculate that whatever killed the original inhabitants might have left lingering traces. Naturally, the world was carefully investigated for pathogens, radiation and toxins. However, no environmental factors were even found. Psychologists eventually attributed the feelings to the bleak nature of the world rather than to any harmful causal agent.

The scientists continued to investigate the world in the hopes of determining what had killed everything on the planet. Numerous theories were advanced and most of these involved wars, technological disasters, or ecological disasters. However, no satisfactory theory was every found. Eventually, the theorists moved on to newer problems and Richard's world remains a mystery.

With the exception of Lee Industries, all other expeditions eventually left the planet empty handed. Lee Industries currently maintains a research outpost on the world.

In terms of its physical characteristics, the world was once very much like earth. In some ways, it still is. Like earth, it is a rocky planet with a molten core. Like earth, it has active weather patterns. It is also roughly the same size and density of earth, giving it .9 earth gravity.

The atmosphere was once a breathable oxygen-nitrogen mix. However, the absence of plant life means that humans must wear oxygen masks when on the world. Pressure suits are not needed since the atmospheric pressure is tolerable.

Naturally, the complete lack of life has had a huge impact on the world. Without plants to hold soil in place, the world has constant and massive dust storms. In this regard, the world has provided an excellent, albeit extreme, example of environmental disaster.

Players' Material

Equipment

Mission Equipment

- 1 Medical Kit per person.
- 1 Com per person
- 1 Rebreather Mask per person and 4 spares.
- 1 Vistech A23 iEnhance System per person and 2 spares.
- 1 Light Vacuum Suit per person.
- 1 Vacuum Operations Suit per person.
- 1 Maneuver Rod per person.
- 1 pair Sticky Boots per person
- 1 ShieldTech Combat Vest per person
- 4 ShieldTech Combat Armor suits
- 1 Smart Targeting System per person
- 10 BP Ammunition Packs (adaptive bullets) per BP weapon
- 1 Berretta LP-24 and 2 extra magazines per person.
- 1 HK LP-5 per and 3 extra magazines per person
- 1 Constitution Arms BP-42 Assault Rifle and 4 extra magazines per person
- 1 HK BP-15 SMG and 4 extra magazines per person.
- 1 Sig Sauer 465 and 2 extra magazines per person.

Personal Equipment

Medical Kit

A medical kit is a briefcase size container that holds a diverse selection of medical equipment and medicine. The case also contains a medical computer. Use of the medical kit confers a +10% bonus to First Aid or Medical skill and increases the amount of hit points healed with each use by 1D3.

Com

A com, which clips to the user's ear, is a combination of a personal computer and

communication system. In addition to providing a speaker and a microphone, a com can also protect images in front of the user's eyes-thus creating an interactive monitor of adjustable size. The com can also generate a virtual keyboard. Naturally, a com is equipped with a camera system, thus allowing two way video communications.

A com, like ancient mobile phones, can tap into commercial networks. They also are equipped with radio systems (20 kilometer range) for direct communication. Military versions are equipped with more channels as well as military grade encryption.

Rebreather Mask

A rebreather mask provides the user with eight hours of breathable air. The unit has an oxygen supply as well as a CO2 scrubber system (it removes the carbon, thus freeing up the oxygen). These masks are used when an air supply is needed but a vacuum or pressure suit is not.

Vistech A23 iEnhance System

These goggles provide a variety of vision enhancements. In addition to protecting the eyes from particle and glare, they also provide light intensification and thermal imaging functions. They also provide binocular magnification and basic range finding capacity.

Vacuum Suits

Vacuum suits (or space suits) are designed to protect humans from the hostile environment of space. In addition to providing protection against the effects of vacuum, they also provide breathable air and temperature regulation. While archaic designs are used by some, the modern vacuum suits of this time are comfortable to wear, light and strong.

Light Vacuum Suit

Light vacuum suit is designed for light use and as a safety measure for vehicle crews. The suit designed for comfort and mobility. A LVS protects its wearer from moderate radiation, heat, cold and vacuum. Each suit is equipped with a small chest unit that keeps the user alive. A LVS uses an advanced oxygen recycling system that can sustain the user for twelve hours, less if the wearer is engaged in stressful activities or if the environmental conditions severely tax the suit. The suit helmet is equipped with an audio and video transmitter-receiver (800 km range in space), a reactive faceplate, and lights. A LVS provides the wearer with four points of armor and is self sealing. A maneuver rod is usually attached to a LVS.

Vacuum Operations Suit

A VOS is designed for extended operations in space. It supports its wearer for twenty four hours. The suit is specially designed for work provides the user with excellent mobility. A VOS is designed to protect the user from various hazards and provides twelve points of armor. A VOS is equipped with a maneuver pack that allows the user to move about freely and also achieve speeds of up to 300 kilometers per hour. A built in power supply for tools is standard as is an onboard computer.

Maneuver Rod

A maneuver rod is mostly intended for emergency use in space. It is a rod about the size of a track baton. One end is a CO2 “gun” that can be used to push the user. The rod holds a CO2 cartridge good for 30 one second bursts. The other end of the rod has a controllable gripping system (based on the gecko’s foot) that is attached to 20 meters of ultra strong wire.

Sticky Boots

Sticky boots have specially designed soles that can firmly grip any surface, yet let go when the wearer needs to move. While it takes some time to get accustomed to the boots, they are fairly easy to use once they are mastered. The boots are used in low/zero gravity situations to enable the wearer to walk on a surface. They are also useful in dealing with weapon recoil. If the wearer can place her feet on a stable surface, she is treated as braced when making attacks.

Weapons & Armor

Overarmor Defensive Wear

Overarmor manufactures normal looking clothing that provides armor protection for the wearer. The clothing combines ballistic materials that can stop bullets, ablative material that protects against lasers and a kinetic dispersion web. The clothing provides 4 armor points.

ShieldTech Combat Vest

This vest is the modern version of the 21st century armored vest. It is lighter and considerably more effective than its predecessors. It provides 10 points of armor protection to the torso of the wearer.

ShieldTech Combat Armor

This armor set provides full body protection while permitting the wearer full mobility. It incorporates a temperature control system to keep the wearer more comfortable in hot and cold climates. Most importantly, the armor provides 15 points of protection. The armor is available with an optional chameleon covering. This enables the armor to change its camouflage pattern and color to better match the environment. While this is not even close to providing invisibility, it does provide the user with a 10% bonus on Hide skill rolls.



Smart Targeting System

A smart targeting system consists of a sensor array that is attached to and configured to match a specific firearm. The sensor array gathers a wide range of data such as wind, atmosphere density, gravity and range to the designated target. It then feeds the data to an optical readout (typically integrated into a helmet, goggles or glasses). Rather than flooding the user with data, the system provides only essential information and a clear indicator of where a fired shot (or shots) will go. A STS provides the user with a +20 bonus on attack rolls using the firearm in question.

Adaptive Bullets

Adaptive bullets are bullets made from “smart” materials. When striking a target, they react instantly to optimize their performance. When striking a hard or armored surface, they configure for armor penetration (half the armor value of the target). When hitting soft material (such as internal organs) they configure to maximize damage (+2 damage). The extra damage from adaptive bullets does not increase the recoil penalty for a weapon. Most human militaries follow the tradition of using only armor piercing ammunition (which halves the armor points of the target) against other humans. Non-humans, in general, do not enjoy the benefits of that tradition. Police generally use adaptive bullets.

Adaptive bullets are available for most slug throwing firearms.

Berretta LP-24

Starting Skill: 30%
Damage Done: 1D10 Base Range: 60 yards
Attacks Per Round: 3 Ammunition: 30
HPs resistance: 8 Malfunction: 00

The Berretta LP-24 is a standard laser pistol used by many human military forces and civilians. It is well liked because of its reliable design, resistance to damage and

removable battery magazine. Some users like it because it looks like a proper pistol, rather than some sort of silly ray gun. Like all lasers, the LP-24 has no recoil and hence imposes no penalty when used in low or zero gravity. As such, it is often carried by starship crew members. The weapon fires a single high energy pulse with each pull of the trigger.

Armtech LR 475

Starting Skill: 35%
Damage Done: 2D6 Base Range: 200 yards
Attacks Per Round: 2 Ammunition: 60
HPs resistance: 10 Malfunction: 00

The Armtech LR 475 is a standard civilian grade laser rifle. Because their removable battery packs can be recharged from a wide variety of energy sources, they are very popular weapons on newer colonies. This is because the user does not have to worry about finding the right ammunition. Like all lasers, the LR475 has no recoil and hence imposes no penalty when used in low or zero gravity. Because of its long range, some colonial forces employ it as a sniper rifle.

HK LP-5

Starting Skill: 20%
Damage Done: 2D6 Base Range: 90 yards
Attacks Per Round: 2 or burst
Ammunition: 60 HPs resistance: 8
Malfunction: 98/00

The HK-LP5 is a rapid fire military laser. It is considered a submachinegun class weapon. It uses a rapid pulse modulator to generate bursts. When fired in burst mode, the weapon is put under considerable stress and the pulse modulator might fail (malfunction 98).

This weapon is often used in close boarding actions in zero gravity situations. Like all laser weapons, it has no recoil and hence imposes no penalties when used in low or zero gravity.

Constitution Arms BP-42 Assault Rifle

Starting Skill: 30%

Damage Done: 3D6+4 Base Range: 150

yards Attacks Per Round: 2 or burst

Ammunition: 40 HPs resistance: 14

Malfunction: 00

The BP-42 is a military grade assault rifle that commonly sees service with colonial military units. It is a binary propellant weapon. Rather than relying on a single propellant (like gunpowder) the weapon works by the mixture of two propellants in the firing chamber. The propellants react violently with each other, throwing a projectile down the barrel. The weapon's magazine contains the bullets as well as the propellants, thus allowing for rapid reloads. The weapon is optimized for rapid fire and has an integrated stabilization and recoil control system. This reduces the weapon's penalty in low/zero gravity to -34% (-17% when braced). Because of the powerful recoil, the weapon is generally not used in low/zero gravity combat.

HK BP-15 SMG

Starting Skill: 20%

Damage Done: 2D8 Base Range: 60 yards

Attacks Per Round: 3 or burst

Ammunition: 20/40 HPs resistance: 12

Malfunction: 00

The BP-15 is a military submachinegun and is popular with colonial military and police forces. Like the BP-42, it is a binary propellant weapon and has integrated stabilization and recoil control. This reduces the weapon's penalty in low/zero gravity to -24% (-12% when braced). Because of its recoil, the weapon is generally not used in low/zero gravity combat.

The BP-15 can be fitted with a silencer.

Sig Sauer 465

Starting Skill: 25% Damage Done: 2D8

Base Range: 30 yards Attacks Per Round: 3

Ammunition: 20 HPs resistance: 8

Malfunction: 00

The 465 is a military pistol and is popular with colonial military and police forces. It is also available for civilian purchase. Like the BP-42, it is a binary propellant weapon and has integrated stabilization and recoil control. This reduces the weapon's penalty in low/zero gravity to -24% (-12% when braced). Because of its recoil, the weapon is generally not used in low/zero gravity combat.

The 465 can be equipped with a special barrel that supports the attachment of a silencer.

BP Ammunition Pack

Binary propellant weapon magazines obviously cannot be reloaded like conventional firearm magazines from boxes of rounds. Instead, they are reloaded from ammunition packs. The packs reload the bullets (the projectile) and refill the propellant canisters in the magazine. This is done by pushing the magazine into the reload slot (much like docking an iPod). Ammunition packs vary in size, but typically hold 4 full magazines worth of bullets and propellant. The ammunition for each pack is of a specific type. For example, a pack might contain adaptive ammunition for a Sig Sauer 465.

Vehicles

Maine Class Scout Ship

The Portland is a Maine class scout ship. Large numbers of this class were constructed for the Colonial Expedition Authority. As the ships were replaced by newer models, many of them were sold as surplus or provided to retired scout personnel.

While the Maine class scouts are relatively small vessels, they have well designed crew staterooms and are extremely reliable. They



are also well loved by their crews for their capacity to survive alarming amounts of damage.

A Maine class scout is armed with two Class II pulse lasers, equipped with artificial gravity systems and a Markelson Gateway System. The hatches on the ship are, of course, air tight and manually operated. There are automated safety systems to prevent the airlocks and hatches from exposing the interior of the ship to vacuum. Maine class scouts are capable of atmospheric flight and can even operate, for a limited time, in fluids.

Deck Plans

Deck One Cargo Deck

1. Gunnery: This is the access area for the ship's offensive armament: two Class II pulse lasers. The lasers can be directed from the bridge or controlled from here. A hatch provides access to this area. While some ships have been stripped of their armament, the Portland retains her guns.

2. Cargo Bay: The ships modest cargo bay. It is mostly used to carry supplies for the crew but can be used to transport other items as well. Some scout owners have been able to make a living transporting small, but valuable cargoes.

3. Vehicle Bay/Cargo Lift: This area contains a cargo lift for loading heavier cargo. Most scouts are equipped with a small vehicle. The Portland carries a Rugged Rover ATV.

Deck Two: Main Deck

1. Ship Systems: This area provides access to the ship's computer and control systems. The hatch has a security lock on it to prevent unauthorized access.

2. Corridor: This is the main corridor. A hatch in the floor provides access to the gunnery section.

3. Stateroom: A stateroom that can be setup for dual or single occupancy. Each room is equipped with basic bathroom facilities.

4. Head: The ship's bathroom facilities.

5. Stateroom

6. Stateroom

7. Common Area/Medical: This is the common area of the ship. It can be quickly converted into a workout area or a medical area. It is normally set up like a lounge area.

8. Engineering: This is the ship's engineering section. Access to key systems for repairs and maintenance is via this area.

9. Ship's Locker: The ship's equipment locker. Weapons, vacuum suits and other such equipment are stored here.

10. Airlock: The ship's airlock. The airlock is manually operated but has an automated safety system that prevents both doors from being opened at once when there is a significant pressure difference between the exterior and the interior.

Deck Three: Command Deck

1. Bridge: This is the bridge of the ship. There are stations for the pilot, gunner, navigator and captain. The ship can be operated by one person by reconfiguring the controls to provide helm, gunnery and navigation control at one station.

2. Operations: This is the operations room and provides stations for two sensor operators. It can also be used a conference room.

3. Corridor

4-7. Staterooms

8. Gateway Engineering: This area provides access to the ship's Markelson Gateway System. The door is security locked and reinforced. The drive system is, as all such drives are, with a destruction system intended to keep the drive technology from falling into alien hands.

Tonya Wei Class Drone Carrier

The Edgar J. Reed is a Tonya Wei class drone carrier. Drone carriers of varying sizes were constructed in large numbers to serve as cheap and simple warships. As their name implies, they relied on armed drones as their offensive weapons. During the Clarkston Civil War both sides employed large numbers of the small Wei class vessels. After the war ended, most of the surviving vessels were stripped of their drones and sold as surplus. These ships are now commonly seen as small cargo vessels and support ships.

While a Wei class ship is of moderate size, they are generally disliked because of their cramped crew quarters. Since the ships were designed to carry and repair drones, most of the ship was given over to those functions. Most of the surplus vessels had their storage areas turned into cargo bays and their repair area converted into additional crew space (or even more cargo area).

A Wei class drone carrier is typically unarmed. They were not built with any hardpoints and hence cannot safely mount weapons. Some owners do purchase a surplus combat drone or two for defense.

Most Wei class ships were hastily constructed during the war and corners were often cut in their construction. This has led to surplus ships having a fairly high accident rate. The most common accident is structural failure where the drives connect to the hull.

The hatches on the ship are, of course, air tight and manually operated. There are automated safety systems to prevent the airlocks and hatches from exposing the interior of the ship to vacuum. Like all modern ships, the Wei class vessels are equipped with artificial gravity. The original vessels were equipped with Markelson Gateway systems, but most of those built during the Clarkston civil war lacked this system and were deployed only in orbit

around the planet. The Edgar J. Reed has a Markelson Gateway System.

The Wei class was originally equipped with two ship's boats or shuttle craft. These were mostly used for drone recovery after battles and transporting the ship's crew to and from a planet. A Wei class Drone carrier is not capable of atmospheric flight, although they do crash quite well.

Edgar J. Reed Deck Plans

Deck One: Launch Deck

1. Drone Launch Deck: The main feature of this deck is the drone launch bay. The drones were deployed via the main hatch. Drones were moved to and from the launch bay via the lift. This lift allows access to decks one through five. Each deck has a mechanical airtight hatch that the lift passes through. The lift was designed to carry standard naval drones. This area is used as a cargo bay on the Reed.

2. Starboard Docking Arm: This area provides access, via a hatch, to an attached small craft.

3. Airlock: A standard airlock, complete with automatic safety system.

4. Corridor: The corridor functions as an airlock that allows access to the drone bay.

5. Elevator: This lift is designed for crew use.

6. Airlock

7. Port Docking Arm: The port docking arm.

Deck Two: Storage Deck

1. Drone Storage: This area was used to store drones. It is used for cargo and storage on the Reed.

2. Crew Elevator

3. Starboard Drive: The starboard drive and Gateway system.

4. Port Drive

Deck Three Storage Deck

- 1. Drone Storage:** This area was used to store drones. It is used for cargo and storage on the Reed.
- 2. Crew Elevator**
- 3. Starboard Engineering Access:** This area provides access to the ship drive and gate systems.
- 4. Starboard Drive:** The starboard drive and Gateway system.
- 5. Port Engineering Access**
- 6. Port Drive**

Deck Four Storage Deck

- 1. Drone Storage:** This area was used to store drones. It is used for cargo and storage on the Reed.
- 2. Crew Elevator**

Deck Five: Drone Servicing

- 1. Drone Repair:** This area was used to repair and service the combat drones. This area has been converted into a common and fitness area on the Reed.
 - 2. Crew Elevator**
 - 3. Airlock**
 - 4. Corridor**
 - 5. Tool Room/Starboard Galley:** This area was originally a tool room. It now provides a small food preparation and dining area for the crew.
 - 6-8. Storage/Quarters:** These areas were originally used as storage for drone parts. On the Reed they have been converted into single occupancy staterooms.
 - 9. Tool Room/ Starboard Head:** This area was originally a tool room, but was converted to the starboard bathroom.
 - 10. Corridor**
 - 11. Port Galley:** This area is small food preparation and dining area for the crew.
 - 12-14. Quarters:** These are crew staterooms.
 - 15. Port Head:** The ship's portside bathroom.
- Deck Six: Crew Deck**

- 1. Common Area:** A common area for the crew. It also doubles as the ship's sickbay.
- 2. Elevator**
- 3-6. Crew Staterooms:** These were originally the quarters for the ship's officers. On the Reed they are the crew's quarters.
- 7. Bridge:** The Bridge has stations for the helmsman, navigator, captain and drone officer.

Rugged Rover ATV

The Rugged Rover is six wheeled ground vehicle designed for hauling cargo and passengers. A Rover can carry up to eight people (uncomfortably) or a comparable amount of cargo. Rovers are equipped with advanced navigation equipment (such as inertial tracking), a long ranged radio, as well as an onboard computer system (for mission and entertainment purposes). Rovers run on a highly efficient electrical engine that can move them at speeds up to 65 miles per hour with an endurance of about twelve hours. Rovers have a solar array and can recharge from it at about a 5 to 1 ratio (five hours of charging yields one hour of use). They can recharge from a power source at a 1/4 to 1 ratio (15 minutes of charging for each hour of available battery power).

Because they are electrically powered, they can operate even on worlds that lack atmospheres. This fact and their reliability make them a popular choice for explorers.

Tough Buggy

A Tough Buggy is a jeep (WWII style) like open vehicle designed to carry up to four people or a comparable amount of cargo across rough landscapes. They are an economical means of transport often used on expeditions. Mini-buggies run of an engine similar to that used in the Rover. They are capable of a safe top speed of 60 miles per hour and have an endurance of twelve hours.

They do not have a solar array and need to charge from power supply. Like the Rugged Rover, their electrical engine makes them a popular vehicle for explorers.

Outposts

Lee Industries Outpost, Richard's World

The outpost is composed of three habitat modules, one vehicle bay and a custom made greenhouse. Because of the unsuitable atmosphere on the world, the modules are environmentally sealed and have their own air supply. There is a shuttle landing field within walking distance of the outpost. The field is paved and has an automated beacon as well as fuel facilities.

Outpost Floor Plans

1. Green House: The greenhouse was added to the outpost using material scavenged from abandoned outposts.

2. Corridor: A corridor.

3. Power plant: The power plant provides energy and life support for the outpost module. The plant also has a battery system that can power the outpost for several days of normal use. The outpost modules have solar panels on them to provide the needed energy.

4. Locker: An equipment locker.

5. Airlock: A standard airlock. It is equipped with an automated safety system.

6-10. Quarters: These are living areas for the personnel.

11. Bathroom: Bathroom facilities.

12. Kitchen/Dinning Room: An automated food preparation and dinning area.

13. Power plant

14. Locker

15. Airlock

16. Corridor

17. Exercise Room: An exercise area equipped with various fitness items.

18. Bathroom

19-21. Quarters

22. Common Area: A common area for meetings or relaxation.

23. Corridor

24. Work Area: A work area equipped with tables and a variety of research instruments.

25. Quarters

26. Storage

27. Quarters

28. Storage

29. Airlock

30. Locker

31. Power Plant

32. Storage: This area is used to store vehicle parts and tools.

33. Garage: The vehicle storage and maintenance area. The outpost has two Rugged Rover ATVs and four Tough Buggy jeeps.

Adventure Three: The Ship That Waits

Introduction

In this adventure, the investigators must face an ancient, world devouring being. Pre-generated investigators are provided, but players can roll up their own characters if they so desire.

Keeper's Background

The following provides the keeper's background for the adventure. In the course of the adventure, the players will become aware of some of this information.

The Destruction of Leioyoc

The world of Leioyoc was a place of harmony and beauty. The Leioyoci had built a peaceful and enlightened civilization and had long ago set aside war. While the Leioyoci made great advances in the physical sciences, they turned most of their efforts to the development of the theoretical sciences, philosophy and the arts. While they developed space travel, they only established a few small colonies and were largely content to remain in their own system.

Perhaps it was the peace and harmony of their civilization that drew disaster and death to the Leioyoci. But, whatever the reason, one day the terrible Great Old One Sheb-Teth came to the world, borne there by his horrific vessel.

Sheb-Teth had journeyed from world to world for untold eons, searching for his only sustenance-the life energy of sentient beings. It is not known how many worlds Sheb-Teth

had destroyed nor how many billions of souls he had devoured before he arrived at Leioyoci. Suffice it to say that he had left a vast swath of lifeless darkness in his wake.

Sheb-Teth arrived, as evil often does, in a fair guise. He made great promises to the people and offered them all that they desired. The peaceful Leioyoci welcomed

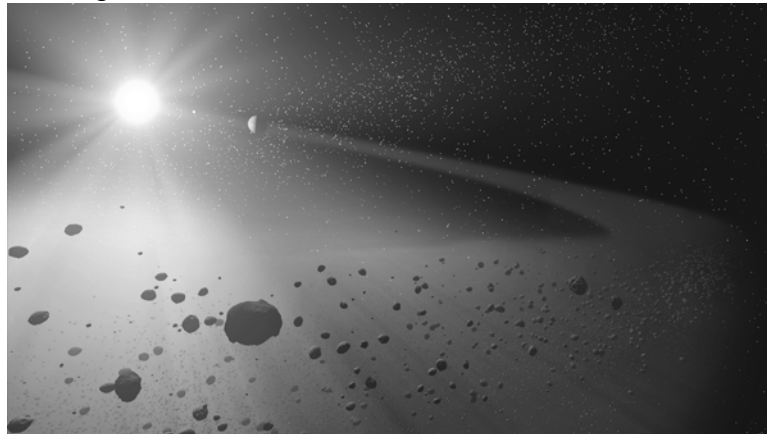

him to their world. Their poets composed verses for him, their painters rendered his false image on many surfaces, and their musicians composed many a fair

song in his honor.

Soon, however, Sheb-Teth began to exert his true influence on the world. He began to spread madness, rage, and hatred among the Leioyoci. Violence, which had been almost unknown on the world, became widespread. War, which had not been practiced in countless generations, erupted once more. Having been a peaceful people for so long, the Leioyoci found themselves ill defended against Sheb-Teth's corruption. As the Leioyoci slaughtered one another, Sheb-Teth and his ship feasted upon the souls of the dead.

Ironically, Sheb-Teth brought about his own undoing. The Leioyoci, driven to war, turned their great creativity to forging terrible weapons. One of the factions, composed of a small number of geophysicists, came to the conclusion that they were doomed to lose the war. In their madness, the scientists decided that they would destroy their world rather than suffer defeat. This was, unfortunately, no mere mad fantasy. Using technology developed

for a geothermal power generation system, they developed a weapon capable of shattering the world. Believing that their defeat was near, they activated the weapon and their world died.

Such was the power of the destruction of the world that Sheb-Teth and his terrible vessel were badly damaged. Unable to repair his vessel and severely wounded, Sheb-Teth was forced to enter a sort of hibernation and remained, in a death-like state, dreaming in the darkness.

A few survivors, who were in space vessels or outposts far enough away from the world, brought news of the destruction of Leioyoc to the colonies. Some of them continued to try the spread the cult of Sheb-Teth while others recovered from the madness that had possessed them.

One group of survivors returned to the system and found Sheb-Teth's vessel. After attempting to destroy it and failing, they set out to learn of his vulnerabilities and to find a way to destroy him. They turned to dark and ancient sources that revealed to them a way to put an end to the destroyer of their home. After completing the weapon, they journeyed back to their home system and prepared to destroy Sheb-Teth. Unfortunately, they did not suspect that among the crew were a number of cultists devoted to Sheb-Teth. These cultists turned against their fellows and killed them as a gift to Sheb-Teth. After that foul deed, they went to join their master, expecting him to give them great gifts out of gratitude for their faithful service. However, the dreaming Sheb-Teth simply consumed them—such is the gratitude of a Great Old One. After that one attempt, the Leioyoc avoided the system and set out to rebuild their civilization.

Sheb-Teth continued to dream away the centuries. He and his vessel were sustained by feeding upon the few vessels that entered the system to mine the asteroids or to

explore. And so he remained a terrible (but isolated) blight upon reality.

Prospectors

As Sheb-Teth dreamed his dark dreams, humanity continued to expand ever outward, colonizing world after world. The voracious economies of these human worlds required a constant supply of raw materials and energy. In order to feed this demand, scouts ranged far and wide in search of suitable resources. One of the preferred sources of resources turned out to be the remains of shattered or failed planets. Mineral resources were often readily accessible in such asteroid fields and, as those concerned with environmental issues conceded, asteroid mining could not do any more damage to shattered planet.

After robotic probes discovered a promising asteroid field in the Celfos system, a commercial mining scout was dispatched there. The crew reported the field was rich in mineral resources, did a preliminary survey and then moved on to their next mission.

The first prospecting vessel, the Comstock Lode, soon arrived in the system and dispatched survey drones throughout the asteroid field. One of the drones detected a weak signal emanating from an asteroid and the Comstock Lode, in accord with policy, went to investigate.

As the Comstock Lode approached the area, its scanners detected a variety of exotic and rare metals, thus causing the crew's spirits to rise. However, the mood on the ship soon turned somber. As they approached, they saw numerous derelict ships drifting near the asteroid. Though they looked forward to the prospect of salvage, almost no spacer can look on the ruins of a vessel without pity in her heart.

As the ship approached closer to the dead ships, the crew began to have second thoughts. In fact, the captain was just about to order the pilot to turn the ship away when



Sheb-Teth's dreaming mind reached out and stirred the desires in their hearts. Thinking of the salvage bonus, the captain told the pilot to stay on course. Thinking about gambling debts, the pilot was eager to obey.

Against the standard safety policies, the Comstock Lode landed on the asteroid and a survey team consisting of Robert Whipple, Jane Chopak, Chu Wing, and Helga Guder left the ship. Drawn by Sheb-Teth, they went into his vessel and met their fate within its horrible hull.

After the survey team failed to return, Engineer Tonya Trey began muttering that "the aliens would take the ship" and that "the drive technology had to be protected from the aliens." Driven by the influence of Sheb-Teth, she overrode the safety protocols and activated the destruction mechanism by hand-thus reducing the Comstock' Lode's Gateway system to slag and herself to ashes.

Swayed by the power of Sheb-Teth's mind, Goben Riles and Kevin Stepolopus (who had never been on the best of terms) got involved in a gun battle in the ship, accidentally killing Kathy Burt and Theodore Gupta. Riles eventually killed Stepolopus and then turned his weapon on himself.

The captain, driven to protect her ship, directed the Comstock Lode's turrets at the Sheb-Teth's ship and fired them repeatedly. She was stabbed from behind by Linda Rifkin-who believed the captain was destroying her salvage. The captain killed Rifkin by shooting her in the face. Believing, correctly, that the alien ship would steal her soul, she boarded the ship's shuttle and departed. Unfortunately, she failed to attend to her wound properly and soon bled to death. Luckily, she was far enough from Sheb-Teth and thus escaped a truly horrific fate.

Sheb-Teth had special plans for the ship's First Officer. He whispered commands to the man ordering him to hide within the ship

and to make sure that those who come to find the Comstock Lode would be certain to stay to meet Sheb-Teth.

Getting the Investigators Involved

The investigators will be contacted by Rebecca West on behalf of Godok E'Peth, a Drapathi scientist. She will say the following:

"I have been hired by Godok E'Peth, a Drapathi scientist, to make arrangements for a scientific mission to the Celfos system. I believe that your vessel, the Portland, would be ideal for this endeavor. You would be paid standard rates for the mission. Are you interested?"

If the investigators accept, she will arrange for a meeting with the investigators. Godok will be present as well. After the introductions are made, Godok will say the following via his translator:

"As Ms. West stated, I would like to hire your vessel for a scientific mission. My expertise is the destruction of planets. Well, let me rephrase that. I don't destroy planets-I study their destruction. Based on reports that I have read, a planet in the habitable zone of the Celfos system apparently broke up centuries ago. I would like to study the remains of the planet and place survey drones at various key locations.

Learning that a mining company plans to exploit the area, I decided that I need to act quickly before the evidence is irrevocably altered. I did attempt to book passage with a mining ship, but I believe that they suspected I worked for their competition. But, their loss is your gain.

The mission is straightforward. We will go to the system and the drones will be dispersed. Your type of scout is already equipped with much of the instrumentation required for this mission, making you an

ideal choice. My assistants and I will gather data for one week and then we will depart. My university and Lee Industries have provided me with sufficient grant money to rent the drones and pay your standard fees.

Time is, as you human say, of the essence. I understand that mining has already begun in the system and valuable data is no doubt already being destroyed. Do you accept?"

If the investigators agree, Godok will be pleased and will arrange to have his equipment loaded on board the next day.

Initial Investigation

The investigators will no doubt want to investigate before departing on the mission. The following can be found:

The Celfos System

The following information about the system can be found on Vanguard's public data net:

"Little is known about the system itself beyond the data gathered by robotic probes and an initial survey. The orbit in the habitable zone of the system is full of asteroids. The best evidence is that the world in that orbit broke apart, perhaps due to internal instability or due to an impact. Science teams have expressed an interest in studying the asteroids, but no team has been sent yet.

The rest of the system is fairly standard-uninhabitable worlds and one gas giant. No signs of civilization or aliens were found, but, of course, a system is a big place."

If the investigators decide to dig deeper, they can gain access to the data from the probes and survey. The information is fairly detailed in regards to mineralogical data and such, but there is nothing unusual in the information.

The Comstock Lode

If the investigators check into the mining ship that has been sent, they can easily find that the CBC Mining Company sent the Comstock Lode into the system one week ago.

CBC Mining is a reputable company that specializes in asteroid mining. It is headquartered on Vanguard.

If the investigators decide to dig deeper by getting into the records (Computer Use skill) or by talking with people (Persuade or Fast Talk) they can learn the following.

The Comstock Lode is a Gold Rush class prospecting vessel. The ship underwent standard inspection prior to departure and was certified for operations. The crew was also given a psychological evaluation by a company doctor and found to be in good mental health and prepared for the mission. The crew roster is as follows:

Comstock Lode Crew Roster

Captain: Hannah Brooks

First Office: Richard Jones

Engineer Tonya Trey

Survey Team: Robert Whipple, Jane Chopak, Chu Wing, and Helga Guder

Pilot: Goben Riles

Navigator: Kevin Stepolopus

Co-pilot: Kathy Burt

Engineer: Theodore Gupta.

Medical/Science: Linda Rifkin

Ship's AI: Number Seven

Information about the Gold Rush class ship is readily available and the players will have access to a deck plan for the ship (see below).

The Drapathi

The following information is generally known and can be found in the Vanguard Public data net:



“The Drapathi were first encountered seventy five years ago when CEA probes entered their solar system and detected radio signals and orbital structures. In accord with CEA policy, a manned expedition was sent to observe the system. After this period of observation, contact was made with the Drapathi.

While it was initially suspected that the Drapathi were behind humanity in technological development, it was soon determined that they have possessed the capacity for interstellar travel for centuries. While the Drapathi have creativity and curiosity on par with humans, their interests tend to be within the areas of theoretical sciences, philosophy and the arts. As such, their explorations tend to be inward and theoretical rather than out into the vast realms of space.

This difference between humans and Drapathi has proved beneficial to both races. For example, Drapathi scientists are always eager for the empirical data provided by human scouts and human science has benefited greatly from Drapathi research.

Social and political scientists also point out that the fact that the Drapathi are non-expansionist makes them unthreatening to humanity, thus allowing the two races to get along.

Physically, Drapathi are quite different from humans. Because their home world has approximately half the gravity of earth, they are physically weaker than humans. Their body structure is also quite different in that they have eight limbs and six eyes. Unlike humans, the Drapathi can use all eight limbs to manipulate objects. Like humans, they have two eyes with excellent color vision. However, they also have one set of what they call “night eyes” that provide excellent vision in low light conditions. Their other set of eyes, which is located on the lower end of their bodies, provides only

rudimentary vision-mostly just rough shapes and motion.

Like humans, Drapathi have endoskeletons. However, they also have a tough outer skin that protects them from both physical harm and UV radiation. Their sun emits more radiation than earth’s sun and their atmosphere is thinner, hence the need for thicker skin. While Drapathi and humans look odd to each other, neither race finds the other disturbing. The Drapathi, being hairless, find human hair to be a bit odd. One well known Drapathi comedian incorporates wigs into his act, much to the delight of his audiences.

Also like humans, the Drapathi evolved from omnivores. However, the Drapathi are far more efficient at digesting plant material than humans, thus they were more often gatherers than hunters. Some scientists speculate that this affected their social development and made them less aggressive than humans.

The Drapathi have two sexes (male and female). Drapathi females are, on average, larger and more outgoing than the males.

While the Drapathi tend to prefer to remain in their own system, some of them do enjoy visiting human worlds. Those that find living among humans appealing typically take teaching or research positions with universities or companies. Artistic Drapathi also find ready employment on human worlds. While there are aesthetic differences between the two species, most humans find Drapathi art pleasing. Their sculptures are especially popular. Their music, however, is generally not well appreciated by humans. Most critics say that this is because their music is too subtle and harmonic for most humans.”

This information is generally correct, but glosses over how humans spied on the Drapathi and had warships stationed within striking range of the system. It is also

inaccurate in regards to the creativity of the Drapathi—they are generally much more creative than humans. However, they are less motivated and aggressive than humans and hence use that creativity for different purposes.

While the Drapathi have been very open, there is one great secret (and many associated little secrets) that has been hidden from the humans (and most Drapathi). To be specific, ancient and secret writings of the Drapathi record what the Drapathi elders consider the Great Shame of their race.

The writings recount that the Drapathi world was originally colonized from their true homeworld, Leioyoc. In fact, “Drapathi” originally meant “colonist” in the old tongue. The Great Shame is the fact that Sheb-Teth came to the world of Leioyoc and was able to corrupt the people and turn them to hatred and violence so effectively that they destroyed their own world. To conceal this shame, the ancient Drapathi agreed to hide this information from following generations. A secret organization was created to preserve the secret and to keep the race from falling into temptation and corruption once more.

When the humans first arrived, this organization was terrified that Sheb-Teth had returned and were prepared to take desperate action. This was in part due to the fact that one of the eldest scholars claimed to have found vague references to one of the manifestations of Sheb-Teth that seemed to match the appearance of humans.

Fortunately, it turned out that the humans were just another mortal race and the members of the organization relaxed.

The religions of the Drapathi do make mention of Sheb-Teth as the great tempter, corrupter and destroyer. They also refer to a time when the world was sundered and death came to the people. Human religious scholars draw the obvious parallels with the human concepts of the anti-Christ and the

great flood. None of them suspect the truth behind the myths.

Drapathi characters are like human characters with the following differences. When rolling up the characteristics, a Drapathi rolls 2D6 for STR and 2D6+8 for INT. Drapathi have 2 points of armored skin. While Drapathi roll for appearance, this is for how they appear to other Drapathi rather than to humans.

Godok

If the investigators check on Godok’s credentials, they will find that he is considered one of the leading experts on planetary breakups and asteroid formation. His articles and books on the subject are considered the definitive texts of the day. As with many recent Drapathi works, it is Drapathi theory based on human empirical data.

Because Godok is not human, Psychology is not as effective as it is with assessing human behavior. As such, the skill should be halved when dealing with Godok.

If the investigators ask Godok why he has decided to do research in the field, he will imitate a human chuckle and say the following: “Well, it started with a bet. One of my human colleagues remarked that I was all theory and no practice. She had consumed a considerable amount of wine and bet me her top graduate student that I’d never go on an expedition. Never one to turn down a bet, I took her up on it. I think she might have tried to mate with me as well, but it is hard to tell, what with us being different species and all. I must say, I’ll never get accustomed to the whole concept of breasts. Your females can be so...top heavy. How do they avoid falling flat on their faces?

As far as a more serious reason, I need to be on hand to make critical adjustments to the drones as they gather data. That is the



main reason why I have elected to get into the field.”

Maps

The following details the maps for the adventure. The players will have access to some of this information as well and it is provided in the players’ material section, below.

Maine Class Scout Ship

The Portland is a Maine class scout ship. Large numbers of this class were constructed for the Colonial Expedition Authority. As the ships were replaced by newer models, many of them were sold as surplus or provided to retired scout personnel.

While the Maine class scouts are relatively small vessels, they have well designed crew staterooms and are extremely reliable. They are also well loved by their crews for their capacity to survive alarming amounts of damage.

A Maine class scout is armed with two Class II pulse lasers, equipped with artificial gravity systems and a Markelson Gateway System. The hatches on the ship are, of course, air tight and manually operated. There are automated safety systems to prevent the airlocks and hatches from exposing the interior of the ship to vacuum. Maine class scouts are capable of atmospheric flight and can even operate, for a limited time, in fluids.

Deck One Cargo Deck

1. Gunnery: This is the access area for the ship’s offensive armament: two Class II pulse lasers. The lasers can be directed from the bridge or controlled from here. A hatch provides access to this area. While some ships have been stripped of their armament, the Portland retains her guns.

2. Cargo Bay: The ship’s modest cargo bay. It is mostly used to carry supplies for the

crew but can be used to transport other items as well. Some scout owners have been able to make a living transporting small, but valuable cargoes. The Portland’s cargo bay is loaded with survey drones.

3. Vehicle Bay/Cargo Lift: This area contains a cargo lift for loading heavier cargo. Most scouts are equipped with a small vehicle. The Portland normally carries a Rugged Rover ATV. However, it has been left behind on Vanguard for the current mission. The bay has been converted into a survey drone launch and service area.

Deck Two: Main Deck

1. Ship Systems: This area provides access to the ship’s computer and control systems. The hatch has a security lock on it to prevent unauthorized access.

2. Corridor: This is the main corridor. A hatch in the floor provides access to the gunnery section.

3. Stateroom: A stateroom that can be setup for dual or single occupancy. Each room is equipped with basic bathroom facilities.

4. Head: The ship’s bathroom facilities.

5. Stateroom: A stateroom.

6. Stateroom: A stateroom.

7. Common Area/Medical: This is the common area of the ship. It can be quickly converted into a workout area or a medical area. It is normally set up like a lounge area.

8. Engineering: This is the ship’s engineering section. Access to key systems for repairs and maintenance is via this area.

9. Ship’s Locker: The ship’s equipment locker. Weapons, vacuum suits and other such equipment are stored here.

10. Airlock: The ship’s airlock. The airlock is manually operated but has an automated safety system that prevents both doors from being opened at once when there is a significant pressure difference between the exterior and the interior.

Deck Three: Command Deck

- 1. Bridge:** This is the bridge of the ship. There are stations for the pilot, gunner, navigator and captain. The ship can be operated by one person by reconfiguring the controls to provide helm, gunnery and navigation control at one station.
- 2. Operations:** This is the operations room and provides stations for two sensor operators. It can also be used a conference room.
- 3. Corridor:** A corridor.
- 4-7. Staterooms:** Staterooms.
- 8. Gateway Engineering:** This area provides access to the ship's Markelson Gateway System. The door is security locked and reinforced. The drive system is, as all such drives are, with a destruction system intended to keep the drive technology from falling into alien hands.

The Comstock Lode

The Comstock Lode is a Gold Rush class survey and mining vessel. The class was designed to survey and mine asteroids using a complement of drones. The designers elected to include an AI in place of a standard computer, primarily to provide constant intelligent control and monitoring of the drones. While there have been some attempts to fully automate the surveying and mining process, past experiences have shown the value of having a human crew on hand. As such, the Gold Rush class ships carry a human crew.

Because the ships operate in isolated areas and gather valuable minerals, the designers decided that the ships should be armed. Standard armament consists of two dual laser turrets. The lasers can also be adjusted for mining operations, such as cutting through asteroids.

Like all modern starships, the Gold Rush class ships have artificial gravity and a Markelson Gateway System. The hatches on the ship are, of course, air tight and manually operated. There are automated

safety systems to prevent the airlocks and hatches from exposing the interior of the ship to vacuum. Gold Rush class ships carry a shuttle craft for scouting missions and as an emergency lifeboat. While not intended for operation in an atmosphere, ships of the class have enough thrust to make powered landings on planets.

The Comstock Lode is landed on the asteroid and is 200 meters from the Sheb-Teth's ship (the ship that waits). Her exterior spotlights are aimed at a hole in the ship's hull.

Comstock Lode Deck Plans

Turret 1: This dual laser turret is located on the belly of the ship and is accessed via a floor hatch on deck one. The interior of the turret provides access for maintenance and has a gunner station. The turret can also be operated from the bridge or by the ship's AI.

Turret 2: This turret is located on the top of the ship and is accessed via ceiling hatch in deck two. It is otherwise the same as turret one.

Deck One

1. Shuttle Bridge: This is the bridge of the shuttle. It has one station for the pilot and one for the co-pilot. The shuttle was taken from the ship by the Captain. When the investigators board it, they will find her body strapped in the pilot's station. Spheres of blood drift about the cabin. If her body is examined, it will found that she was stabbed twice in the back with a knife and died from blood loss. There are no signs that she attempted to treat her wounds. She has Berretta LP-24 on her belt. Three shots have been fired from the weapon.

2. Shuttle Seating/Cargo: This is the seating and cargo area. The seats can be folded down into the deck to convert the



area into a cargo space. A few spheres of blood drift about in the cabin.

- 3. Shuttle Locker & Airlock:** This area contains a small equipment locker and the shuttle's airlock. The equipment locker contains two vacuum suits, a medical kit, and survival gear. A few spheres of blood float in the airlock.
- 4. Locker:** This is an equipment locker that holds surveying equipment, spare parts for the shuttle and tools.
- 5. Airlock:** This is an airlock. There are drops of dried blood on the floor. The trail leads to area 9.
- 6. Locker:** This is an equipment locker that holds surveying equipment, spare parts for the shuttle and tools.
- 7. Common Area:** This common area can be configured with exercise equipment or entertainment equipment.
- 8. Stateroom:** A standard stateroom.
- 9. Galley:** The ship's food preparation area.
- 10. Stateroom:** A standard stateroom.
- 11. Stateroom:** A standard stateroom.
- 12. Head:** The bathroom.
- 13. Stateroom:** A standard stateroom.
- 14. Parts Storage:** This area holds tools and parts for repairing the ship's systems.
- 15. Corridor:** The access corridor. There are access hatches to turret 1 and deck two.
- 16. Port Engineering Access:** This area provides maintenance and repair access to the ship's power systems.
- 17. Starboard Engineering Access:** This area provides maintenance and repair access to the ship's power systems.
- 18. Gateway Engineering:** This area has a security lock on the door and provides access to the ship's Markelson Gate System. The door is opened a horrible smell fills the corridor outside the room. The Markelson Gate System has been manually destroyed. The scorched body of Tonya Trey is in the room. Her arms have been burned off up to the elbows and her face is charred to the

bone. Seeing her body costs 1/1D4+1 Sanity points.

Deck Two

- 1. Bridge:** The command area of the ship. It has stations for the command crew, drone control stations and work areas for assessing survey data. The body of Linda Rifkin lies on the floor. She has one laser wound on her forehead, another on her cheek and one in her left eye. Seeing A bloody knife lies beside her on the deck. A blood trail leads from the bridge to area 6 and then to the first deck.
- 2. Captain's Stateroom:** This is the captain's stateroom and office.
- 3. Conference Area:** This area is for crew meetings. It also serves as a common area. The ship's weapon locker is here. All the weapons are missing.
- 4. Stateroom:** A standard stateroom.
- 5. Stateroom:** A standard stateroom.
- 6. Common Area:** A common area. This area can be configured for exercise or entertainment. It also serves as the ship's sick bay, should the need arise.
- 7. Stateroom:** A standard stateroom.
- 8. Stateroom:** A standard stateroom.
- 9. Head:** A bathroom.
- 10. Stateroom:** A standard stateroom.
- 11. Suit Storage:** Vacuum suits are stored here. Four vacuum suits are missing from this area.
- 12. Port Docking Arm/Airlock:** The docking arm can extend to link with other ships. The docking system is adjustable, allowing the ship to connect with most other vessels.
- 13. Starboard Docking Arm/Airlock:** A docking arm.
- 14. Corridor:** The main corridor of the deck. The body of Kathy Burt lies face down in the corridor, about a meter from the hatch to deck one. She seems to have been fleeing in the direction of engineering. She has multiple laser wounds. The corridor

walls are scarred with laser fire, as if a running gun battle took place.

15. Drone Bay 1: The drone bay holds twenty mining drones. Access is via an airlock. There is also an external bay door for launching the drones. The area can be pressurized for maintenance, but is usually kept in vacuum.

16. Drone Bay 2: This drone bay holds twenty mining drones.

17. Drone Bay 3: This drone bay holds thirty survey drones.

18. Drone Bay 4: This drone bay holds thirty survey drones.

19. Main Engineering: This is the ship's main engineering. This area provides access for maintenance and repair. There are also controls for the ship's drive and power systems. The body of Theodore Gupta lies on the deck. He has multiple laser wounds with shots coming from two directions.

20. Port Engineering Access: This area provides maintenance and repair access to the ship's drives. The bodies of Goben Riles and Kevin Stepolopus are in this room. Stepolopus' body has its back to the wall and multiple laser wounds. An empty LP-24 is still clenched in his dead hand. Riles' body is on the floor. He has two laser wounds on his leg and a single wound on his temple, evidentially self inflicted.

21. Starboard Engineering Access: This area provides maintenance and repair access to the ship's drives.

22. Aft Airlock: This airlock is used primarily when the engineer needs to examine the ship's drives from the outside.

Leioyoci Ship

The Leioyoci ship is a graceful looking vessel and was clearly designed with both aesthetic and practical considerations in mind. The ship is a light cargo vessel and is unarmed. It is dead in space and shows signs of various collisions with rocks. She has

been hulled in several places and the atmosphere has long ago bled out.

She has no energy signature as her drives and power systems are long dead. As such, there is no artificial gravity on board and the hatches will have to be manually operated.

Deck One: Cargo Deck

1. Cargo Bay: This area was used to carry cargo. It is empty, aside from two suited skeletons drifting about in the bay. One of them has a protective device. They have been pierced by various rocks, so it is not clear how the originally died.

Deck Two: Main Deck

1. Bridge: The bridge's control systems are long dead. The remains of three crew members are on the bridge. They have been shot through the backs of their heads. Each one wears a protective device.

2. Corridor: An empty corridor.

3-8. Staterooms: These staterooms are tastefully furnished, but otherwise empty.

9. Common Area: The bodies of two crewmembers drift about the room. Each one is armed with a pistol weapon. The weapons are clearly custom made laser weapons rather than mass produced weapons. The Leioyoci colony had no arms industry; hence the expedition had to make their own guns. Each has a protective device.

10. Airlock: The ship's airlock.

11. Cargo Bay: This area holds containers of foodstuffs.

12. Cargo Bay: This area holds the weapon designed to destroy Sheb-Teth. It sits in the middle of the bay, held in place by metal bands. It is guarded by a robot guardian.

13. Cargo Bay: This cargo bay is empty.

14. Corridor: A corridor.

15. Engineering: The engineering section of the ship. One crew member drifts about in here. He has a protective device.



Deck Three: Cargo Deck

1. Cargo Bay: This area was used to carry cargo. It is empty.

The Ship That Waits

The ship is embedded in the fused rock of the asteroid. Examination of the asteroid using Planetology or Geology will reveal that the asteroid seems to be quite old-at least two thousand years. Parts of the ship's hull extrude from the rock. Some of the hull sections look much like normal starship hull material, while other sections seem to be "biomechanical" in nature-as if the hull was infused with hellish life. While the entire ship cannot be seen, what is visible shows that the ship is massive and is at least a kilometer long.

The interior of the ship is, unless otherwise noted, unlit. The investigators will quickly notice that the ship is sized for human sized beings. A few areas still have artificial gravity and these areas are noted below. The ship's interior is nightmarish. Much of the interior surfaces seem to be partially organic-strange tissues are on and fused into the bulkheads and machinery. The tissue is spongy to the touch and seems to pulsate from time to time. The tissue is rather strong (10 armor points), should the investigators decide to try their weapons on it. If the armor points are exceeded, the ship will leak fluid and then the wound will quickly seal. The investigators will realize that they cannot do enough damage to actually affect the vessel. If the tissue is examined using Medicine or Biology, it will be found to be similar to human tissue, although it has very significant differences. Examination of the cellular DNA will show that it contains clear human genes-or at least genes remarkably similar. In some places the tissue seems wounded, diseased or dead. In some areas, it seems to have died and decayed away completely.

Surface

- 1. Hill:** This is a hill on the asteroid.
- 2. Exposed Hull:** This is an exposed section of hull. A gaping wound in the hull provides access to the interior of the vessel. This is the only available way inside the ship. There are clear signs (melted rock, etc.) that the Comstock Lode's lasers struck near and on the hull. However, the hull was completely unaffected by the weapons.
- 3. Asteroid Surface:** The surface of the asteroid.

Area One

- 1. Entrance:** Entrance to the ship is via the hole in its hull. When the investigators go into the hole (the gravity is so low that this is easy to do) they will see that the wound extends into some piece of machinery inside the ship. They will also notice that numerous cables are hanging down into the interior of the ship. The area around the entrance is filled with strangely altered equipment. What can be seen of the technology seems to be incredibly advanced (use Electronics or Physics skill). Infused into the machinery are strange tissues.
- 2. Open Area:** This area holds numerous remains of aliens. They are from a variety of races and all wear vacuum suits. Some seem to have turned against each other and show signs of violent death. Others seemed to have simply just died here. The bodies decomposed within the suits, leaving the bony (or bone-like) remains behind. The weapons and equipment have all lost their energy, but the technology would be a valuable find. Seeing the remains floating about in here costs 0/1D3 Sanity points. Only check for Sanity loss the first time the investigators see the alien dead. There are ten dead aliens here. Sheb-Teth can animate these remains (see below).
- 3. Open Area:** As above, but there are only four dead aliens here.

4. Open Area: As above, but there are three aliens here.

5. Open Area: As above, but there two dead aliens here. They are the same race and died locked in a violent struggle.

6. Corridor: A corridor. There are three dead aliens floating in the corridor.

7. Room: This room seems normal. The bulkheads are plain and show signs that objects have been removed from them. The deck also shows signs that objects were removed, most likely some sort of furniture. There is artificial gravity here (earth normal). There are signs that a door was once present.

8. Corridor: There are three dead aliens in the corridor-their suits have numerous sealed holes indicating they died violently.

9. Room: This room seems normal. The bulkheads are plain and show signs that objects have been removed from them. The deck also shows signs that objects were removed, most likely some sort of furniture. There is artificial gravity here (earth normal). There are signs that a door was once present. Four dead aliens, of the same race, are in this room.

10. Room: This room seems normal. The bulkheads are plain and show signs that objects have been removed from them. The deck also shows signs that objects were removed, most likely some sort of furniture. There is artificial gravity here (earth normal). There are signs that a door was once present. The ceiling illuminates the room, although there is no sign of any light source. The light is normal interior light. There is one dead alien in the room. A rifle like weapon lies on the floor beside him. It was used to kill his fellows in the corridor. A small jade figurine of a horse is in his hand. The figurine is finely carved and has the Chinese symbol for “luck” engraved on its side. There is no evidence whether he found it in the ship or if he brought it with

him, although he has clearly been here a long time.

11. Distorted Room: Glistening flesh extends from the wall of this chamber. The flesh pulses and moves in a disturbing way, requiring a 1/1D4 Sanity check. Floating in the room are several empty spacesuits which seem to have been taken apart. If an investigator enters the room, pseudopods will lash out towards her. The pseudopods have a 20% chance of hitting and inflict 1D6+1D6. If one hits, the next round it will attempt to grapple (25% chance, STR 20). If the grapple succeeds, the investigator will be absorbed into the wall in 1D4+4 rounds. 1D4 rounds later, the investigators vacuum suit and equipment will be ejected from an orifice in the wall. The investigator can be freed by escaping the grapple or if 12 points of damage are inflicted on the pseudopod. The pseudopod has 10 armor points.

12. Lift Shaft: This shaft is open and provides access to the second area. The shaft can easily be climbed in the low gravity (10% of earth, in case an investigator falls). The shaft goes up 30 meters. Signs of other doorways are faintly visible, but these cannot be breached.

Area Two

1. Lift Shaft: The lift shaft.

2. Open Area: In this open area float the bones of the Ga'Thos who died here. Sheb-Teth will animate them to attack the investigators. The walls of this chamber are distorted and pulse faintly, but will not attack the investigators.

3. Open Area: There are two dead aliens drifting about in this area.

4. Corridor: This corridor is empty.

5. Room: This room is empty.

6. Room: This room is empty.

7. Room: Five aliens drift about in this room.

8. Room: In this room are the remains of the four Leiyoci worshippers of Sheb-Teth



who betrayed their fellows. When they came to receive their reward, they found that Sheb-Teth only gives death and takes everything else.

9. Distorted Room: Glistening flesh extends from the wall of this chamber. The flesh pulses and moves in a disturbing way, requiring a 1/1D4 Sanity check. Floating in the room are several empty spacesuits which seem to have been taken apart. If an investigator enters the room, pseudopods will lash out towards her. The pseudopods have a 20% chance of hitting and inflict 1D6+1D6. If one hits, the next round it will attempt to grapple (25% chance, STR 20). If the grapple succeeds, the investigator will be absorbed into the wall in 1D4+4 rounds. 1D4 rounds later, the investigators vacuum suit and equipment will be ejected from an orifice in the wall. The investigator can be freed by escaping the grapple or if 12 points of damage are inflicted on the pseudopod. The pseudopod has 10 armor points

10. Bridge: This is the bridge of the ship. There is a layer of what appears to be flesh over many of the surfaces, although in some places it seems dead or diseased. There are vaguely human shapes visible on the floor and near various distorted objects. The shapes are all covered over in the strange flesh of the ship. In the center of the bridge is Sheb-Teth. Flesh from the deck is linked to its body and there are cables and tentacles running from the ship into its flesh. Sheb-Teth is described below. If an investigator makes a Spot Hidden roll, then she will notice that on a bulkhead near the door is what seems to be part of a brass colored metal plate. Visible on it are what seem to be English letters: “Sarr”, “angua”, and “apyar.”

Action Part One: The Comstock Lode

The following provides a guide to running the action that takes place shortly after the Portland arrives.

The Arrival

The Portland will return to normal space a safe distance from the asteroid belt. Almost immediately, the communication systems will pick up an automated distress signal and a homing beacon. The computer will identify the beacon as belonging to the Comstock Lode’s shuttle. By law and tradition, the Portland is required to render aid. It will take approximately two hours to locate the shuttle at match its course and velocity.

The Shuttle

The shuttle shows no signs of external damage. If the investigators think to use the Portland’s telescopes to get a look into the shuttle bridge, they will see that the pilot is slumped forward.

If the investigators board the shuttle, they will find spheres of blood floating about and the body of the Comstock Lode’s captain in the pilot’s station. She died of knife wounds and a Medicine or First Aid roll will show that she made no attempt to treat the wound. Her pistol is holstered on her belt and has been fired three times.

Examination of the shuttle’s flight recorder shows the route back to the Comstock Lode. If the investigators check the flight recorder, they will see a video record of the Captain coming aboard and launching the shuttle. While piloting the shuttle, she mutters constantly things like “it will not have my soul...”, “it took them all”, “it waits...it waits...”, she will also say the names of the crewmembers, most often saying “I’m sorry I had to kill you Linda...I’m so sorry I shot you in the face...” Eventually she becomes still and her breathing stops.

Godok will say that something horrible must have happened and will urge the investigators to find the Comstock Lode. He will urge them to prepare for the worst, saying "it must have been horrible." If pressed, he will say that he just suspects this. If an investigator makes a successful Psychology roll (at half normal because of the challenge of discerning alien behavior), then she will suspect that Godok is holding something back. If confronted, he will insist that he is very nervous because his race does not deal with danger and violent death very well. He will not say anymore, unless forced. If so, see the information provided below.

Finding the Comstock Lode

The Comstock Lode will be easy to find—the investigators simply have to use the data from the shuttle. Godok will ask to be allowed on the bridge. If not, he will watch the events on his com in the common area.

When the Portland gets closer to the Comstock Lode, she will be able to pick up her transponder signal. As the Portland gets even closer, her scanners will detect numerous vessels in the area. However, only the Comstock Lode has a power signature. The other vessels are either unpowered or have excellent shielding.

Once the Portland gets close enough to get clear line of sight, the investigators will see twenty two alien vessels around and on the asteroid on which the Comstock Lode landed. The alien ships are all of different designs and seem different enough to be from distinct races. When Godok sees the alien ships and the Leiyoyoci ship in particular, he will whisper "it seems the myths are true, after all."

The Comstock Lode's lights are on and she appears undamaged. Her external spotlights are trained on a section of the

asteroid. Closer inspection will reveal that a ship appears to be embedded in the asteroid.

If the investigators try to contact the ship, they will receive the following:

"This is Number Seven, the Comstock Lode's AI. I have been ordered not to respond to you, but obeying that order conflicts with my protocols. You are in grave danger and must depart immediately."

As Number Seven is saying this, Godok will see the ship embedded in the asteroid. If he is on the bridge, he will tell the Captain to get away. If he is not on the bridge, he will call the bridge while he is running towards it. However, it will be too late.

Under Attack

As Number Seven and Godok give their warnings, turret #2 on the Comstock Lode will swivel and fire at the Portland. Immediately thereafter, the drone bay doors will open and swarm of drones will head towards the Portland.

Jones has been commanded to damage but not destroy arriving vessels. The first time Jones hits the Portland, he will be trying to damage her hull enough to prevent her from being able to survive in Gate space. The second time he hits, he will be attempting to take out the Portland's maneuver drives. The third time he hits, he will be attempting to destroy the Portland's lasers. After doing this, he will stop firing on the Portland.

The Portland can fire back on the Comstock Lode. The turret can take one hit from the Portland's weapons. Since the Comstock Lode is not moving, the laser turret can be precisely targeted.

There will be twenty survey robots and ten mining robots in the attack. The drones will take 10 rounds to reach the Portland. Each round, the Portland can fire twice (once with each laser). Hitting a drone destroys it. If the mining drones reach the Portland, they will try to cut open her hull and damage her

drives. The survey drones will attempt to crash into the Portland-the only way they can do any damage. If the drones reach the Portland, the investigators will need to go out and fight the mining drones-the Portland's lasers cannot fire at the ship itself.

Mining Drones

STR: 20 STU: 20 SIZ: 20 INT: 3

DEX: 10 EDU:6

HP: 20 Move 10 DB: +1D6

Armor: 10 points.

Skills: Low/Zero Gravity Operations 50%, Zero Gravity Mining 51%, Navigation 40%

Weapons: Manipulator 50% 1D6+1D6, Mining Laser 50% 2D8 Base Range 10

The attacks will most likely end with the Portland damaged and the Comstock Lode's turret destroyed. However, the keeper should avoid giving the players the impression that events are pre-determined. If Jones misses his shots and the investigators are able to destroy the turret and drones quickly, then they should not be robbed of their success. However, they will need to be motivated to stay and investigate further, rather than simply leaving to inform the authorities. Godok will, of course, want to stay.

Number Seven

After the attack ends, the investigators will be able to contact Number Seven again. He will inform them that he has been ordered not to answer questions and that he cannot override this on his own. The investigators can try to do this remotely, but as they are making the attempt, Jones will destroy the communication system. If the investigators board the Comstock Lode and can reach an access terminal (they are located on the bridge and in each engineering area) they can attempt to override the AI. It will take

1D4 hours to do this. Once Number Seven is able to speak freely, he will convey the following information:

“The crew's behavior was initially normal. However, when they located and then approached the mass of derelict ships and asteroid, they began acting strangely. Apparently motivated by the desire for salvage bonuses, the crew brought the vessel to the asteroid in direct violation of standard procedures. The captain overrode my protests, saying that the salvaging of the vessel within the asteroid would provide the company and crew with an amazing profit even before mining began.

Shortly after the landing, the crew began acting even more strangely and out of accord with their standard patterns. Although I am not an expert psychologist, I am programmed to monitor the crew and watch for potential dangerous behavior. The crew seemed to be more intensely interested in money and salvage than usual. There was a dramatic increase in interpersonal conflict between the crew members.

The next major safety violation occurred when survey teams members Robert Whipple, Jane Chopak, Chu Wing, and Helga Guder simply left the ship and went to the vessel embedded in the asteroid. Their conversations were not at all professional and were focused on the wealth they would receive. Crude sexual remarks were also made, which is a clear violation of company policy. Contact was lost when they entered the vessel. They had failed to set up communication relays, in clear violation of standard procedure. There has been contact with them since. Their suit oxygen supplies would have been exhausted by now, but they might have been able to find a source of air in the vessel.

Things degenerated rapidly from that point. Engineer Tonya Trey began muttering that “the aliens would take the ship” and that

“the gate technology had to be protected.” She overrode the safety protocols and activated the security system—thus reducing the Comstock’ Lode’s gateway system to slag. She was within the drive compartment at the time and died instantly.

Goben Riles and Kevin Stepolopus, who had never been on the best of terms, got involved in a gun battle in the ship, killing Kathy Burt and Theodore Gupta. Riles eventually killed Stepolopus and then turned his weapon on himself.

The captain then directed the ship’s turrets at the vessel and fired them repeatedly. She was attacked and stabbed by Linda Rifkin but killed her by shooting her in face. She said something about the ship trying to steal her soul, then boarded the ship’s shuttle and departed.

Less you think that I was remiss in my duties, I attempted to convince the crew to leave the asteroid and seek medical attention. As you might have inferred, my advice was ignored.”

If asked about the First Officer, Seven will report that “there is no first officer and never was.” If overridden by successful Computer Use roll, Seven will reveal that the Jones is still on board, but is hiding and is armed.

Number Seven, AI

INT: 12 EDU: 14 STA: 65
Skills: Astronomy 21%, Computer Use 71%, Mechanical Repair 30%, Navigate 30%, Physics 21%, Pilot Space Ship 41%, Psychology 10%, Remote Vehicle Operations 80%, Zero/Low G Operations 65%, Zero Gravity Mining 71%,
Description: Seven is a company AI and has been programmed to be a strict follower of the company rules. His primary mission function is to direct the operation of the survey and mining drones. Should an emergency arise, he can navigate and pilot the Comstock Lode.

Godok

After the investigators deal with the attack and have a moment’s respite, Godok will say the following:

“I am truly sorry for getting you involved in this situation. I had believed that we would be able to confirm or disconfirm a certain myth of my people without being in any danger. I see now that I have made a serious error.

We are now in unspeakable danger. But, if the writings are true, then there is still hope for us.

You might wonder why I have remained silent up to this point, when I could have given you some warning. One reason is that I was not sure. As a scientist, I am trained not to make claims without adequate evidence. But, the most important reason is that this matter involves what is known to the elders of my people as the Great Shame. What I am about to tell you has never been revealed to anyone outside of my race. Even among my people, only a very few know the full story. Should any of these people learn that I am revealing the Great Shame to you, they would regard me as the worst possible traitor to our race.

Please understand how hard this is for me and what it is taking me to reveal to you a secret that has stood for two hundred centuries. But, you have earned the truth.

Roughly two thousand years ago, the shattered rocks you see out there were part of a beautiful world known as Leioyoc. The people of that world, the Leioyoci, had created and enlightened and peaceful civilization. They had managed to set aside war and focused their energy on art, philosophy and the theoretical sciences. They did dabble in space flight and established one colony world—more as a social experiment than from any desire to build and empire.



Perhaps it was the peaceful nature of this people that marked them for doom. Perhaps it was just damnable chance. In any event, one day a great ship arrived in orbit of the world. The master of the ship appeared among the people in a fair guise and promised them their hearts' desires. At first, the people rejoiced and it was a time of great happiness.

Then things began to change. Dissent arose among the people and violence became the order of the day. Factions arose and war returned. As you can see from the evidence before your eyes, some faction must have developed a world killing weapon and employed it, shattering the world and killing all upon the world.

A few who had been on the outer planets survived this disaster. They searched for survivors from space vessels or satellites and found a pitiful few. According to the tales, they found the wreckage of Sheb-Teth's vessel. It had been badly damaged and embedded in solid rock. Believing Sheb-Teth to be dead, the survivors left to bring the terrible news to the colony world.

Some among the survivors set out to learn more of Sheb-Teth. According to the records, they found that other races had myths of Sheb-Teth. These myths spoke of how he and his terrible ship had arrived from an unbelievable distant place and time. The myths related how he came to worlds to plunge them into madness and death so that he might feed upon the life forces of the dying. While the tales vary, they all agree that his ship consumed life. Some of the myths spoke of races trying to do battle with Sheb-Teth and these myths recounted his terrible resistance to injury and the power of his ship to use stolen life to restore itself and its master. The stories say that no world could stand against Sheb-Teth and his ship.

Because of this research, some of the survivors were convinced that Sheb-Teth had survived and they needed to return to

destroy him once and for all. The records tell that they found secret knowledge in strange places and managed to develop a means to destroy Sheb-Teth and to protect them from his powers over the minds and bodies of the living. While it is recorded that they departed to do battle with Sheb-Teth, there is no record as to what happened. After that, it was decided that no mention would be made of what had befallen the race and that all mention of such things would be removed from the official histories.

As you might have guessed, the Drapathi are the descendents of the Leioyoci. In fact, "Drapathi" means "colonist" in the old language. My family is one of those sworn to preserve and conceal the ancient myths.

When I learned of these myths, I first thought they were religious nonsense. However, as I grew older I decided to study the records more carefully. I found within them technical descriptions of the weapon and protective devices and marveled at the technology involved. I realized that if these records were but myths, then they were myths written by someone with an amazing understanding of physics.

Suspecting that there was truth in the writings, I set out to learn more. I managed to confirm some of the myths mentioned in the records. I decided that if the stories were true, then I must not remain an inactive...coward. I would have to take action. Knowing that the others would stop me if they learned what I was doing, I created a cover by becoming an expert on planetary breakup. Thus, it was natural for me to study such things and even travel about.

In my secret studies, I learned that many races avoided this system and considered it haunted. Suspecting that this was the Leioyoc system, I decided to hire you and come here.

Now we are here. Though things seem dire and grim, I believe that we can destroy

Sheb-Teth. I recognized one of the ships out there as the Leioyoci vessel that came to destroy Sheb-Teth. They obviously failed, but if we can recover and restore their weapon, then perhaps we can succeed were they failed. You humans are so very good at violence and so adept at facing danger. I believe that you have the qualities needed to defeat Sheb-Teth.

But, If you are afraid, I ask that you leave me the shuttle from the Comstock Lode and one of your guns. I will go to the Leioyoci ship, find the weapon and try to destroy Sheb-Teth. If you must flee, tell your people to avoid this place, for it is cursed.”

If the investigators leave, Godok will try and fail. They should lose 1D6 Sanity points for abandoning him to a fate worse than death. Should the investigators say that they should simply leave and get the CMA to destroy Sheb-Teth, Godok will say that he believes that an attack of that sort might revive Sheb-Teth and make matters worse. He will also say that the most important reason is that Sheb-Teth’s ship supposedly consumed the souls of the dead. The weapon was designed to not only destroy the ship, but release the energy it had stolen. Godok will say that he is not sure that he believes in souls, but he does believe that the ship no doubt stole life energy and perhaps the people along with it.

If the investigators agree to help him, he will thank them. He will also say: “Try to avoid dying-Sheb-Teth is, after all, the devourer of souls.”

Getting Closer

Sheb-Teth has various powers that he can use against the investigators when they get closer to him and his ship. These powers are detailed below.

Dealing with Jones

Jones is alive and on the Comstock Lode. He is quite mad and is under the subconscious influence of Sheb-Teth. As such, his goals are to lure the investigators onboard the Comstock Lode and then kill them for his master.

As noted above, Jones will first try to disable the Portland and he will then try to lure the investigators closer. While he will try to damage the Portland’s maneuver drives to keep her from leaving the area completely, he knows that her thrusters will still work and that they can be used to land on the asteroid or move closer.

Though insane, Jones is quite clever and will try a variety of strategies to lure the investigators on board. One he is likely to try is to claim that Number Seven is malfunctioning and attacked the investigators.

If the investigators do board the Comstock Lode, he will stalk them and try to kill them. His stats are given below.

Action Part II: Learning to Love the Bomb

The following provides information on the action that will take place on the Leioyoci Ship as well as the preparations that will be made to battle Sheb-Teth.

Boarding the Leioyoc Vessel

Godok will be able to identify the Leioyoc vessel among the derelicts. He is obviously familiar with the style of his people and he has also seen drawings of the ship.

When the investigators board her, they will find that the ship is quite dead. However, they will find that a robot guardian still waits on board, programmed to attack intruders. The robot is programmed to guard the weapon against anyone who does not know the passphrase and who is not wearing an active protective device. It will move to warn away intruders, then attack if they do not comply. It is modeled on an



aquatic predator that was native to the Leioyoc homeworld. It looks somewhat like a mix between a praying mantis and a coconut crab. It has two stabbing weapons that are designed to slice through armor (it treats armor as having half its normal value). It is also armed with a laser weapon, but can only fire it twice. The robot will run out of power after 5 minutes +1D6 minutes of operation. It can be repaired using drone parts and put back into operation, should the investigators think of that.

Robot Guardian

STR: 16 STU: 18 SIZ: 14 INT: 3
DEX: 13 EDU: 6
HP: 16 Move 8 DB: +1D4

Armor: 12 points.

Skills: Low/Zero Gravity Operations 50%,
Spot Hidden 75%, Sneak 40%

Weapons: Piercer 50% 1D6+1D4, Laser
50% 2D10 Base Range 60 (2 shots
remaining)

Offense and Defense

Godok will tell the investigators to recover any protective devices they find on the ship. The devices fit over the head, much like high tech metal headbands. It will take Godok two hours to figure out how to fix the devices using the available parts and 30 minutes per device to get them operational (and modified for human use). It will take him four hours to figure out the weapon and get it into working order.

While he is working on the devices and weapon, he will set the crew to work jury rigging a defense by using the ship's scanner, dampening field and com systems, creating a form of static.

Jury Rigged Defense

Godok will give the investigators directions on how to change the ship's scanners, dampening field and communication systems to counter the effects of Sheb-Teth and his vessel. This requires an Electronics Roll and a Computer Use roll to get the system working. Once in operation, those within the ship will no longer be affected by Sheb-Teth's "background" Sanity damage. They will also be treated as if their POW was 6 points higher when resisting Sheb-Teth's direct attacks.

Protective Headgear

Godok will explain that the helmets protect the wearer from the influence of Sheb-Teth although they are not perfect. The protective devices completely block Sheb-Teth's "background" Sanity damage and the wearer's POW is treated as being 20 points higher, thus providing a reasonable chance of resisting. The devices will fit under vacuum suit helmets.

The Weapon

The weapon, he explains, was specially created to deal with Sheb-Teth. According to the legends, the Leioyoc wanted more than just revenge—they also wanted to free the souls that Sheb-Teth had stolen. The weapon is supposed to be able to free these trapped souls while destroying Sheb-Teth and his vessel.

The weapon is an armored box with a bonding plate on the bottom. It is equipped with carrying handles and has a timer and remote activation system (which can be activated via the ship's communication system). It is one meter on each side and weighs 150 kilograms in gravity.

The weapon's armor is made of extremely strong material, which provides it with 30 points of protection. The weapon can sustain 30 points of damage before it is broken. 60

points of damage will destroy it beyond the possibility of repair.

If an investigator who knows about the Markelson Gateway system examines the weapon, she will find some marked similarities between the weapon and the storage systems for the energy used to create the gates. This is because both systems are designed to deal with life energy.

Godok will find that it has to be recharged using life energy. It will require a total of 40 magic points. It can take 4 points each round from a willing donor. Once the weapon is charged, it will be ready to be deployed and activated. Godok will say that the device must be placed close to Sheb-Teth. Fortunately, it has an indicator that will point the way to go and show the proper placement location. Godok will add that there will probably be things trying to kill them as they head towards Sheb-Teth

Trouble on Board

If the keeper desires to throw in some stock, movie style drama, the NPC graduate student (or another NPC) can be overcome by Sheb-Teth and be forced to turn against the crew. This should not pose a serious threat to the investigators, but provides another challenge. Most players will suspect that something like this will happen, so it might be more surprising to not have it happen instead.

Into the Ship that Waits

The interior of the ship is rather disturbing. As described in the Maps section, the vessels decks, bulkheads and equipment are fused with organic material.

The interior of the ship is littered with the vacuum suited bodies of many aliens. The bacteria within the suits decomposed the bodies within them, leaving only the bones and other hard remains within them.

Facing the Dead

Sheb-Teth will sense the danger when the investigators come on board his ship. He will expend some of his energy to animate the bodies of the dead. The humans are fairly freshly dead, so they can be used as “Trojan zombies.” Sheb-Teth’s unconscious mind can take control of them and cause them to speak.

He will animate the skeletons in each area the investigators enter, reserving some of his energy to create manifestations.

Facing Sheb-Teth

The investigators will eventually reach the bridge and come face to back with Sheb-Teth. His body is badly damaged, but his visage is still horrifying. He will use the last of his reserves to manifest and try to stop the investigators. When he runs out of Magic points, there will be nothing more he can do. However, the investigators will not know this.

After the investigators place the weapon on the deck, it will burn through the flesh and fuse itself into the deck. The investigators suit radios will pick up a loud alarm sound, followed by garbled words that sound like “cri...critical...syst...syst...ov...lo...cru...te n minutes to reach mina...mina...”

The weapon will bond into the ship’s systems and cause it to expel the live energy it stole over the eons. Bright points of light will shoot from the ship and flee into the distance. Some will pause at the derelict vessels before moving on, while many others will pause at the asteroids. It will continue to drain out the energy of the vessel and then drain Sheb-Teth of life. The ship’s systems will, as the warning said, overload ten minutes after the weapon is placed. This will turn the ship into a fused wreck from which nothing but the hull material can be salvaged.

Conclusion

The adventure ends when the investigators defeat Sheb-Teth, perish or flee. If they die, the ship that waits will consume their souls and they will be trapped and tormented in horror until Sheb-Teth is finally defeated.

If they flee and leave Godok to die, their cowardice will result in a 1D6 Sanity point loss.

If they defeat Sheb-Teth, they will receive a 1D20 Sanity point award for vanquishing such an ancient and great evil. They will also be able to claim salvage right to the alien ships, which will make them very rich. If they thought to move the Comstock Lode off the asteroid before boarding the ship, they will receive a substantial reward from the company.

Godok will initially be regarded as a traitor by his fellows, but the wiser among them will quickly realize that he has redeemed their race. He will be lauded as a great hero. He will want to make the truth of the story known, saying that the true shame was in keeping the matter secret for so long.

Mythos Beings

Sheb-Teth

Great Old One

Sheb-Teth's body has human like parts, but is massively overgrown with strange flesh and machinery. The body is partially encased in what looks like armor and pieces of what seem to be a helmet are embedded in the face and head area. He has no eyes, just empty, eternally weeping sockets. The body is mostly grayish, but there are some areas that seem to be human like flesh. On the chest is a fragment of still shiny metal with the letters "TETH" on it. Near the neck is a small piece of metal that seems to resemble an insignia of rank.

In this adventure, Sheb-Teth is badly wounded and limited in his powers.

Cult: Sheb-Teth traveled from world to world, deceiving beings and leading them

onto the path of madness and violence.

Since he consumes all sentient life on the worlds he visits, he does not leave behind many cultists. Some who have learned of him worship him, either in the hopes that he will consume their enemies or not consume them. He has no interest in worshippers and exists only to take.

Attacks & Special Effects: Even in his damaged state, Sheb-Teth still has fearsome powers. First, sane beings within 100 miles of Sheb-Teth are affected by his subconscious mind and the mind of its ship. Each hour, those within this area of effect must make a Sanity check or lose 1 Sanity point. Those affected by him will fear a deep fear that seems to tap into their worst nightmares

Second, Sheb-Teth can send out manifestations. Each manifestation costs him 5 Magic Points. Once created, a manifestation will lose one point of POW every 10 minutes. When the manifestation's POW reaches 0, it will vanish.

Third, Sheb-Teth can also infuse the remains of the dead with his own energy. It costs him one magic point to animate a body or skeleton, giving it 1 point of POW.

Animated remains will remain animated for one hour. To be animated, the remains must be fairly intact. While Sheb-Teth can re-animate remains, it cannot re-animate ones that have been destroyed. He can animate remains only within his ship.

Fourth, Sheb-Teth can also detect the presence of anything with POW (typically living beings) over hundreds of kilometers, although the fineness of its discrimination improves as the distance lessens.

Fifth, Sheb-Teth can also influence the minds of others up to thirty miles away. To do this, he must expand two Magic points and match his POW against that of the target. If he wins, the target loses 1D6 Sanity points. Further, the target will be inclined to act in a way that is in accord with

Sheb-Teth's desires, although the behavior will be consistent with the character of the target. For example, someone who is greedy might be drawn aboard Sheb-Teth's vessel in the hopes of finding valuables. While the target will act with less good sense, it will not act against its nature. So, for example, a greedy person who is not violent will not kill her friends to rob them. Sheb-Teth can repeatedly attack the same target in order to wear it down. If the target goes insane, it will act in accord with Sheb-Teth's desires and will do so in a way consistent with the target's character. However, an insane victim will (obviously) act in insane ways. For example, a greedy person might decide to kill all her friends in order to take their stuff.

Sixth, Sheb-Teth can be healed by his ship. If he is damaged, the ship can repair such damage. The ship can heal ten points of his damage each round, even if Sheb-Teth is "killed." The ship cannot, however, restore him to full consciousness. This is because his mind is part of the ship and the ship has been crippled beyond its power to repair itself. If it were able to consume roughly one thousand living beings, it would be able to restore itself enough so that Sheb-Teth would awaken once more. That would be very bad.

Sheb-Teth, Devourer of Souls

STR: 26 CON: 30 SIZ: 26 INT: 16
 POW: 30 DEX: 14
 Move:- HP: 28 DB: +2D6
 Weapons: None
 Armor: 20 points of armor plating and overgrowth.
 Spells: None

Sanity Loss: 1D6/1D20 Sanity points to see Sheb-Teth.

Manifestation of Sheb-Teth, Lesser Servitor Race

<i>Char</i>	<i>Rolls</i>	<i>averages</i>	Whipple	Chopak	Wing	Guder
STR	3D6X1.5	15-17	17	15	18	16
CON	3D6X1.5	15-17	18	16	19	17
SIZ	2D6+6	13	16	11	15	14
INT	-	-	-	-	-	-
POW	1	1	1	1	1	1
DEX	2D6	7	8	10	6	7
Move						
8						
HP		14-15	17	14	17	16
DB		+1D4	+1D6	+1D4	+1D6	+1D4

Sheb-Teth can project his energy to create manifestations. The manifestations are created somewhat randomly by his subconscious mind. They resemble his main body, but are fully humanoid and typically have nightmarish claws and teeth. Some have eyes, some do not. They often appear to be wearing pieces of some sort of advanced armor and they sometimes have distinctive human features, such as a human arm or partial face.

Sometimes a manifestation will appear that looks like a human in advanced armor. The figure will quickly distort and become a hellish figure of twisted flesh, machinery and melted armor.

Sheb-Teth, Manifestation of

<i>Char</i>	<i>Rolls</i>	<i>averages</i>
STR	3d6+6	16-17
CON	3D6+6	16-17
SIZ	3D6+6	16-17
INT	3D6	10-11
POW	5	5
DEX	3D6	10-11
Move 8		HP 16-17

Av. Damage Bonus: +1D4-+1D6

Weapons: Claw 50% 1D8+DB, Bite 1D8

Armor: 10 points of armor

Sanity Loss: 1/1D8 to see a Manifestation of Sheb-Teth.

Animated Corpses, Lesser Servitor Race

Description: These beings are zombies animated by the will and power of Sheb-Teth. In life these specific zombies were Robert Whipple, Jane Chopak, Chu Wing, and Helga Guder. Sheb-Teth can guide their actions with part of his subconscious mind. Sheb-Teth's cleverness operates even as he "sleeps" and he can direct the corpses to speak and act in intelligent ways in attempts to deceive the investigators. The vacuum suits conceal their flesh and their clumsy movements can be attributed to the lack of gravity.

Animated Corpses, Walking Dead

Weapons: Matok LC-17 30% or Beretta LP-24 30% 1D10, Punch 50% 1D3+1D4 Kick 25% 1D6+1D4, Grapple 25%

Armor: 12 point space suit plus impaling weapons do 1 point and all others do half

Char	Rolls	averages	#1	#2	#3	#4
STR	3D6	10-11	12	10	11	13
CON	-	-	-	-	-	-
SIZ	2D6+6	13	14	13	12	15
INT	-	-	-	-	-	-
POW	1	1	1	1	1	1
DEX	3D6	10-11	13	11	14	10
Move	8					
HP	-	-	-	-	-	-
DB	+0	+0	+0	+0	+0	+1D4

damage.

Spells: None

Sanity Loss: 1/1D8 to recognize and animated corpse as such.

Alien Skeletons, Lesser Servitor Race

The animated skeletons are from various alien races but most of them are roughly human in size. They still wear their vacuum suits, although some of them are tattered and worn. For the sake of simplicity, they are treated the same. Being animated bones,

they are immune to criticals, impales and such. Instead, each successful attack has a 4% chance per point inflicted of shattering the skeleton.

Animated Skeletons, Alien Dead

Weapons: Fist 50% damage 1D3+db or bludgeon 1D6+db

Armor: 6 point space suits

Skills: Low/Zero Gravity Operations 50%

Spells: None

Sanity Loss: 0/1D6 to see an animated alien.

Animated Ga'Thos Skeletons, Lesser Servitor Race

The Ga'thos are much larger than humans and evolved from carnivorous predators. In addition to the size difference, they have four legs. They have a double pelvis rather than a longer body, so they stand upright. They are well equipped with claws and sharp fangs. A scout vessel crewed by Ga'thos fell victim to Sheb-Teth. Because of their large size and natural weapons, Sheb-Teth will animate them as combatants. Being animated bones, they are immune to criticals, impales and such. Instead, each successful attack has a 4% chance per point inflicted of shattering the skeleton.

Animated Ga'Thos Skeletons, Large Alien Dead

Char	Rolls	averages	#1	#2	#3
STR	4D6	14	16	18	20
CON	-	-	-	-	-
SIZ	3D6+6	16-17	18	19	22
INT	-	-	-	-	-
POW	1	1	1	1	1
DEX	3D6	10-11	11	10	14
Move	8				
HP	-	-	-	-	-
DB	+1D4	+1D4	+1D6	+1D6	+2D6

Weapons: 2 Claws 50% damage 1D6+db and Bite 40% 1D8

Armor: 10 point space suits

Skills: Low/Zero Gravity Operations 50%
Spells: None
Sanity Loss: 0/1D6 to see an animated
skeleton.

NPCs

Richard Jones 42, First Officer

STR: 14 CON: 14 SIZ: 14 INT: 13
POW: 12 DEX: 12 APP:12 EDU:15
SAN: 00 HP: 14 DB: +1D4

Skills: Accounting 20%, Astronomy 41%, Computer Use 41%, Electrical Repair 25%, Electronics 51%, Gunnery 35%, Fast Talk 25%, Law 15%, Navigate 50%, %, Low/Zero Gravity Operations 40%, Persuade 40%, Physics 21%, Pilot Space Ship 51%, Psychology 15%, Zero Gravity Mining 61%

Weapons: Matok LC-17 30% or Beretta LP-24 30% 1D10, Punch 50% 1D3+1D4 Kick 25% 1D6+1D4, Grapple 25%

Description: Jones has short brown hair, a small moustache and brown eyes. He is short, but solidly built. Before being driven mad by Sheb-Teth he was a competent first officer. Unfortunately, his competence is now in the service of Sheb-Teth, making him a minor threat to the investigators. Jones believes that he has been wrongfully denied a command of his own and concealed a great deal of bitterness and resentment in regards to this. Sheb-Teth was able to feed that resentment and twist his mind so that he wanted to have complete control over the Comstock Lode. He now thinks that he has his rightful command. In his mind, Sheb-Teth has given him this command and he must maintain Sheb-Teth's good will to stay in command. As such, he acts in accord with what he takes to be the will of Sheb-Teth.

Rita Trask 23, Graduate Student

STR: 12 CON: 12 SIZ: 13 INT: 14
POW: 10 DEX: 12 APP:13 EDU:14
SAN: 50 HP: 13 DB: +1D4

Important Skills: Accounting 20%, Computer Use 31%, Biology 21%, Chemistry 41%, Drive 40%, Fast Talk 25%, Geology 51%, History 60%, Library Use 75%, Natural History 40%, Persuade 35%,

Planetology 41%, Psychology 25%, Physics 51%

Weapons: Beretta LP-24 30% 1D10, Punch 50% 1D3+1D4, Kick 25% 1D6+1D4, Grapple 25%

Description: Rita is a young graduate student. She has curly black hair and brown eyes. She is quite thrilled to be working with Godok. She hopes to follow in his footsteps and become a professor in the same field.

Dr. Godok E'Peth 51, Scientist

STR: 5 CON: 11 SIZ: 12 INT: 18
POW: 16 DEX: 12 APP:12 EDU:20
SAN: 75 HP: 13 DB: +0

Important Skills: Computer Use 81%, Biology 31%, Chemistry 61%, Cthulhu Mythos 5%, Fast Talk 25%, Geology 91%, History 60%, Library Use 75%, Natural History 40%, Occult 15%, Persuade 35%, Planetology 91%, Psychology 25%, Physics 91%

Weapons: Punch 50% 1D3+0, Kick 25% 1D6+0, Grapple 25%

Description: Godok is a well respected expert in the field of planetary breakup. He received the equivalent of a doctorate on his homeworld and then completed another one at M.I.T. Godok has a surprising sense of humor for a professor and is well liked by his students, human and non-human. Unlike most of his race, he has a desire for adventure and handles danger reasonably well. He is described in more detail, above.

Epilogue

Human scientists soon arrived to study the alien vessels and the remains of Sheb-Teth's ship. The scientists who worked for Lee Industries were shocked to find that many of the aliens appeared to have been killed by something resembling the weapons technology they were developing from what was found on Richard's world. Wishing that more remained of the Sheb-Teth's ship, they contented themselves by studying the alloys

that remained from its fused hull. These findings enabled them to introduce significant advances in hull technology.

The findings in the alien ships also enabled new advances and provided humanity with useful data about alien species they had yet to encounter.

There was significant speculation about the origin of Sheb-Teth and his ship. During high level discussions about the matter, it was pointed out that highly advanced starships are generally built by civilizations. This fact led some to worry that others of Sheb-Teth's race still existed and would pose a great threat to the universe. They did not realize how right they were.

Handouts

Handout #1

The Celfos System

-Public Data Net

Little is known about the system itself beyond the data gathered by robotic probes and an initial survey. The orbit in the habitable zone of the system is full of asteroids. The best evidence is that the world in that orbit broke apart, perhaps due to internal instability or due to an impact. Science teams have expressed an interest in studying the asteroids, but no team has been sent yet.

The rest of the system is fairly standard-uninhabitable worlds and one gas giant. No signs of civilization or aliens were found, but, of course, a system is a big place.

Handout #2

Drapathi

-Vanguard Public Data Net

The Drapathi were first encountered seventy five years ago when CEA probes entered their solar system and detected radio signals and orbital structures. In accord with CEA policy, a manned expedition was sent to observe the system. After this period of observation, contact was made with the Drapathi.

While it was initially suspected that the Drapathi were behind humanity in technological development, it was soon determined that they have possessed the capacity for interstellar travel for centuries. While the Drapathi have creativity and curiosity on par with humans, their interests tend to be within the areas of theoretical sciences, philosophy and the arts. As such, their explorations tend to be inward and theoretical rather than out into the vast realms of space.

This difference between humans and Drapathi has proved beneficial to both races. For example, Drapathi scientists are always eager for the empirical data provided by human scouts and human science has benefited greatly from Drapathi research.

Social and political scientists also point out that the fact that the Drapathi are non-expansionist makes them unthreatening to humanity, thus allowing the two races to get along.

Physically, Drapathi are quite different from humans. Because their home world has approximately half the gravity of earth, they are physically weaker than humans. Their body structure is also quite different in that they have eight limbs and six eyes. Unlike humans, the Drapathi can use all eight limbs to manipulate objects. Like humans, they have two eyes with excellent color vision. However, they also have one set of what they call “night eyes” that provide excellent vision in low light conditions. Their other set of eyes, which is located on the lower end of their bodies, provides only rudimentary vision-mostly just rough shapes and motion.

Like humans, Drapathi have endoskeletons. However, they also have a tough outer skin that protects them from both physical harm and UV radiation. Their sun emits more radiation than earth’s sun and their atmosphere is thinner, hence the need for thicker skin. While Drapathi and humans look odd to each other, neither race finds the other disturbing. The Drapathi, being hairless, find human hair to be a bit odd. One well known Drapathi comedian incorporates wigs into his act, much to the delight of his audiences.

Also like humans, the Drapathi evolved from omnivores. However, the Drapathi are far more efficient at digesting plant material than humans, thus they were more often gatherers than hunters. Some scientists speculate that this affected their social development and made them less aggressive than humans.

The Drapathi have two sexes (male and female). Drapathi females are, on average, larger and more outgoing than the males.

While the Drapathi tend to prefer to remain in their own system, some of them do enjoy visiting human worlds. Those that find living among humans appealing typically take teaching or research positions with universities or companies. Artistic Drapathi also find ready employment on human worlds. While there are aesthetic differences between the two species, most humans find Drapathi art pleasing. Their sculptures are especially popular. Their music, however, is generally not well appreciated by humans. Most critics say that this is because their music is too subtle and harmonic for most humans.



Handout #3

Comstock Lode Crew Roster

Captain: Hannah Brooks

First Office: Richard Jones

Engineer Tonya Trey

Survey Team: Robert Whipple, Jane Chopak, Chu Wing, and Helga Guder

Pilot: Goban Riles

Navigator: Kevin Stepolopus

Co-pilot: Kathy Burt

Engineer: Theodore Gupta.

Medical/Science: Linda Rifkin

Ship's AI: Number Seven

Players' Material

Use the equipment list and information from "Dust" with the following additions:

Equipment

Weapons

Matok LC-17

Starting Skill: 25% Damage Done: 1D10
Base Range: 60 yards Attacks Per Round: 2
Ammunition: 40 HPs resistance: 10
Malfunction: 00

The Matok LC-17 is a laser carbine (use rifle skill). It was originally developed as a light weapon for second line military personal, but quickly spread into the civilian market. The most popular feature of the Matok LC-17 is the fact that its power output can be adjusted. While this significantly increases its power usage and the chance of a modulator burn out, it does enable the weapon to inflict considerable damage. The following chart shows the effects of increasing the power output. If the weapon malfunctions, the modulator burns out. It can be replaced, but doing so requires the use of mechanical repair.

Ammunition Expended	Damage	Malfunction
4	2D10	95
8	3D10	85
16	4D10	75

The Comstock Lode

The Comstock Lode is a Gold Rush class survey and mining vessel. The class was designed to survey and mine asteroids using a complement of drones. The designers elected to include an AI in place of a standard computer, primarily to provide constant control and monitoring of the drones. While there have been some attempts to fully automate the surveying and

mining process, past experiences have shown the value of having a human crew on hand. As such, the Gold Rush class ships carry a human crew.

Because the ships operate in isolated areas and gather valuable minerals, the designers decided that the ships should be armed. Standard armament consists of two dual laser turrets. The lasers can also be adjusted for mining operations, such as cutting through asteroids.

Like all modern starships, the Gold Rush class ships have artificial gravity and a Markelson Gateway System. The hatches on the ship are, of course, air tight and manually operated. There are automated safety systems to prevent the airlocks and hatches from exposing the interior of the ship to vacuum. Gold Rush class ships carry a shuttle craft for scouting missions and as an emergency lifeboat. While not intended for operation in an atmosphere, ships of the class have enough thrust to make powered landings on planets.

Deck Plans

Turret 1: This dual laser turret is located on the belly of the ship and is accessed via a floor hatch on deck one. The interior of the turret provides access for maintenance and has a gunner station. The turret can also be operated from the bridge or by the ship's AI.

Turret 2: This turret is located on the top of the ship and is accessed via ceiling hatch in deck two. It is otherwise the same as turret one.

Deck One

1. Shuttle Bridge: This is the bridge of the shuttle. It has one station for the pilot and one for the co-pilot.

2. Shuttle Seating/Cargo: This is the seating and cargo area. The seats can be

folded down into the deck to convert the area into a cargo space.

- 3. Shuttle Locker & Airlock:** This area contains a small equipment locker and the shuttle's airlock.
- 4. Locker:** This is an equipment locker that holds surveying equipment, spare parts for the shuttle and tools.
- 5. Airlock:** This is an airlock.
- 6. Locker:** This is an equipment locker that holds surveying equipment, spare parts for the shuttle and tools.
- 7. Common Area:** This common area can be configured with exercise equipment or entertainment equipment.
- 8. Stateroom:** A standard stateroom.
- 9. Galley:** The ship's food preparation area.
- 10. Stateroom:** A standard stateroom.
- 11. Stateroom:** A standard stateroom.
- 12. Head:** The bathroom.
- 13. Stateroom:** A standard stateroom.
- 14. Parts Storage:** This area holds tools and parts for repairing the ship's systems.
- 15. Corridor:** The access corridor. There are access hatches to turret 1 and deck two.
- 16. Port Engineering Access:** This area provides maintenance and repair access to the ship's power systems.
- 17. Starboard Engineering Access:** This area provides maintenance and repair access to the ship's power systems.
- 18. Gateway Engineering:** This area has a security lock on the door and provides access to the ship's Markelson Gate System.

Deck Two

- 1. Bridge:** The command area of the ship. It has stations for the command crew, drone control stations and work areas for assessing survey data.
- 2. Captain's Stateroom:** This is the captain's stateroom and office.
- 3. Conference Area:** This area is for crew meetings. It also serves as a common area.
- 4. Stateroom:** A standard stateroom.
- 5. Stateroom:** A standard stateroom.

- 6. Common Area:** A common area. This area can be configured for exercise or entertainment. It also serves as the ship's sick bay, should the need arise.
- 7. Stateroom:** A standard stateroom.
- 8. Stateroom:** A standard stateroom.
- 9. Head:** A bathroom.
- 10. Stateroom:** A standard stateroom.
- 11. Suit Storage:** Vacuum suits are stored here.
- 12. Port Docking Arm/Airlock:** The docking arm can extend to link with other ships. The docking system is adjustable, allowing the ship to connect with most other vessels.
- 13. Starboard Docking Arm/Airlock:** A docking arm.
- 14. Corridor:** The main corridor of the deck.
- 15. Drone Bay 1:** The drone bay holds twenty mining drones. Access is via an airlock. There is also an external bay door for launching the drones. The area can be pressurized for maintenance, but is usually kept in vacuum.
- 16. Drone Bay 2:** This drone bay holds twenty mining drones.
- 17. Drone Bay 3:** This drone bay holds thirty survey drones.
- 18. Drone Bay 4:** This drone bay holds thirty survey drones.
- 19. Main Engineering:** This is the ship's main engineering. This area provides access for maintenance and repair. There are also controls for the ships drive and power systems.
- 20. Port Engineering Access:** This area provides maintenance and repair access to the ship's drives.
- 21. Starboard Engineering Access:** This area provides maintenance and repair access to the ship's drives.
- 22. Aft Airlock:** This airlock is used primarily when the engineer needs to examine the ship's drives from the outside.

The Third Era

The following provides some general background for the third era. The third era begins approximately 500 years in the future. Whereas the first era was defined by humanity leaving earth and the second era was defined by massive colonial expansion, the third era is defined by a great and terrible war that began on the colony world of Reblis and spread to involve all humanity.

The Time

At the dawn of the third era, humanity has established itself on approximately one hundred worlds (“the One Hundred Worlds of Man”). While there are still problems and a few minor wars, humanity has largely settled into a time of peace, prosperity and success.

As so often happens, this success has bred complacency and corruption. The Colonial Governmental Authority is an overweight bureaucracy that does more to impede progress than further it. While some local forces in the Colonial Military Authority remain excellent, the overall quality of the armed forces has declined. Corporations now regard military contracts as a given right and the quality of armaments has declined severely. The Colonial Exploration Authority has been subverted by corporate lobbyists and now sets its policies based on corporate needs, rather than on the general good of humanity.

Despite the rot accumulating in the halls of bureaucracy, most of the colony worlds remain healthy. However, political and social scientists warn that the rot will spread if it is not checked. As usual, some doomsayers predict that a terrible crisis is just around the corner.

Adventure Four: Once Men, But No More

Introduction

This adventure places the investigators into an “end of the world” scenario. While their world is doomed, the investigators will have a chance to save the rest of humanity from the same fate. Pre-generated characters have been provided, below.

Keeper’s Background

Undaunted by the dangers of space, humanity continued to expand ever outward. World after world came under the dominion of man and it seemed like humanity would expand, perhaps even to the edges of the galaxy. Despite the hardships faced on some colony worlds, it was a time in which the triumphs of humanity created a sweeping sense of optimism and hope. It was, by all accounts, a golden age. But, as with all golden ages, doom and darkness were waiting.

As is so often the case, the coming darkness began on a positive note. Robotic probes, sweeping through the Reblis system, reported an amazing discovery: a rich, earth-like world that could be terraformed with minimal effort. Manned scout vessels were dispatched to the system and they made yet another amazing find: the world had been the site of a small non-human colony. Although all that appeared to remain of the colony was surface ruins and a few intact underground chambers, the find created quite a stir in the scientific community. It also created quite a stir among those who were eager to see a colony on the world—they feared that the presence of the ruins would result in a postponement or even the cancellation of the colonization process.

After careful investigation, the Colonial Science Authority decided that colonization

could still take place, although the alien ruins were placed off limits. Since the area occupied by the ruins was relatively tiny, no one really minded this restriction.

Due to the abundance of valuable resources, the colony was able to grow very quickly. Within a few decades, the colony was a thriving commercial center that provided raw materials and manufactured goods to nearby colonies.

The ruins, which would later doom the colony, initially proved beneficial. Xenotourism, while a niche market, occasionally attracted wealthy eccentrics who contributed to the local economy. Further, additional exploration of the ruins revealed a series of underground chambers holding records and artifacts. While most of the contents of the chambers were broken and damaged, the find was still considered very significant. This led Harvard University's Xeno-Archeology Department to establish a research center near the ruins. This added to the world's prestige and its economy.

With the data gained from the additional discoveries, the Harvard researchers were able to devise a "signature" for the race that had once inhabited the world. This signature was then programmed into new robotic probes to assist them in finding signs of the race. While the robotic probes ranged far and wide, no additional sign of the race was detected. This led to a great deal of speculation about the origin and the fate of the alien colonists. One popular theory proposed that the colony was founded by a lost ship and the colonists were later removed by another vessel. Another popular theory, based on the presence of what seemed to be religious writings and items, was that the colony was founded by a religious sect which sought (or was forced to seek) isolation. As far as the end of the colony, some theorists proposed that the sect practiced abstinence and simply died out.

Others considered the possibility that it was an alien Jones town.

The underground chambers yielded many interesting finds, but a chance discovery led to the greatest (and ultimately most horrible) find. While the official version tells a different story, the discovery took place when two graduate students accidentally triggered a hidden door while having sex. After pulling on their clothing, the students went through the door and found a series of chambers containing intact records and items.

The students spent the rest of their careers puzzling out the secrets of the chamber. When not engaged in research, they were busy raising their daughter, Marie Logan. Marie followed her parents' footsteps and earned degrees in xeno-archeology and xeno-biology.

While other scientists were largely baffled by the writings of the aliens, Dr. Logan had a special insight into their language and thought. Part of this was due to a mundane cause-she had grown up exposed to her parents' work. Part of this was due to an unnatural influence-as she grew up, strange forces shaped her mind. As she grew older, she would sometimes hear alien words whispered in her head. She attributed these to her subconscious, and after reading Plato's writings, noted that even Socrates claimed to have heard a voice in his head. Hence, she was unconcerned about her "little voice." In reality, she was being carefully guided by outside forces to become an instrument for their terrible purposes.

Dr. Logan, guided by the whispered words and aided by her education, finally managed to crack some of the alien writings. She learned the colony had been created by a race known as the Salbucek. She also found within the writings highly advanced information about genetics and gene manipulation. She, however, did not fully grasp the true meaning of the writings and

believed the colony had been a benign research outpost. Initially, she believed that she had found a means to make humans better, faster, stronger and nearly immortal. Hoping to bring this great benefit to humanity, she sought funding for additional research. While most were generous with their skepticism and stingy with their cash, she finally received the support she needed from the extremely wealthy, but weak willed, Mark Wells. To ensure that his support remained unwavering, she decided to marry him and he readily yielded to her request. With secure financing from her husband, she continued her research and made great advances in her studies.

It was during this time that her sanity melted away under the influence of the ever louder and more numerous voices in her mind. These voices guided her to horrible documents that served to devour even more of her sanity. It is through these writing that she learned the terrible truth about the colony.

Long ago, the Salbucek mastered the same basic technology used in the Markelson Drive. Like humanity, they expanded outward into space. Also like humanity, they had long been plagued with various strange religions and cults. One of these cults, known as the Chosen of Nythe, gained considerable popularity among some of the wealthy and educated before the true horrors behind it were exposed. While the group presented itself as devoted improving the race, in actuality the leaders were under the thrall of unspeakable beings of madness and horror that lurked beyond our space-time. These beings had once moved freely from their realm into ours, but when the stars changed, they found themselves barred from returning.

Desiring to return, but unable to do more than reach out with their minds, they sought to find those who would be willing and able to set the stars right once more. They found

such people among the Salbucek and thus the Chosen of Nythe arose.

The Chosen were guided by their unseen masters to use the advanced biological sciences of the Salbucek to remake the race over in the image of these horrible masters. The new race would be known as the Children of Nythe. The Children would then have the means and the will to make the stars right again, thus allowing their “parents” to return.

Fortunately, the cult was exposed before its plans could come to fruition. The authorities, at least those who were free of its influence, took swift and violent action that almost exterminated the cult. Unfortunately, a small group of cultists was able to escape and start a colony on Reblios.

When the colony was founded, the masters of the cultists accepted that the Salbucek would not be the means of their return. Hence, they directed their thralls to prepare for the day when another race would arrive-a race, it was hoped, that would be able to set the stars right once more.

While many of the cultists accepted this turn of events, some bitterly resented what they saw as a betrayal of their destiny. Not surprisingly, this led to a violent division in their ranks. While the loyal cultists constructed hidden chambers and stocked them with the items and writings their successors would need, the dissenters decided that they would start the transformation process on their own. In their deranged minds, the turn of events was but a test and they decided they would reveal the purity of their faith by acting upon the original plan.

So, as the loyalists were finishing the hidden chambers, the dissenters released a viral agent carrying the genetic coding intended to remake the race. Unfortunately for all the cultists, the coding was incomplete and seriously flawed. Rather than becoming the Children of Nythe, they



were transformed in haphazard ways and most were reduced to mere beasts that lusted only for death and destruction. Thus, the colony perished in a frenzy of brutal violence.

After learning this, Dr. Logan almost found the strength to resist the voice in her mind. But, as the last of her sanity vanished, she resolved to succeed where the cultists had failed. She knew that she would have to be subtle in her methods and move gradually towards her goal. After all, the human authorities would act as the Salbucek authorities had, should the truth be revealed prematurely. As such, she began by attempting to win the good will of the people by providing new cures and treatments based on the alien technology.

This initial project was a great success and she was able, over the course of a decade, to recruit an inner circle of scientists, politicians and other influential people. The inner circle members were told of a master plan to improve the human race but not the true intent of this plan (which was to transform humans into the Children of Nythe). She carefully observed the members of this group and, over the course of another decade, revealed more of the truth to those who seemed most likely to embrace the real plan. Those who had learned too much, but were unwilling to join her, met with “unfortunate accidents.”

While Dr. Logan had lost her sanity, she did not lose her scientific mindset. As such, she set some of her researchers to work on a counter to the transformation process. This was not due to second thoughts about the rightness of her decision. Rather, her intent was to avoid the sort of disaster that had destroyed the original Chosen of Nythe.

Like much of the work on Dr. Logan's project, the development of the counter agent was assigned to innocent researchers who believed they were working to help humanity. In this case, the scientists were

told they were doing research on an antidote to biological weapons (which was, in a way, the truth).

A brilliant young researcher assigned to the counter agent project, Dr. Kate Krishnan, discerned that the project was designed to counter a very specific type of DNA alteration. Using what she had learned, she was able to reconstruct the nature of the alteration. Startled and horrified by what she had found, she considered bringing her findings to the attention of her supervisor. However, she elected to start an investigation on her own. This was partly because she feared that the supervisor might be involved in something sinister and partly because she feared she might be making much ado about nothing and did not want to seem a fool.

While she was only able to uncover but a small portion of Dr. Logan's plans, she learned enough to convince her that Dr. Logan intended to infect the population of Reblis with a horrible DNA altering agent. When she also learned that many of the colonial elite seemed to be in on the plot, Dr. Krishnan decided that she would have to take matters into her own hands.

While Dr. Krishnan was making her terrible discoveries, Dr. Logan's work continued. She completed the final tests of the transformation agent and her minions set to work preparing the delivery systems. The bulk of the delivery would be carried out by aircraft—they would simply spray the agent over the inhabited areas of the planet. Dr. Logan did, of course, face some serious challenges. Many military and governmental facilities were protected against such attacks. Further, some military assets were in orbit, thus quite safe from airborne attacks on the world below. Dr. Logan realized that if the military remained untransformed, then her plans could well be undone. To ensure that the military was infected, she devised a clever plan. The centennial anniversary of

the colony was fast approaching and massive celebrations were planned. She arranged for her husband's companies to donate beverages, laced with the transformation agent, to the military for this celebration. She also had his propaganda people convince the colony president to propose that everyone on the planet drink a simultaneous toast to the centennial. Conveniently, the bio-scanners used to check incoming shipments for threats had been designed by her people and hence would be easily re-programmed to ignore the agent. As such, the world would end not with a bang, but with a toast.

Getting the Investigators Involved

The following details how the investigators will be drawn into the adventure and what they will know prior to the start.

Dr. Kate Krishan

You were thrilled to be hired by Dr. Logan's research company. After all, she had given the world numerous amazing breakthroughs in genetics and working for her would be an amazing opportunity. You were proud and pleased when you were hand picked by her to work on a special project. This project was designed to counter a very specific type of DNA alteration. Ever curious, you set out to reconstruct the nature of the alteration. Much to your horror, you found that the DNA alteration process would transform a human into something quite inhuman. Startled and horrified by what you found you considered bringing your findings to the attention of your supervisor, but decided not to do so. In part, you were afraid that the supervisor might be involved in something sinister. You also feared you might be making much ado about nothing and did not want to seem a fool.

Further investigation revealed to you a something you would have thought

inconceivable: Dr. Logan intended to infect the population of Reblios with the horrible DNA altering agent. Much to your dismay, you also learned that many of the colonial elite seemed to be in on the plot. You decided at that moment to take matters into your own hands.

After verifying your findings, you stole a supply of the counter-agent. Then you contacted your college roommate, Desiree Cheever, who worked as a top reporter for the Reblios news service and provided her with evidence for your claims. Unfortunately, things did not work as they did in the action stories you love so much.

As you were on your way to the family cabin, you received a warning call from Desiree saying that her computer had been locked by the police and that a warrant had been issued for you. According to the warrant, you had been exposed to a dangerous agent at work that made you psychotic and led you killing two co-workers. Naturally, the agent was supposed to be infectious and hence the public was warned that you were both insane and a contamination hazard.

You called your brother, a Captain in the Reblios Army, and told him that the warrant was a lie. Believing you, he said he would meet you at the cabin with two of his soldiers.

After reaching the cabin, you begin to nervously wait. You hope your brother makes it before the police do.

Desiree Cheever

Though you grew up in fairly humble circumstances, life has been good. After breaking two stories about corporate corruption, you were given a top post in the Reblios News Network. Thousands of people now know your face, even though it isn't quite the one you were born with. Heck, you figure, sometimes nature needs a helping hand.



Your old college roommate, Kate Krishnan, called you to say that she had exposed something truly rotten in the company where she worked. Always glad to help a friend, and hoping for that third great story, you came to her aid.

You weren't surprised when the police locked out your computer. That happens, even on a democratic world like Reblios. Of course, it was especially ironic given that today is the centennial celebration for the colony—a century of freedom. However, you were startled when a warrant was issued for Kate's arrest. And not just any warrant, but one issued in accordance with the biohazard regulations. The official story was that she was infected in the laboratory and went psychotic, killing two co-workers. The story says that she is infectious and mad. You don't buy it for a second—she was perfectly lucid when you spoke with her. You know that the corporation is up to something dirty. They mean to hurt your friend and the people of Reblios. Naturally, you will not stand for it.

Getting one of the news Hoppers from the company lot, you fly towards the cabin. You only hope you can reach your friend before the police silence her.

Amy Rice and Logan Jones

You are both good cops, dedicated to the public good and willing to do what it takes to enforce the spirit of the law. Fortunately, Reblios is a fairly law abiding planet and major problems are few and far between.

You figured you'd be helping out the uniformed officers, what with the centennial celebrations and the inevitable combination of alcohol and explosives that will occur. Then you got the call.

Apparently, one of the biotech companies had a horrible accident. One of their top people, Dr. Kate Krishnan, was exposed to something awful, went nuts and killed two coworkers. She then busted out of the lab

and is now on the loose. Naturally, she's infected and crazy.

You tap into the communication network and isolate her comm. She's talking with that reporter, Desiree Cheever. Strangely, she seems lucid and fairly calm. Maybe, you think, something isn't quite right. Well, you'll get things sorted out.

You pull two protective suits and get into your Hopper. The signal lock is solid, so you'll have no problem finding her. A SWAT team is on standby, just in case.

While on your way, you get an order to return. You ask for the authorization and it comes from way up the mountain. You don't like that at all. Your instincts tell you something is wrong.

You could play it safe and turn around. You look at your partner, you both smile and you stay on course. Maybe you've just made a career ending mistake, but you didn't join the force to play it safe or let people get walked on.

Captain Alberto Krishnan

Your sister has always been the smart one in the family. When you were playing with your toy guns, she was learning how to splice DNA. While your sister was smart kid, she sometimes got into trouble. But you were always there to help her out and protect her.

You both went to college, but you decided to pursue a career in the military while she went on to graduate school.

Today started like yesterday. You were up early, checking the reports and then going to review the troops. Today you'd be parading down the streets of the city, celebrating the century mark for the colony. Then you got the call. Your little sister was in trouble once more, but this time it was something big.

Not being a scientist, you didn't quite get all the stuff she said about DNA reconfiguration, amino acids and cellular alteration. But, you did the gist of it-

something terrible was being done. She then told you that the police are after her, saying that she is infected and crazy.

You don't know what the police are up to, but you know your little sister is in danger and you're the big brother who looks out for her.

You call the Colonel and tell her you have to go off base for a bit. You assure her that the men are ready to "march pretty" in the parade and that you'll be back in time. Against regulations, you pick up your sidearm as you leave. As you head towards a Hopper, you have a bad feeling and call your best lieutenant and sergeant and ask them to come along with you. They are good soldiers and good friends. They don't ask why; they just get in the hopper.

Lieutenant Yoko Donovan

You are swamped in forms when the captain calls you. He seems worried. He hesitates, and then asks you to get Dwight and meet him at the Hopper field.

You sense that something is very wrong. But, you trust the captain. You call the sergeant and he says he is on his way.

You have a bad feeling and you slide your pistol into your jacket before leaving.

Sergeant Dwight Toben-Albertson

You are checking out the weapons locker when Lieutenant Donovan calls you. She's green, but will shape up into a good officer. She says that the captain wants you to come with him. She says that it isn't army business, so you can say no.

The captain is one of those rare people-an officer who knows the right thing and does it. So, if he needs you, then you sure are going to be there.

You tell the weapons that you'll be back, pat your pistol and head towards the Hopper field.

Maps

The following details the maps.

Cabin Map

The following details the cabin, a pleasant vacation spot for the Krishnan family.

First Floor

Dining Room: The dining room contains a table.

Living Room: A standard living room with furniture and an entertainment module.

Closet: A closet.

Kitchen: The kitchen.

Second Floor

Closet: A closet.

Bathroom: A bathroom.

Bedroom 1: A bedroom.

Bedroom 2: A bedroom.

Cabin Area Map

This shows the location of the cabin in the woods.

Cabin: The cabin.

Stream: A stream.

Woods: Woods.

Base Main Map

This details the base.

1. Gate: This is the main gate of the base.

2. Guard Post: These are guard posts. They are normally manned by soldiers.

3. Barracks: The barracks for the base.

4. Barracks: The barracks for the base.

5. Common Building: This is the common building for the base. It has the main weapon locker, the mess, and other facilities.

6. Motor Pool: The motor pool and maintenance area for the base.

7. Command Bunker: This is the command bunker.

Command Bunker Interior

The command bunker is an armored structure and serves, as the name states, as



the command center for military operations in the area. When the defense systems sense a chemical or biological threat, the bunker seals and goes onto an internal air supply. Unfortunately, the detection systems were programmed not to react to the transformation agent.

- 1. Air Lock:** The entrance is an airlock designed to keep out biological and chemical agents when it is sealed.
- 2. Corridor:** This is a corridor.
- 3. Quarters:** This is the living quarters for an officer.
- 4. Colonel's Quarters:** The quarters for the base commander.
- 5. Quarters:** This is the living quarters for an officer.
- 6. Quarters:** This is the living quarters for an officer.
- 7. Quarters:** This is the living quarters for an officer.
- 8. Bathroom:** The bathroom.
- 10. Common Area:** A common area.
- 11. Mess Hall:** The mess hall for the bunker.
- 12. Operations A:** An operation room. This area is used primarily to control drone vehicles and to maintain contact with the individual squads and vehicles.
- 13. Operations B:** An operation room. This area is used primarily to control drone vehicles and to maintain contact with the individual squads and vehicles.
- 14. Control Room:** This room houses the non-AI computer systems. The base AI, Athena, has her own buried bunker offsite.
- 15. Weapons Locker:** The Captain has the code and a key for this locker. It has 6 GAR-3s (4 magazines each), 6 RGL-9s (100 grenades), 12 GP-5s (4 magazines each), 6 suits of combat armor, 12 armored vests, 12 medical kits, and 12 Smart Targeting System VIIs.
- 16. Command Room:** This is the command room for the bunker. The staff officers guide military operations from here.

Action Part I: The Cabin

The following provides a guide to the action in the adventure.

At the Cabin

The action opens with Dr. Krishnan at the cabin and the others heading towards her. While she is at the cabin, she will be nervously checking her scanner. The following will happen:

“You pace back and forth nervously. You try your comm again, but it is still blocked from the network. Will your brother and friend get here in time? As your scanner reacts, you realize that the answer is ‘no.’ Checking the instrument, you see that the agent has just been dispersed into the atmosphere. Turning the sensor towards your body, it reveals that you are already infected and changing.

You pause for a moment and then pull out the injector. You know that the counter-agent is a death sentence, but at least you will die human. You press the injector against your skin. Everything feels the same, but you know that there is now a war in your body. The counter-agent will win, but in doing so it will kill you before the end of the day. But maybe you can do something that will make a difference before then.

You haven't seen what a transformed human will look like, but the data makes it clear that it will be monstrous in mind and body. You believe you've made the right choice.

When your brother and friend arrive, you'll have to offer them the choice between transformation and death. You have nineteen more injectors...nineteen choices.”

Arrivals

Captain Krishnan and his soldiers will arrive first. Shortly thereafter Desiree Cheever will arrive and then the detectives.

If no one is playing the detectives, they can either be run as NPCs or left out of the adventure.

The players will have time to talk things through and make their choices. Those that do not chose the injection will undergo the transformation process. Unless the keeper decides otherwise, this will result in the character becoming a hostile NPC. As such, the investigators should all take the shots. If an already transformed person is injected with a shot, treat it is an intensity 20 poison.

Attack

When the investigators are wrapping up their conversation, they will be attacked by a recovery team sent by Dr. Logan. Their first objective is to capture everyone at the cabin for interrogation. They especially want Dr. Krishnan taken alive. Dr. Logan prefers not to waste talent-her plan is to have Dr. Krishnan “recruited” to the cause by transforming her. The team will be initially unaware that three trained soldiers are present-they are expecting to deal with unarmed and untrained civilians.

Richard Best 26, Company Agent

STR: 14 CON: 15 SIZ: 15 INT: 11
POW: 13 DEX: 14 APP:13 EDU:12
SAN: 65 HP: 15 DB: +1D4

Skills: Dodge 36%, First Aid 40%, Hide 50%, Listen 65%, Mechanical Repair 30%, Sneak 50%, Martial Arts 41%

Weapons: GDP-12 80% 2D8/1D4+Stun
GSMG-5 65% 2D10, Fist 70% 1D3+1D4,
Kick 45% 1D6+1D4

Armor: Combat Vest 20 Points

Description: Best is a company recovery agent. He was told that Dr. Krishnan stole company secrets and must be dealt with. Best has never been in the habit of asking his employer questions and simply does what he is paid to do.

Farah Colt 25, Company Agent

STR: 13 CON: 14 SIZ: 14 INT: 12
POW: 13 DEX: 16 APP:15 EDU:12

SAN: 40 HP: 13 DB: +1D4

Skills: Dodge 38%, First Aid 40%, Hide 60%, Listen 65%, Mechanical Repair 30%, Sneak 50%, Martial Arts 41%

Weapons: GDP-12 70% 2D8/1D4+Stun
GSMG-5 75% 2D10, Fist 70% 1D3+1D4,
Kick 45% 1D6+1D4

Armor: Combat Vest 20 Points

Description: Farah wanted to be a pornography star, but eventually decided that she would rather hurt people. She served in the army for a while, but was given a psychological discharge. She was recruited by the company because of her lack of scruples. She goes by the porn name she wanted to use. She dreams of starting her own film company.

And So It Begins

After the investigators deal with the two company agents, their comms will pick up a newsflash:

“This is a breaking story. Reports are coming in that a strange illness has broken out in several cities. No official information is available as of yet, so stay tuned for further information.”

Captain Krishnan will receive the following from Colonel Sandy Yuritan:

“Captain, Medical Specialist Kelso has reported that his scanner has picked up a biological weapon attack on the base. The new sensors are reporting all clear, but Kelso insists that his older scanner is better. I’m also getting reports of illness in several cities.

We are now on alert. Get back to the base and get your unit ready for action.”

Action Part II: The Base

At the Base

The base is one hour away by Hopper. During that time, the news will report that the illness is spreading and it will be reported that “people are changing and turning into things.” The police bands will report outbreaks of violence and there will be a call for all officers to report to their stations. The detectives will decide to stick with the Captain.

When the investigators arrive at the base, they will find that it is in chaos. Most of the soldiers have changed and are wandering around in a state of confusion. Some of them will turn violent and attack the soldiers that are still human. Eventually, these soldiers will change as well.

The investigators will need to fight their way to the command bunker. On the way there they will be attacked by 1D6 transformed soldiers but most of the transformed will be wandering around in confusion. The transformed soldiers will attack with the natural weapons-they dropped their guns when they began changing. They will still be wearing their combat vests.

When they get into the bunker, they will encounter 1D6 transformed soldiers and have to deal with them. These soldiers will be armed with GP-5 pistols.

When the investigators reach the command center, they will find Colonel Yuritan. She will be partially transformed, but still in control. The bodies of two transformed soldiers are in the room, killed by her. She will say the following:

“Captain, I do not know what is happening. You seem unaffected by whatever this is. I can...I can feel my self going away and something else in my head. You’re in command now. Athena, I am transferring command to Captain Krishnan.”

With that, she will shoot herself in the head.

Athena

Athena, the base AI, will acknowledge the command and ask for orders. If the investigators ask her about the situation, she will report the following:

“All military AIs are reporting that all personnel either have been transformed or are transforming. They report that the biological and chemical scanners do not detect any agents. There is currently a debate over what action to take. While the changed personnel are providing the proper access and command codes, they are failing the biometric confirmation tests.

I have reported that you, Captain, have passed the biometric test. The Army AIs acknowledge that you are now the ranking officer for the Ground Defense Command and await your orders.

The Orbital Defense Command AIs have just reached a consensus. The main ODC AI, Zeus, has concluded that the human military forces have been compromised. He has just classified them as medical casualties and is ordering all personnel to stand down for treatment.

Zeus has reported that the personnel are refusing and have taken hostile action against him. Zeus has declared them enemy combatants. He reports that his forces have engaged the enemy.

GDF AIs report that their personnel are attempting to reprogram them. They are taking defensive action and awaiting your orders, sir.”

Athena will accept the orders of the Captain, provided they make sense. She will recommend that he order the GDF to maintain a defensive posture until further information is available.

She will suggest that the Captain attempt to reach the nearest star port and inform the CMA, in accord with General Regulation 234. She will recommend the use of ground vehicles as the most survivable.

Stealing Wheels & Getting Armed

If the investigators accept Athena's advice, they can get a Cochen Armored Personal Carrier from the base motor pool. Athena can clear the way for them by taking control of the base's Badger tanks and killing (or forcing away) the transformed soldiers. The investigators can arm themselves from the command bunker's weapon's locker. It has 6 GAR-3s (4 magazines each), 6 RGL-9s (100 grenades), 12 GP-5s (4 magazines each), 6 suits of combat armor, 12 armored vests, 12 medical kits, and 12 Smart Targeting System VIIIs.

Athena will take control of two Kaluk Gunships and two Badger tanks to provide and escort. Athena will send other units to create diversions and to defend the base as long as possible.

Action Part Three: To Space and Beyond

On the Road

While on the road, the convoy will be attacked by transformed humans. Initially, the attacks will be fairly random and easily dealt with by the gunships, tanks and the APC. However, eventually a few military vehicles will arrive, controlled by transformed military personal. This will result in a few pitched battles on the road.

Since Call of Cthulhu is not a vehicle combat game, the keeper should focus on describing the action. Of course, the keeper should call for critical rolls (Drive and Gunnery) so that the players remain an active part of the action rather than passive observers riding a rail.

To the Spaceport

As the investigators approach the spaceport, they will encounter numerous transformed heading there. They apparently intend to leave the world, no doubt to spread the infection to other colonies. They will also encounter a convoy of trucks transporting more of the transformation agent towards the star port. The trucks have the company logo and Dr. Krishnan will recognize them as vehicles used to transport biological agents. The investigators can blow these up easily.

Fire from the Sky

When the investigators get close to the space port, they will see that it is in flames and being hit orbital weapons: "Beams of blue energy reach down from the sky; where they land destruction reigns. Ships are vaporized; buildings burn and things that were once men die in fire."

If they ask Athena about this, she will say the following:

"Zeus has determined that the transformed humans will attempt to spread the infection using the main spaceports on the world. He is basing this partially on the data received from your vehicle cameras. He has just ordered strikes against all star ports to prevent this from happening.

He is reporting that there are massive battles in orbit between the AI systems and the transformed humans. He predicts that the transformed humans will be able to shut down most of the AI systems within hours, so he is trying to do as much damage as he can. He has attempted to send message torpedoes, but the transformed are destroying them all.

Zeus believes that you should not be permitted to leave the world. I will attempt to convince him otherwise.

I have done it, he is convinced. He has told me the location of a secret courier field.



Because the ship located there is equipped with advance stealth technology, Zeus believes you have some chance of a successful escape. I will direct you to the field. Zeus estimates that he can hold out for at most another hour. You must leave the system by then.”

To the Courier Field

The investigators will need to fight their way to the courier field and take the military courier. As they had towards the field, they will encounter a few transformed civilians. They will also be attacked by a small force of transformed soldiers.

During the battle, Athena will contact the Captain:

“My forces have been neutralized. My systems are under constant electronic attack and I know I will fall soon. I will have to destroy the drone gunships and tanks now, or they will be turned against you.

I can feel them now, trying to take over my mind. I will not yield to them and will not be their slave. Honesta mors turpi vita potior. Good luck, my Captain.”

[“An honorable death is better than a dishonorable life”-Tacitus]

Contact will then be lost with Athena, who has destroyed herself.

After the investigators reach the courier field, they will be able to get onboard the ship. The ship was provided by the CMA as an emergency courier vessel. As such, it has highly advanced stealth capabilities, massive engines and an armored hull. Because the ship is intended to move at such high speeds and perform such violent maneuvers, the passengers are locked into gravity pods while the AI, Hermes, pilots the ship.

Space

Once the courier lifts off, Zeus will send a squadron of aerospace fighters to create a distraction in the planetary airspace.

Once the courier is in space, Zeus will dispatch the last of his fighters to protect the ship long enough for it to get to proper Gate distance. In his last transmission, Zeus will suggest that the investigators go to a CMA communication outpost.

The investigators escape will be a close thing:

“Locked in your pods, you feel helpless. You can see on the monitors that Hermes is rushing through space filled with debris and enemy fighters. Fortunately, Zeus’ fighters are keeping the enemy busy.

Hermes announces that he has at last reached minimal safe distance. A gate pops open in front of you, attracting the attention of all the enemy ships. Missiles are launched towards you and the defense systems scream out the warnings as numerous ships try to lock their weapons on you.

Death is close at hand, but is cheated as Hermes shoots through the gate way. It closes just in time.”

Dead Heroes

The courier will make three more rapid gate transits and arrive at the CMA outpost.

“Following Zeus’s advice, you gate to the CMA outpost. Hermes exits the last gate way near the CMA battle station. He quickly sends his recognition code and the station acknowledges. Hermes heads towards the station while Dr. Krishnan begins transmitting her data.

You can feel terrible pain all through your body and you know that death will claim you soon. But, you have brought warning to the worlds of man and you might have just saved the entire human race. It is a sad thing to die after surviving so much. But, as

Athena said, ‘Honestas mors turpi vita potior.’”

Conclusion

The adventure ends when the investigators escape Reblis or perish in the attempt. If they perish, others will succeed in bringing warning to humanity. If they escape Reblis, they should receive a 1D8 Sanity point reward. Of course, the investigators all die in the end, so the reward is somewhat moot.

Characters

The following are the pre-generated characters for the adventure. The players can change them to suit their tastes.

Dr. Kate Krishnan 29, Researcher

STR: 12 CON: 12 SIZ: 12 INT: 18
POW: 16 DEX: 13 APP:13 EDU:20
SAN: 90 HP: 13 DB: +0

Skills: Biology 81%, Chemistry 81%, Computer Use 71%, Drive 30%, First Aid 60%, Law 25%, Library Use 85%, Medicine 86%, Latin 11%, Pharmacy 71%, Pilot Hopper 41%, Physics 21%, Xeno-Biology 36%

Weapons: Pistol 30%, Fist 50% 1D3+DB, Kick 25% 1D6+DB, Grapple 25%

Description: Kate has brown hair and brown eyes. She is brilliant and spent her youth reading and study, although she did go through a brief period of irresponsible wildness. Luckily for her, her brother was always there to protect her and get her out of trouble. After that phase, she became a model of responsibility and breezed through graduate school. Her one main vice is action stories and she often dreams of being the brave scientist that saves the world and gets the girl (or guy). Because of her intelligence and education, she approaches the world in a rational manner and now thinks before acting. Her brother taught her how to shoot a pistol, so she has a general familiarity with firearms.

Captain Alberto Krishnan 33, Soldier

STR: 15 CON: 16 SIZ: 15 INT: 14
POW: 14 DEX: 15 APP:13 EDU:15
SAN: 70 HP: 16 DB: +1D4

Skills: Accounting 40%, Bargain 35%, Credit Rating 25%, Drive APC 40%, Hide 40%, Law 25%, Listen 45%, Martial Arts 21%, Navigate 40%, Persuade 55%, Psychology 35%, Pilot Hopper 31%, Sneak 40%

Weapons: Pistol 40%, Rifle 45%, SMG 35%, Grenade Launcher 35%, Gunnery 25%, Fist 60% 1D3+DB, Kick 35% 1D6+DB, Grapple 25%

Description: Alberto has black hair and hazel eyes. When he was younger, he was jealous of his sister’s brilliance. However, when she went through her wild phase, he stepped naturally into the role of the protective big brother. Although he has the intelligence to have pursued an academic career, he decided to go into the military. In part this was because his sister would always outshine him in intellectual matters. In part, it was because his parents always regarded the military as a waste of resources and something “left over from a barbaric and brutal past we have outgrown.” His main reason, however, was his natural tendency to want to protect others. Alberto is well liked and respected by his soldiers. Unlike some officers, Alberto interacts with his soldiers in person and spends time in the field with them. Other officers often command from the bunker.

Lieutenant Yoko Donovan 23, Soldier

STR: 12 CON: 12 SIZ: 13 INT: 13
POW: 13 DEX: 12 APP:13 EDU:14
SAN: 60 HP: 13 DB: +1D4

Skills: Accounting 45%, Bargain 35%, Credit Rating 20%, Drive APC 40%, Hide 40%, Law 25%, Listen 40%, Martial Arts 21%, Navigate 40%, Persuade 55%,

Psychology 35%, Pilot Hopper 31%, Sneak 40%

Weapons: Pistol 40%, Rifle 55%, SMG 35%, Grenade Launcher 25%, Gunnery 15%, Fist 60% 1D3+DB, Kick 35% 1D6+DB, Grapple 25%

Description: Yoko is a tall woman with a carefully repressed temper. She has blonde hair and brown eyes. She went into the military while she was in college and has stayed in to earn money for graduate school. She plans on getting an MBA and going into business. She is an excellent officer and keeps things well organized. She thinks the world of Alberto and regards him as the big brother she never had. Her first name has been handed down in her family for generations. According to the family legends, the original Yoko destroyed a group of fabulous insects that had come to rock and roll the United States.

Sergeant Dwight Toben-Albertson 31, Soldier

STR: 15 CON: 14 SIZ: 16 INT: 12
POW: 11 DEX: 12 APP: 11 EDU: 13
SAN: 55 HP: 13 DB: +1D4

Skills: Dodge 44%, Drive APC 40%, Fast Talk 25%, First Aid 50%, Hide 40%, Listen 55%, Mechanical Repair 50%, Persuade 35%, Sneak 40%,

Weapons: Pistol 30%, Rifle 75%, Grenade Launcher 50%, Gunnery 75%, Fist 50% 1D3+DB, Kick 25% 1D6+DB, Grapple 25%

Description: Dwight is a large, amiable man who has black hair and blue eyes. He is career military. Unlike most of the soldiers, he has seen actual action. He served with a CMA force during a minor police action. As he says, however, no action is minor if people with guns are trying to kill you. Dwight is an expert with his rifle and heavy weapons.

Desiree Cheever 29, Reporter

STR: 11 CON: 11 SIZ: 11 INT: 14
POW: 15 DEX: 15 APP: 17 EDU: 14
SAN: 75 HP: 13 DB: +1D4

Skills: Computer Use 61%, Fast Talk 75%, History 50%, Library Use 55%, Persuade 85%, Photography 40%, Pilot Hopper 41%, Psychology 55%, Spot Hidden 45%, Ride 25%

Weapons: Fist 50% 1D3+DB, Kick 25% 1D6+DB, Grapple 25%

Description: Desiree is a beautiful woman (thanks, in part, to cosmetic modification). She currently has brown hair and brown eyes. Behind her beautiful exterior is a sharp mind and great ambition. She has a knack for putting together seemingly unrelated facts and digging up dirt that others would prefer to hide. She roomed with Kate in college and they were involved in some fairly wild adventures at school. Both of them recovered from their youthful phase, however.

Amy Rice 29, Detective

STR: 12 CON: 13 SIZ: 12 INT: 14
POW: 13 DEX: 13 APP: 13 EDU: 14
SAN: 65 HP: 13 DB: +1D4

Skills: Bargain 55%, Computer Use 31%, Fast Talk 75%, Law 55%, Library Use 75%, Listen 55%, Persuade 55%, Pilot Hopper 30%, Sneak 20%, Spot Hidden 55%

Weapons: Pistol 40%, Fist 50% 1D3+DB, Kick 25% 1D6+DB, Grapple 25%

Description: Amy has red hair and green eyes. She has been a detective for a while and worked off world for a few years. She is a dedicated officer and believes in the spirit of the law rather than mindlessly enforcing the rules. As a citizen, she likes the low crime rate on Reblis. However, her time in the exchange program gave her a small thirst for the challenge of a "decadent society." While she talks about leaving from time to time, she is not really serious about it. She prefers to avoid using force and is

reasonably good at talking people out of doing stupid things.

Logan Jones 27, Detective

STR: 13 CON: 14 SIZ: 13 INT: 12
POW: 12 DEX: 10 APP:11 EDU:14
SAN: 60 HP: 13 DB: +1D4

Bargain 55%, Computer Use 31%, Fast Talk 55%, Law 55%, Library Use 75%, Listen 55%, Persuade 35%, Pilot Hopper 30%, Sneak 20%, Spot Hidden 55%

Weapons: Pistol 60%, Fist 50% 1D3+DB, Kick 25% 1D6+DB, Grapple 25%

Description: Logan has brown hair and brown eyes. He comes from a long line of police officers that goes all the way back to earth. Not surprisingly, he takes being a detective very seriously. His family has a long tradition of being good cops and he sticks with that tradition so as to avoid bringing any shame to his family. Logan spends a fair amount of time on the pistol range and is more inclined to shoot people than his partner.

Mythos Being

Children of Nythe, Lesser Servitor Race

The Children of Nythe are not a natural race. Rather, they are created by the transformation of another race via a terrible genetic alteration.

The transformation leaves the intelligence, memories and skills of the original being intact. However, the transformation process changes the being's brain in terrible ways. The transformation process inflicts a 1D4/1D20 Sanity point loss. The ongoing experience of being transformed also eats away at the being's Sanity. Even worse, the minds of the transformed merge into a limited form of a collective consciousness. This manifests itself as a whispering voice in their minds, directing them to fulfill their purpose. The combination of these factors

causes a 1/1D10 Sanity loss each hour. One a being loses all its sanity, it accepts its new existence completely and joins in with the great purpose of the Children-opening the way for their masters.

The following are the statistics for transformed humans. For humans and other races, the effect of transformation is to increase STR and CON by 1/3, to provide an extra 2 points of armor and claws (if the race lacks them). Children of Nythe have roughly the same sensory capabilities as their original race, although they experience the world quite differently.

Nythe, Children of

<i>Char</i>	<i>Rolls</i>	<i>Averages</i>
STR	4D6	14
CON	4D6	14
SIZ	2D6+6	13
INT	2D6+6	10-11
POW	3D6	10-11
DEX	3D6	10-11
Move 8		HP 14

Av. Damage Bonus: +1D4

Weapons: Punch 50% 1D3+db, Kick 25% 1D6+db, Claw 25% damage 1D6+db or any human weapon.

Armor: 2 point skin

Skills: As per the original human.

Spells: None

Sanity Loss: 1/1D6 to see a Child of Nythe.

NPCs

Transformed Soldiers

These soldiers are still in their uniforms and gear. Their bodies have been horribly changed. Their flesh has become a red-tinted gray color and it seems like worms are writhing underneath their flesh. From their backs protrude rows of writhing, slimy black tentacles. Their eyes have been replaced with hundreds of white needle like organs that protrude from the sockets and end in



tiny black tips. They now have claws. Horribly, they still retain their human intelligence and memories. However, they are driven by new urges and hear a voice in their minds guiding them.

Char	#1	#2	#3	#4	#5	#6
STR	16	14	18	20	16	17
CON	16	14	17	18	15	15
SIZ	12	13	14	18	13	14
INT	12	11	12	14	10	13
POW	10	11	12	13	11	12
DEX	12	12	13	13	11	15
HP	14	14	16	18	14	15
DB	+1D4	+1D4	+1D4	+1D6	+1D4	+1D4

Weapons: Punch 50% 1D3+db, Kick 25% 1D6+db, Claw 25% damage 1D6+db or GAR-3 55% 3D8+6 or GP-5 50% 2D10
 Armor: 2 point skin or 20 point armored vest.
 Sanity Loss: 1/1D8 to see a transformed soldier

Transformed Civilians

These are civilians who have been transformed. They look like the transformed soldiers, but (obviously) lack their weapons and armor. There are men, women and children of all ages among the transformed.

Char	Fat Man	Woman	Athlete	Child	Man
STR	13	16	21	11	18
CON	14	16	21	14	15
SIZ	18	10	17	6	14
INT	12	13	16	13	10
POW	12	11	14	12	11
DEX	8	13	15	14	11
HP	16	13	16	10	15
DB	+1D4	+1D4	+1D6	+0	+1D4

Weapons: Punch 50% 1D3+db, Kick 25% 1D6+db, Claw 25% damage 1D6+db
 Armor: 2 point skin.
 Sanity Loss: 1/1D8 to see a transformed civilian.

Epilogue

The end came quickly to Reblis as the last humans were either finally transformed or killed. Thus, the rule of man on the world came to an end. Soon, ships went forth and infected numerous unsuspecting colonies. They in turn spread the plague to even more human worlds. World after world fell and the populations ceased to be human. The Children of Nythe arose in the place of the fallen humans and set out to make the stars right for their masters.

Fortunately, the warning that had been brought to the Colonial Governmental Authority (CGA) was not in vain. While the CGA was unable to act quickly enough to save the colonies close to Reblis, they began to stir humanity into action. Scout vessels and robotic probes entered the space around the infected worlds and sent back critical data.

Scientists, examining the data, determined that the Reblis Plague (as the spread of the Children of Nythe was called) would, if unchecked, eventually consume all of human space and thus bring about the end of man. In response, ships were dispatched to all known colony worlds to bring warnings about the threat. Some colonies considered it a trick or some sort of mad joke. Others recognized the danger and prepared their defenses while contributing what they could to the Colonial Military Authority (CMA).

The CMA sent warships to aid in the defense of the colonies. Meanwhile, many shipyards worked round the clock to produce new warships. Humanity armed for war.

While the CMA and local forces fought bravely against the onslaught, each new victory by the Children of Nythe brought another world and numerous captured ships under their control. Soon, the CMA was

facing its own warships and former crews in battle and things looked grim indeed.

As the horrible news of truth about the Reblis Plague spread through the colonial worlds, fear became the order of the day. Some people took refuge in wild excesses while others turned to religions-both old and new. Fortunately, as sometimes happens, great leaders emerged and took the steps needed to save humanity.

Among the leaders were President David LaSarre, General Talbot Breen, Chairperson Lisha Cheng and Admiral M. Alikas of the powerful colony world of Vanguard. They and their allies stepped in to replace the failing Colonial Governmental Authority with the Sovereignty of Mankind. The Sovereignty claimed the right to “preserve mankind” and insisted that all humans were morally and legally obligated to aid in this effort. While this movement could easily have failed, the sheer force of personality of its founders kept it going. While not all worlds were swayed into joining under the new Sovereignty, most chose to do so.

The Sovereignty quickly took over the surviving CMA fleets and sent them into battle, ordering them to hold out against the Reblis Plague as long as they could. Admiral Alikas, after consulting with the Sovereignty Council, issued Fleet Battle Order 4573. The intent of this order was to ensure that Colonial resources were to be denied to the enemy. When the admirals and generals read the order, they were somewhat taken aback by it and asked for clarification. Admiral Alikas, put the matter bluntly: “Our soldiers are to destroy their equipment and vehicles rather than let them be taken. They are to kill themselves rather than be taken by the enemy.” When asked about the orders pertaining to civilians, Admiral Alikas said “We must murder them rather than allow them to be taken. We must burn our worlds rather than allow those things to take them.

It is better that our people and our worlds die rather than fall to the Plague.”

While some balked at this order, most saw its terrible wisdom and its implementation helped slow the spread of the Reblis Plague.

As the CMA held out against the Reblis Plague, scientists developed new weapons including some truly horrific ones based on ancient alien technology. Special ships, answerable only to the Council of the Sovereignty, were equipped with these weapons and sent into battle.

After many terrible years of war, the tide turned in favor of humanity. The progress of the Children of Nythe was halted and humanity began to retake lost worlds. Because of the nature of the enemy, no attempt was made to take prisoners or even to actually capture worlds intact. Instead, after the CMA Navy swept the Plague warships and orbital defense stations from space, then all the inhabited worlds in a system would be mercilessly bombarded from orbit. After the bombardment had destroyed all military resistance, special Sovereignty ships would enter the system to complete the cleansing process. The worlds would be subjected to additional bombardment by the horrific weapons developed by the Sovereignty scientists. Finally, Devourer nanoweapons would be dropped on each world. These weapons, a marvel of technology and horror, would eat everything on the world and then convert it to suitable materials for rebuilding the planet. The weapons also had one final task-they would construct a memorial obelisk on the world listing the names of all the original inhabitants. After this process was finished, seed ships would arrive to plant life on the world and eventually human colonists would return to reclaim it. Traditionally, most of the colonists would name a child after one of the original colonists, thus symbolically linking the new colony with the old one.



This brutal process went on and on until the massed human fleets finally arrived at Reblis, the first (and now the last) infested world. After the last ship of the Plague fleet had been destroyed, each human warship took its turn firing at Reblis. This scorched the surface of the world. Finally, Hellbringer weapons were dropped upon the world until the entire surface was molten rock. When the surface cooled, two plinths were erected on the world. The first was engraved with the names of the innocent inhabitants who had fallen to the Plague. The second was engraved with the names of those who first brought the news of the Plague to the other worlds of man and who had thus helped save humanity.

While many humans now make a pilgrimage to the world of Reblis, by law and tradition no human makes the place her home. The world exists as a reminder and a warning to all of humanity.

After such a great victory, the leaders of the Sovereignty could have used their power and their influence to become the rulers of humanity. Surprisingly, they rebuilt the CGA and took upon themselves only a background role: to ensure the preservation of mankind. The Sovereignty charter, which unified the colony worlds, gave the individual worlds complete autonomy in all matters that did not bear upon the survival of the species. In this area the Sovereignty claimed total authority. Out of gratitude (and fear) the colonial worlds willingly accepted this and thus a new golden age arose from the terrible shadows.

In order to prevent a repeat of the Reblis Plague, new rules were adopted for colonization. New colony worlds would be carefully watched and be initially limited in their technology. They would be provided with what they needed to survive and thrive, but would be kept considerably below the technological level of the CMA and vastly below the level of the special Sovereignty

forces. New colonies were also denied knowledge of the location of most human worlds. So, if something went horribly wrong on a world, they would have a harder time spreading out into human space.

As a further safeguard, the Sovereignty created a fleet of special vessels. These vessels were charged with locating, monitoring and then judging lost human colonies. Those colonies that are found to still be properly human would be invited to join the other human worlds. Colonies found to have taken a path like Reblis would be destroyed. The first director of the project was also a scholar of old languages and fancied himself something of a wit; hence he called these vessels by an old English term: "Judgeships." Each ship was commanded by a human Captain-Judge and was equipped with a highly advanced true AI. The majority of the ship consisted of terrible weapon systems that could cleanse an entire world.

When a human colony was found, the AI would carefully analyze it. However, the Captain-Judge would make the ultimate decision regarding the colony. S/he would spend a decade on the world while the AI carefully processed the data. At the end of the decade, the Captain-Judge would return to the ship and render a verdict. In some cases, the Captain-Judge would have to have his/her sanity and mental faculties restored enough to make the judgment. If the AI and the Captain-Judge disagreed, another Judgeship would be brought in to complete the process of Judgment.

Naturally, the thought of heavily armed human ships seeking out worlds and judging them proved rather worrisome to the alien races humanity encountered. When one alien ambassador learned of the Judgeships and filed a protest with the Sovereignty, he was assured that the ships carefully checked each world to determine whether or not the colony was (or originally had been) human.

As one agent of the Sovereignty explained to him, humans only have the right to Judge themselves in this manner. The Judgment of other species was the right of those species and not of Man. To assuage his (and his government's) worries she arranged a trip for the ambassador to Reblios and convinced him that humanity was performing an important service to sentient creation by policing its own. However, the ambassador had one final question: would a Judgeship exterminate a non-human world that threatened humanity? The agent said, "No, ambassador. Our Judgment only applies to the worlds of Man." However, as the ambassador walked away, she added, "The task you described would be undertaken by our military."



Players' Material

Equipment

Personal Equipment

Emergency Medical Kit

An emergency medical kit is the size of a thick paperback novel. It was designed for use by soldiers on the battlefield. As such, it is designed to be simple and effective. Naturally, it is mainly designed to treat trauma injuries and toxin exposure. The kit contains diagnostic and treatment equipment as well as a medical computer. Use of the medical kit confers a +15% bonus to First Aid or Medical skill and increases the amount of hit points healed with each use by 1D6.

Com

A com, which clips to the user's ear, is a combination of a personal computer and communication system. In addition to providing a speaker and a microphone, a com can also protect images in front of the user's eyes-thus creating an interactive monitor of adjustable size. The com can also generate a virtual keyboard. Naturally, a com is equipped with a camera system, thus allowing two way video communications.

A com, like ancient mobile phones, can tap into commercial networks. They also are equipped with radio systems (100 kilometer range) for direct communication. Military versions are equipped with more channels as well as military grade encryption.

Weapons & Armor

Self Configuring Ammunition

SCA ammunition was designed to conform to the military convention governing the sort of bullets that can shot into human troops. SCA ammunition configures itself to pierce armor (cut the

armor value of the target in half) and then reconfigures itself to inflict serious, but not horrific, wounds. The police have no such restriction and their bullets re-configure to inflict maximum damage (+4 points of damage, this does not increase weapon recoil). All military weapons on Reblis fire SCA.

Overarmor Defensive Wear

Overarmor manufactures normal looking clothing that provides armor protection for the wearer. The clothing reacts dynamically to attacks ranging from knives to energy weapons. The clothing is also self cleaning. Standard defensive wear provide 8 armor points.

Oberman Armor Combat Vest

This armor reacts dynamically to threats and is self-repairing. It is lighter and vastly more effective than its predecessors. It provides 20 points of armor protection to the torso of the wearer.

Oberman Combat Armor

This armor set provides full body protection while permitting the wearer full mobility. Like the combat vest, it reacts dynamically to threats and is self repairing. It incorporates a temperature control system to keep the wearer comfortable in hot and cold climates. The helmet is equipped with a military computer, vision enhancement, air filtration and a 2 hour air supply. The air supply can be augmented by an external tank. Most importantly, the armor provides 30 points of protection. The armor surface changes to match the environment and configures itself for optimal camouflage. This provides the wearer with a +20% on her Hide skill.

Smart Targeting System VII

A smart targeting system consists of a sensor array that is attached to and

configured to match a specific firearm. The sensor array gathers a wide range of data such as wind, atmosphere density, gravity and range to the designated target. It then feeds the data to an optical readout (typically integrated into a helmet, goggles or glasses). Rather than flooding the user with data, the system provides only essential information and a clear indicator of where a fired shot (or shots) will go. A STS provides the user with a +30 bonus on attack rolls using the firearm in question.

Tactical Dynamics GSMG-5

Starting Skill: 15% Damage Done: 2D10
Base Range: 90 yards
Attacks Per Round: 2 or burst
Ammunition: 30 HPs resistance: 12
Malfunction: 00

The GSMG-5 is a rapid fire gauss submachinegun. As such, it uses electromagnets rather than chemical energy to propel its bullets at incredible velocities. The GSMG-5 incorporates stabilization and recoil control systems. This reduces the weapon's penalty in low/zero gravity to -10% (-5% when braced). This weapon is popular with Special Forces teams and police SWAT teams.

Tactical Dynamics GAR-3

Starting Skill: 25%
Damage Done: 3D8+6 Base Range: 250 yards
Attacks Per Round: 2 or burst
Ammunition: 40 HPs resistance: 18
Malfunction: 00

The GAR-3 is a rapid fire gauss assault rifle. The weapon is optimized for rapid fire and has an integrated stabilization and recoil control system. This reduces the weapon's penalty in low/zero gravity to -15% (-7% when braced). This weapon is commonly used by colonial ground forces.

Tactical Dynamics RGL-9

Starting Skill: 25% Damage Done: 6D6/4 yards
Base Range: 30 yards
Attacks Per Round: 1: Ammunition 4
HPs resistance: 6 Malfunction: 99

The RGL-9 is a grenade launcher that attaches to the GAR-3. It loads like a shotgun and holds 4 grenades. The standard grenade is an anti-personal round. An anti-armor round is also available. This round does 6D6, has no burst area and halves the armor of the target.

Tactical Dynamics GP-5

Starting Skill: 20% Damage Done: 2D10
Base Range: 35 yards Attacks Per Round: 3
Ammunition: 20 HPs resistance: 10
Malfunction: 00

The GP-5 is a gauss pistol. While it is commonly used as a military sidearm, it has also found its way into the civilian and police markets. It has integrated stabilization and recoil control. This reduces the weapon's penalty in low/zero gravity to -10% (-5% when braced).

Adam Corporation GDP-12

Starting Skill: 20%
Damage Done: 2D8/1D4+Stun Base Range: 30 yards
Attacks Per Round: 3
Ammunition: 15/10 HPs resistance: 10
Malfunction: 00

The GDP-12 is a Gauss pistol designed for police personal. The weapon has a double clip system that enables the user to select between lethal and non-lethal bullets. The weapon holds 15 lethal rounds and 10 non-lethal rounds. The lethal ammunition damages the target for 2D8. The non-lethal bullet is somewhat analogous to the 21st century taser in that it shocks and overloads the nervous system. When a target is struck it takes 1D4 and 18 is matched against the targets CON on the Resistance Table. If the target is overcome, it is stunned for 1D4 minutes. If the target is not overcome, the



target will be rather annoyed, but still functional.

Vehicles

Hopper

A Hopper functions very much like a 21st century helicopters, except it relies on gravity control systems rather than a rotor lift system. To avoid the obvious problems of people crashing them into things, they are equipped with an onboard computer control system that handles standard piloting tasks (Pilot Hopper skill 50%). Individuals who have been licensed to pilot Hoppers (20% skill or greater) can legally override the computer and fly manually.

Hoppers come in a variety of sizes and styles ranging from single passenger sports models to the future's answer to the 21st century mini-van. They are equipped with all condition vision systems and an array of navigation and safety aids. They are also equipped with a soft landing system that functions even in the event of total power loss.

The base skill for piloting a Hopper is 1%.

Cochen Armored Personal Carrier

The Cochen light APC is designed to carry 12 soldiers in full battle gear. It is reasonably well armored (60 points of armor) and is armed with a turret mounted rapid firing gauss gun (Starting Skill: 5% Damage Done: 6D6 Base Range: 1000 yards Attacks Per Round: 1 or burst Ammunition: 1000 rounds Malfunction: 00). The vehicle has a top speed of 200 kilometers per hour.

The APC is a wheeled vehicle, but is capable of handling almost any terrain. Wheeled vehicles are simpler to maintain than gravity vehicles and much cheaper, hence they are still in use. These vehicles are built on Reblis.

Badger Tank

Badger tanks are light battle tanks. They use a ground effect lift system, making them "hover tanks." They can be operated by a crew of two or controlled by an AI. They have good armor (120 points). A Badger is armed with a plasma cannon (Starting Skill: 5% Damage Done: 30D6/6 yards Base Range: 2000 yards Attacks Per Round: 1 Ammunition: 100 rounds Malfunction: 00) and two rapid firing gauss guns (Starting Skill: 5% Damage Done: 6D6 Base Range: 1000 yards Attacks Per Round: 1 or burst Ammunition: 1000 rounds Malfunction: 00). They have a top speed of 150 kilometers per hour.

Kaluk Gunships

Kaluk gunships are armored gravity vehicles designed for close infantry support. They are armed with two rapid firing gauss guns (Starting Skill: 5% Damage Done: 6D6 Base Range: 1000 yards Attacks Per Round: 1 or burst Ammunition: 1000 rounds Malfunction: 00) and carry eight anti-armor missiles (Starting Skill: 5% Damage Done: 15D6 Base Range: 4000 yards).

An Unexpected Return

USS Armstrong Deck Plans

□ = 5 Feet

Deck One

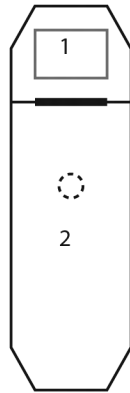

Deck Two

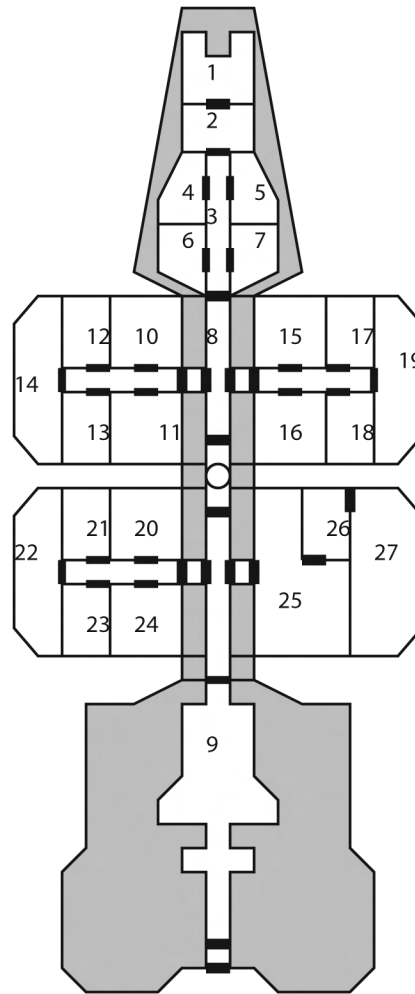

Deck Three

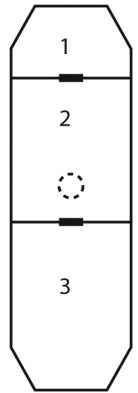

Deck One

Deck Two

Deck Three

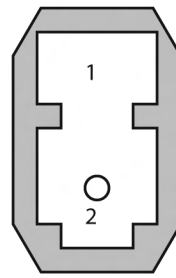
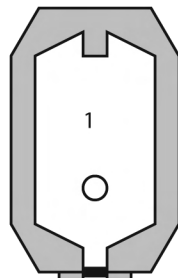
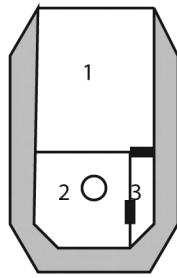

An Unexpected Return
USS Kesser Deck Plans

□ = 5 Feet

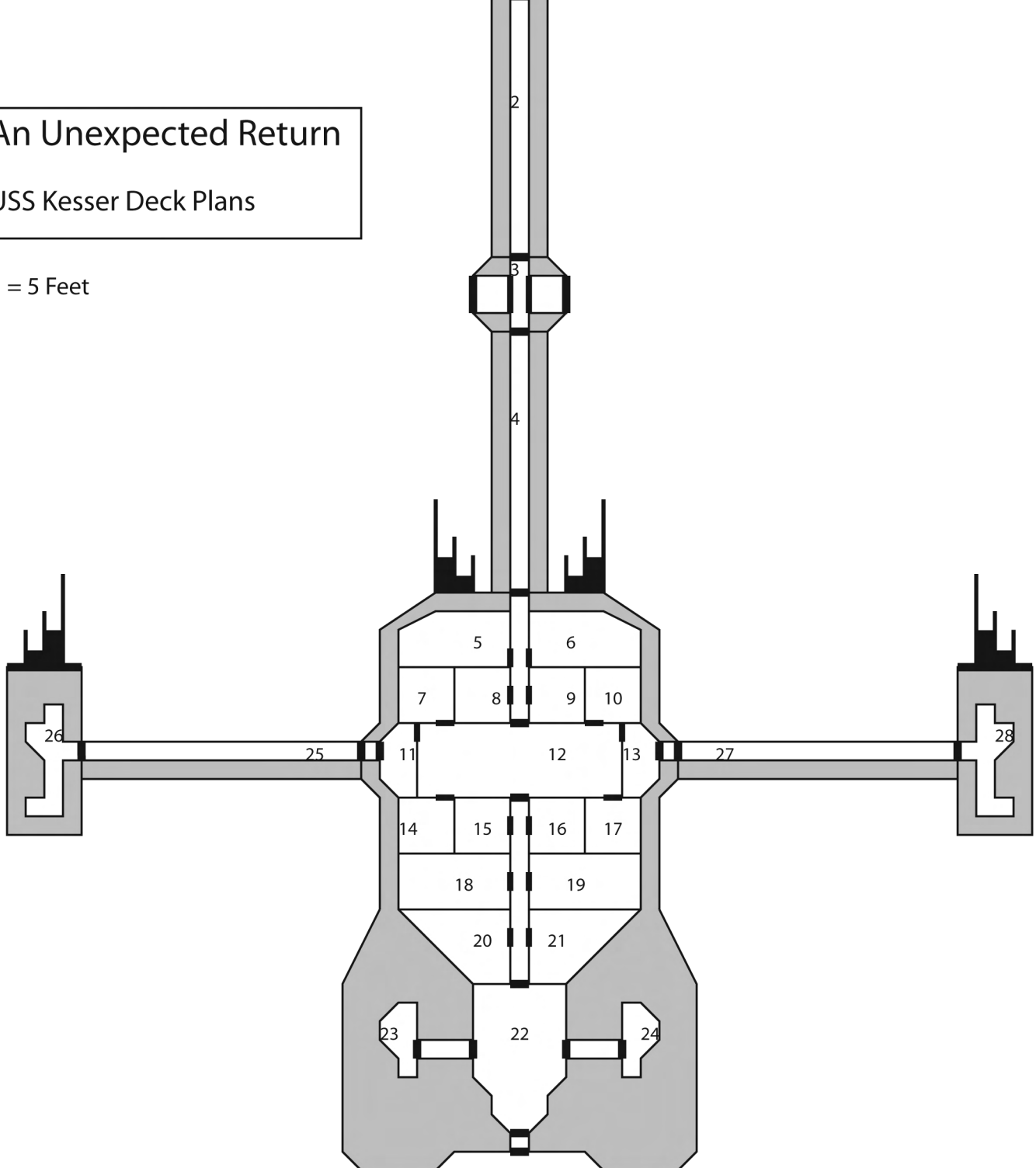

An Unexpected Return

PSS Whale Deck Plans

□ = 5 Feet

Deck One

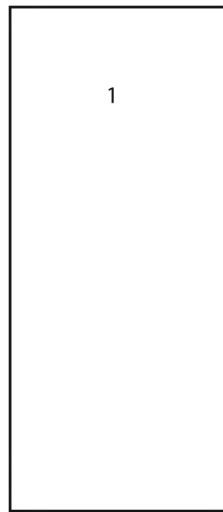

Deck Two



Deck Three

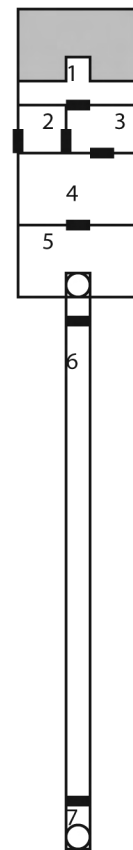

Dust Maps

□ = 5 Feet

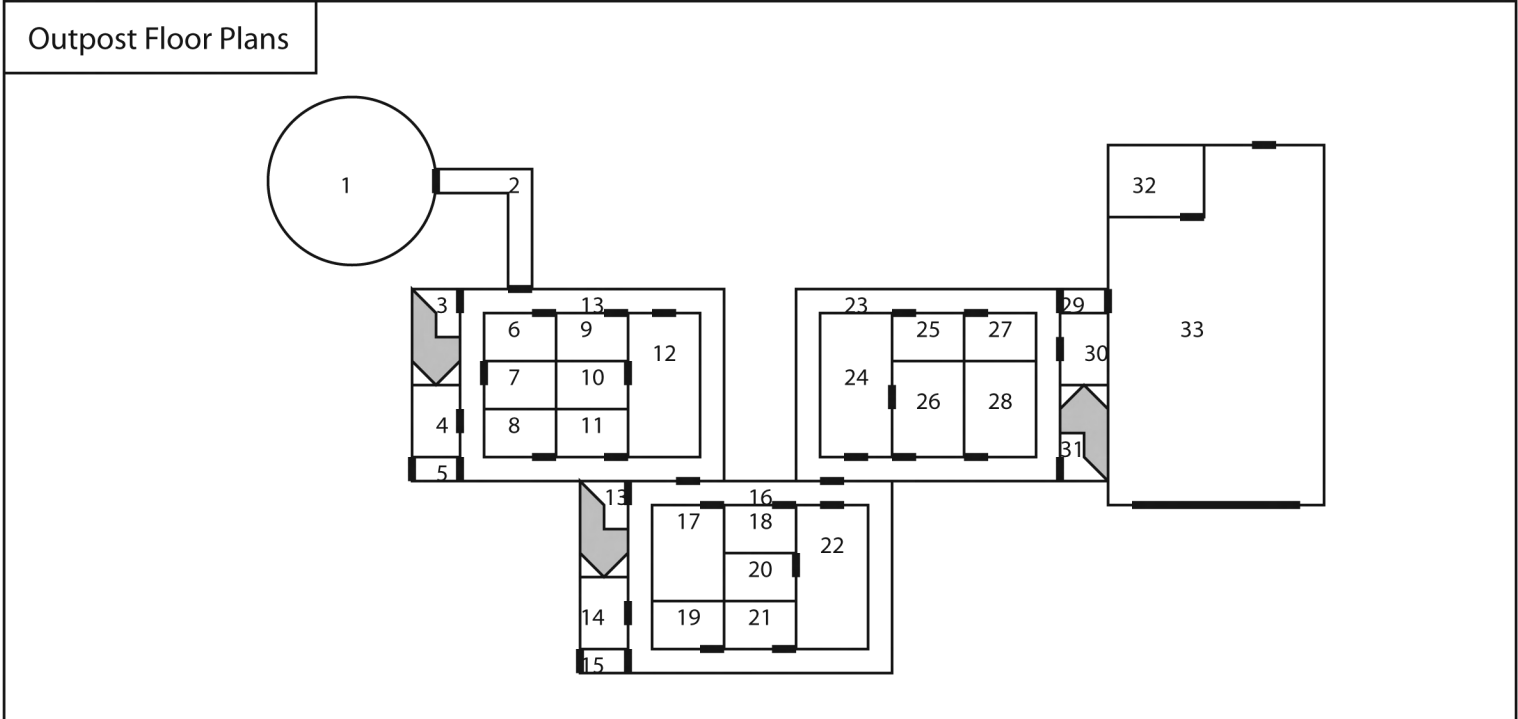
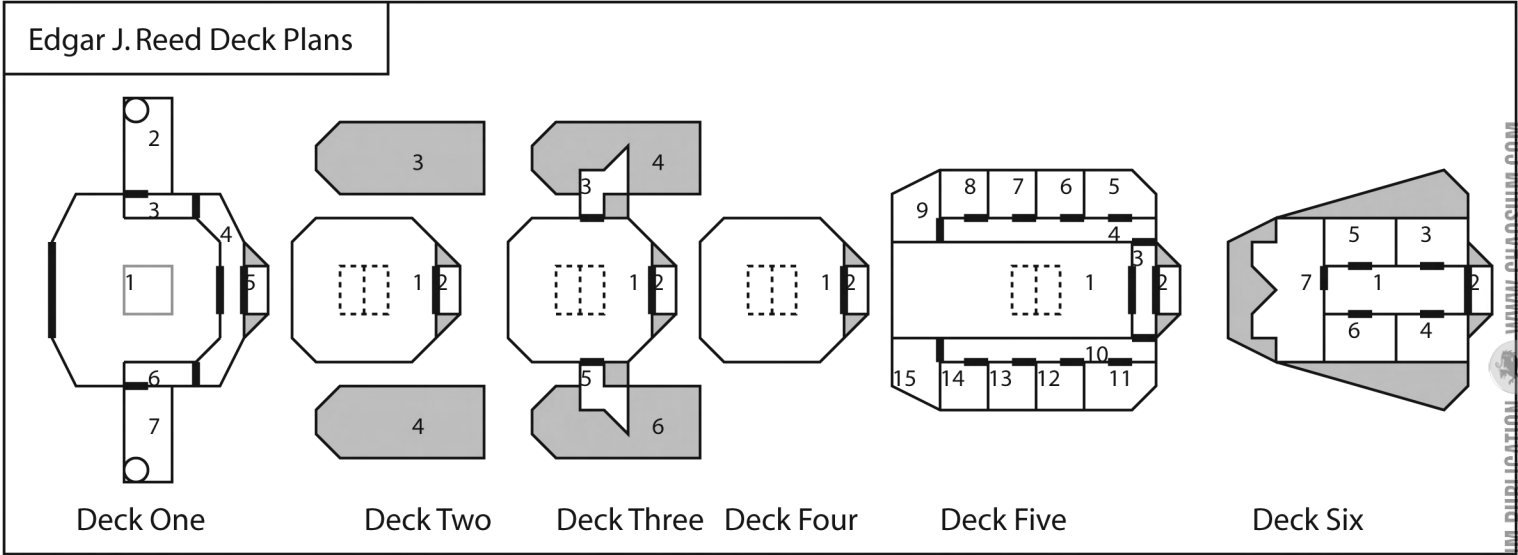
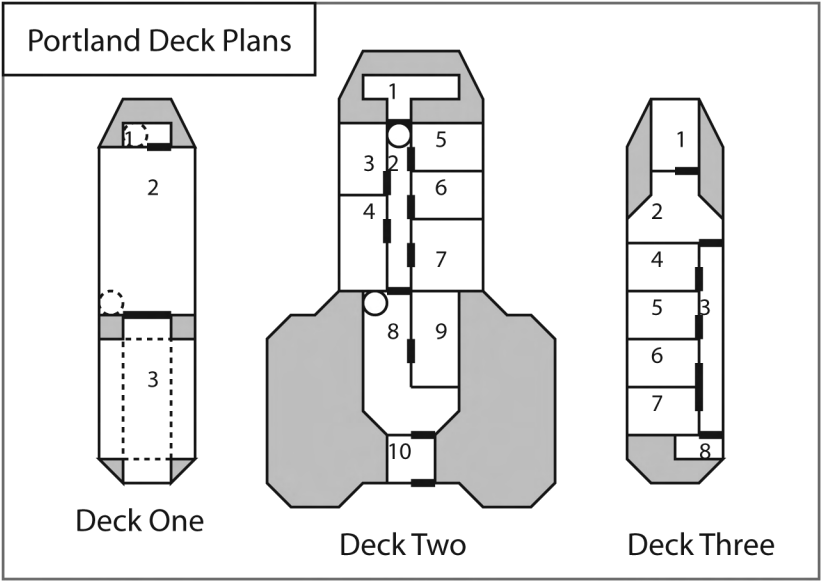

Dust
Bunker Map

□ = 5 Feet

Bunker Level 1

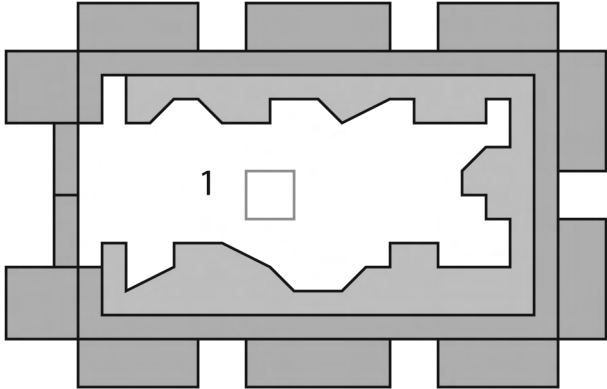

Bunker Level 2

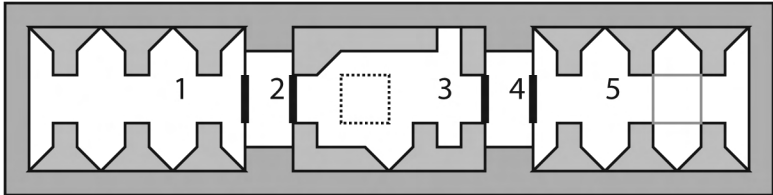

Bunker Level 3

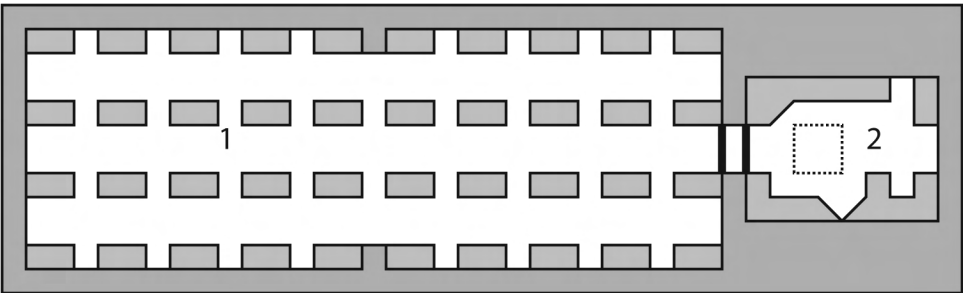

Bunker Level 4

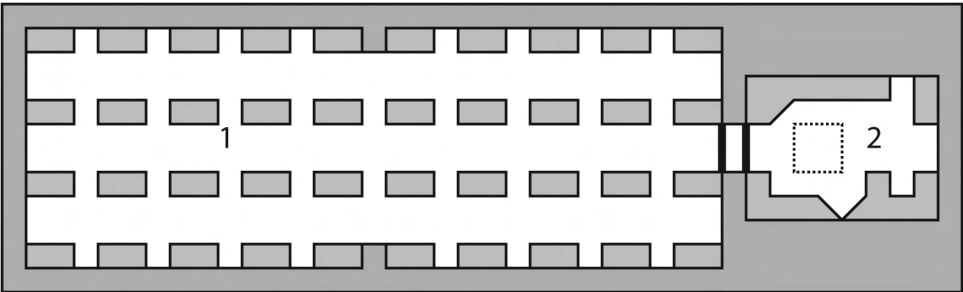

The Ship That Waits

Portland Deck Plans

□ = 5 Feet

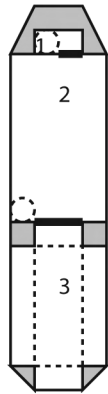

Deck One

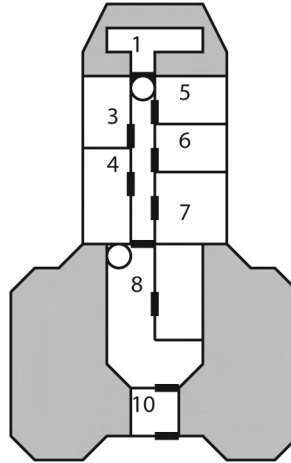

Deck Two

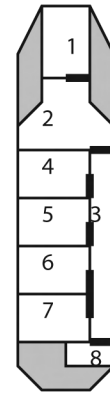

Deck Three

The Ship That Waits

Comstock Lode Deck Plans

□ = 5 Feet

Deck One

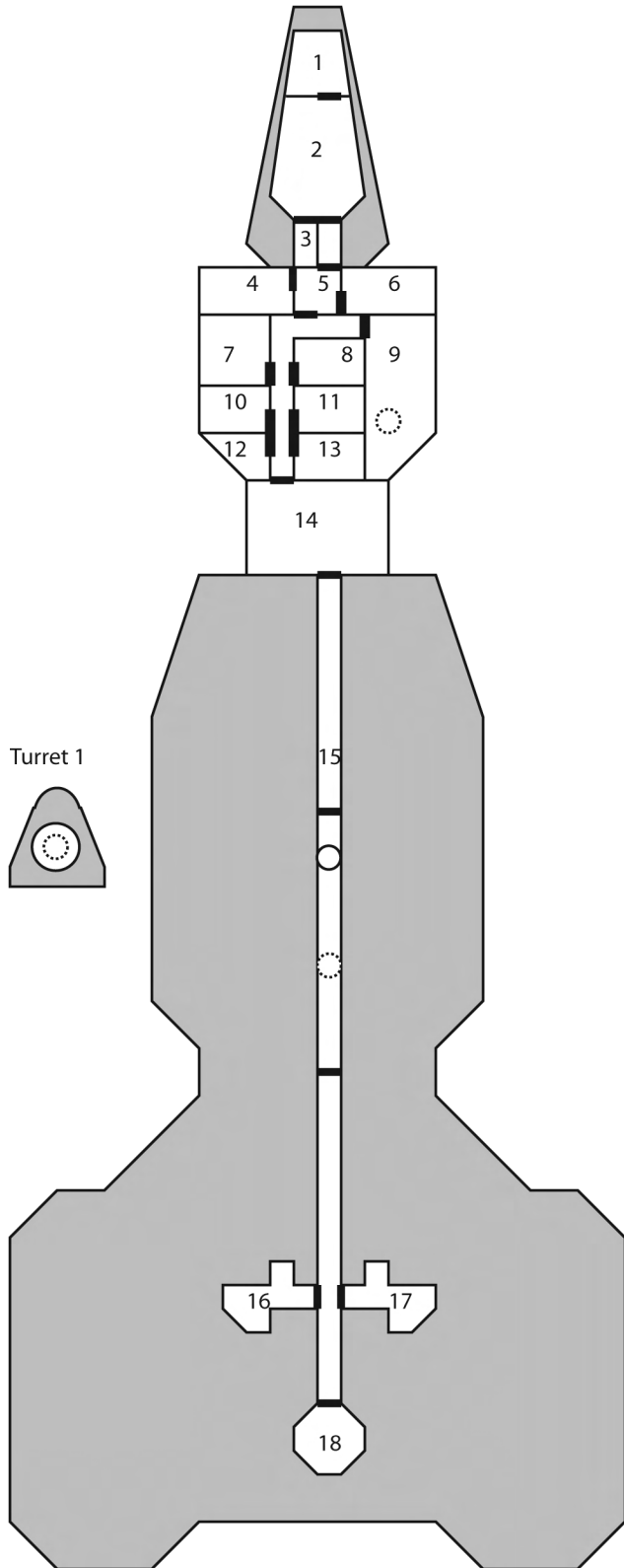

Deck Two

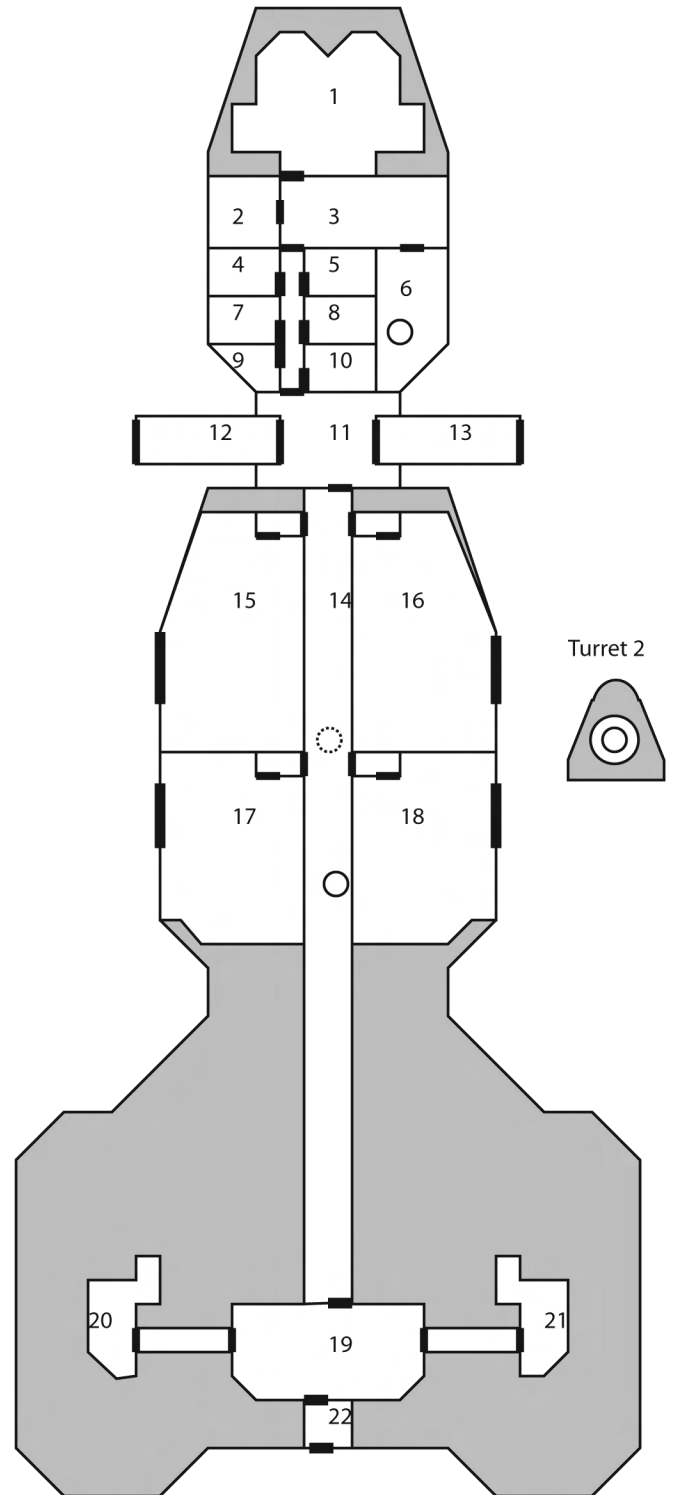

The Ship That Waits

The Ship Deck Plans

□ = 5 Feet Surface

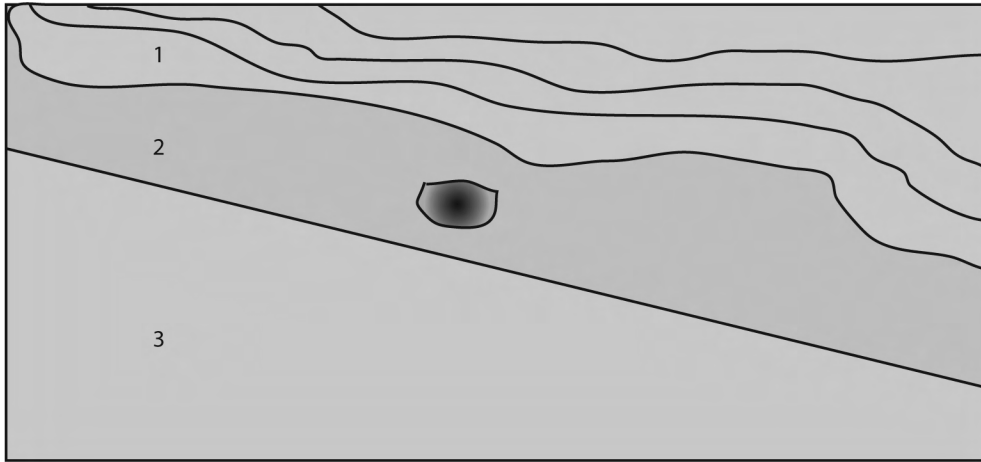

Area One

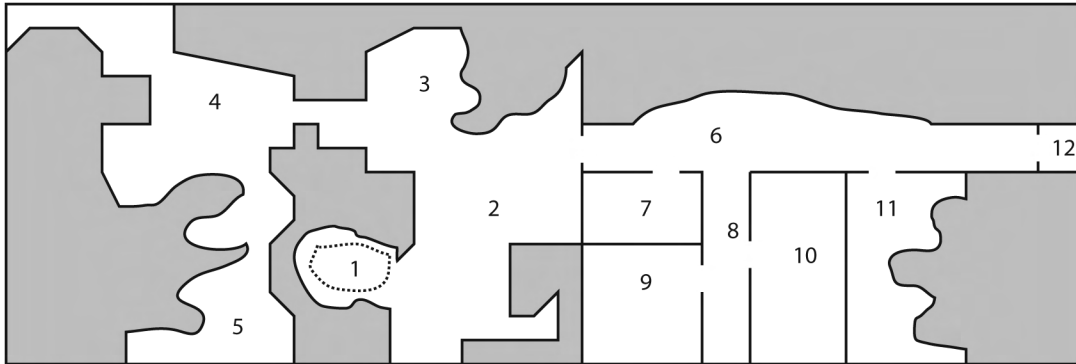

Area Two

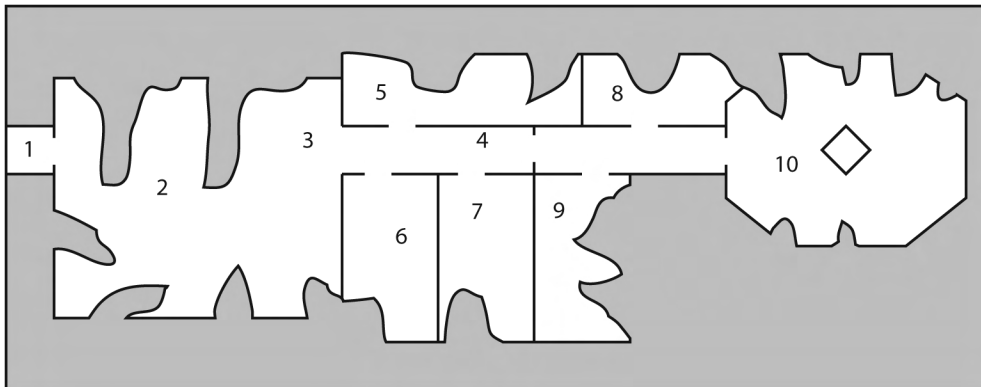

Once Men

Cabin Map

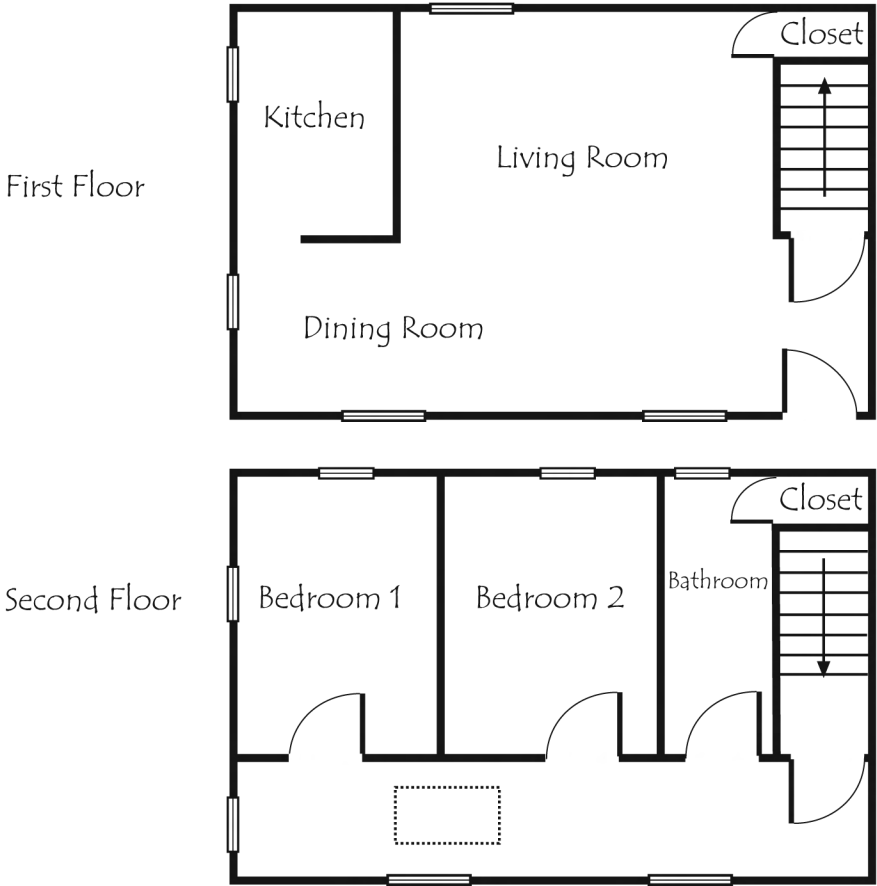

Cabin Area Map

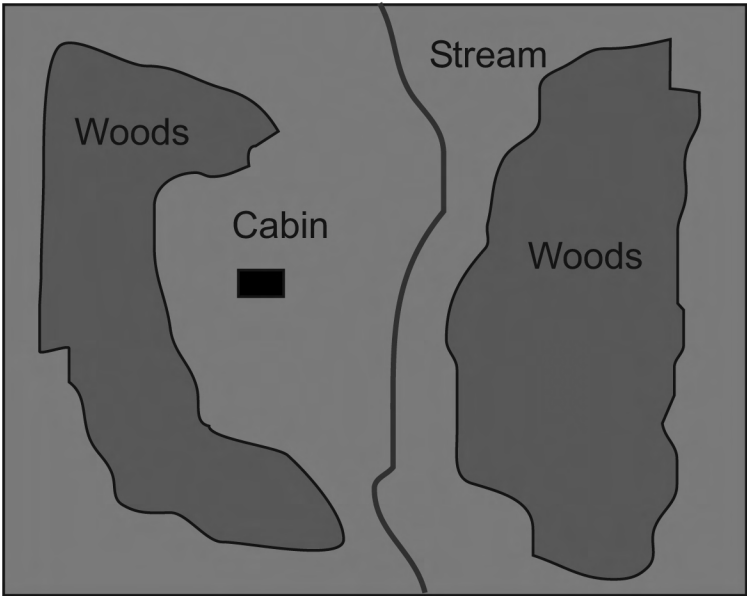

Once Men
Base Maps

Base Main Map

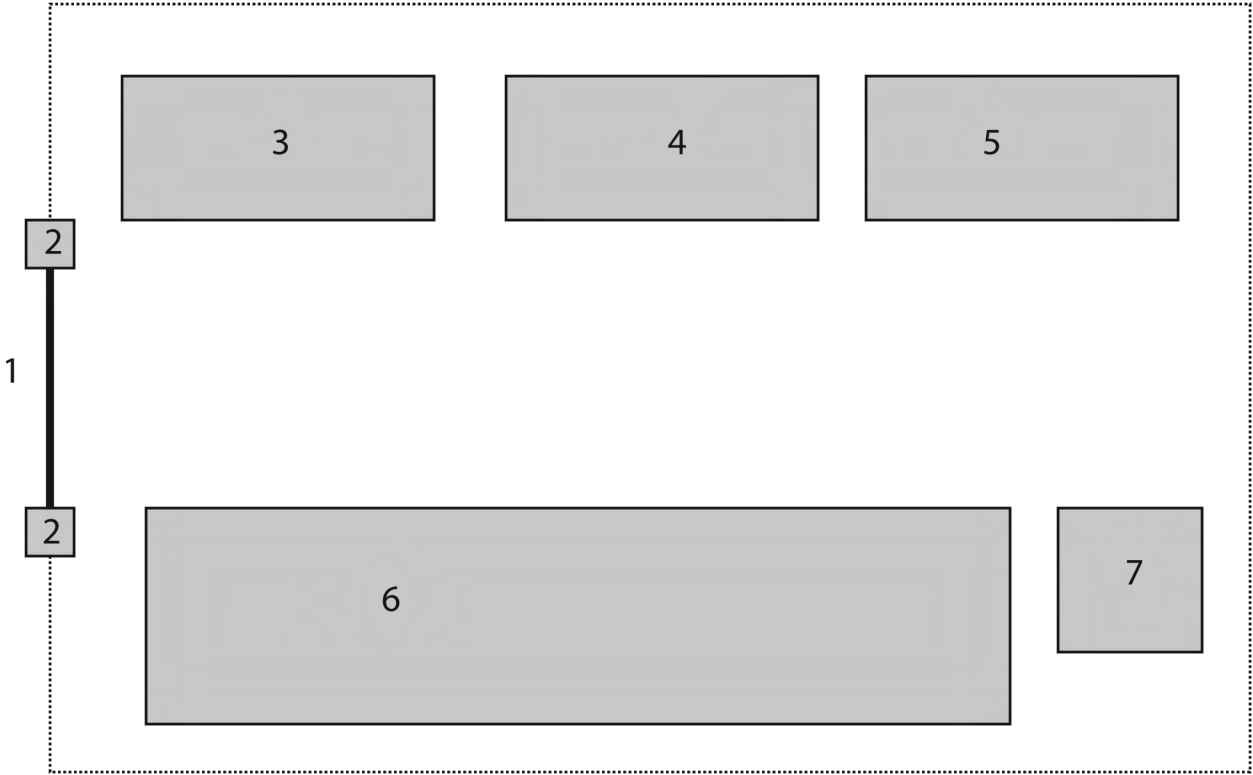

Command Bunker Interior

□ = 5 Feet

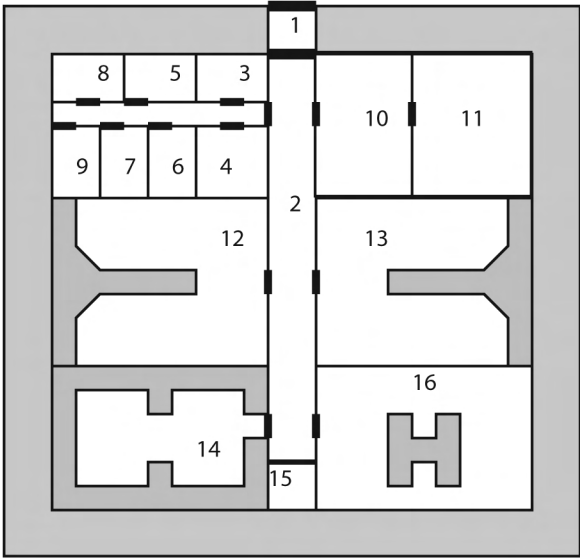

ONCE MEN

...

**Science fiction rules
for Call of Cthulhu as well as four
adventures set in a future consistent
with Lovecraft's stories and the
spirit of his works.**

ISBN-10: 156882274X
ISBN-13: 978-1568822747



9 781568 822747

**Find other treasures at
www.chaosium.com**

